

ILLUMINAZIONE ILLUMINAZIONE ILLUMINAZIONE
ILLUMINAZIONE ILLUMINAZIONE ILLUMINAZIONE
ILLUMINAZIONE ILLUMINAZIONE ILLUMINAZIONE
ILLUMINAZIONE ILLUMINAZIONE ILLUMINAZIONE
ILLUMINAZIONE ILLUMINAZIONE ILLUMINAZIONE
ILLUMINAZIONE ILLUMINAZIONE ILLUMINAZIONE
ILLUMINAZIONE ILLUMINAZIONE ILLUMINAZIONE
ILLUMINAZIONE ILLUMINAZIONE ILLUMINAZIONE
ILLUMINAZIONE ILLUMINAZIONE ILLUMINAZIONE
ILLUMINAZIONE ILLUMINAZIONE ILLUMINAZIONE
ILLUMINAZIONE ILLUMINAZIONE ILLUMINAZIONE
ILLUMINAZIONE ILLUMINAZIONE ILLUMINAZIONE
ILLUMINAZIONE ILLUMINAZIONE ILLUMINAZIONE
ILLUMINAZIONE ILLUMINAZIONE ILLUMINAZIONE
ILLUMINAZIONE ILLUMINAZIONE ILLUMINAZIONE
ILLUMINAZIONE ILLUMINAZIONE ILLUMINAZIONE
ILLUMINAZIONE ILLUMINAZIONE ILLUMINAZIONE



MADE IN ITALY

BOLUCE®
ILLUMINAZIONE



MADE IN ITALY

BOLUCE ILLUMINAZIONE® è una azienda italiana con sede in Bergamo fondata da Gianmario Bosisio nel 1977.

Da 45 anni si occupa della produzione di articoli di illuminazione per esterni ed interni.

I suoi prodotti sono destinati a tutti i mercati mondiali.

Il design delle sue lampade, moderno ed essenziale, si adatta perfettamente ad architetture sia classiche sia contemporanee fornendo ad arredatori ed architetti valide alternative di illuminazione.

Attenta alle nuove esigenze dei mercati, BOLUCE ILLUMINAZIONE impiega oggi LED di ultima generazione accompagnati da avanzate tecnologie.

La produzione è rigorosamente **MADE IN ITALY** e viene realizzata con materie prime e componenti esclusivamente italiani.

La verniciatura in polvere poliestere viene effettuata tramite un processo moderno e altamente qualificato che garantisce la massima resistenza agli agenti atmosferici e all'invecchiamento.

Tutti gli apparecchi sono conformi alle direttive Europee in tema di sicurezza e prestazione.

BOLUCE ILLUMINAZIONE® is an Italian company located in Bergamo founded by Gianmario Bosisio in 1977.

It is since 45 years in the production of luminaires for exterior and interior lighting. Its products are designed for all the world's market.

The luminaires design, modern and essential, suits perfectly to classic and contemporary architectures giving decorators and architects effective alternatives of lighting.

Careful to the new necessities of the market, BOLUCE adopts latest generation LED accompanied by advanced technologies.

























*The production is strictly **MADE IN ITALY** and is made with italian raw materials and components.*

The polyester powder coating is realized by a modern and highly qualified process that guarantees the strongest resistance to atmospheric agents and to ageing.



All the appliances are designed and built according to Safety and Performance European Directives.

INDICE INDEX

APPLIQUE APPLIQUE

	CLARA 51		DORA 55		OLIVIA 55		LINE 59		SLASH 75
	BELT 79		SHARP 83		DM 3 87		DM 4 87		DIXIE 87
	BLUES 97		AMOS 97		N 07 111		BLITZ 111		BLITZ QUAD 111
	HALF 111		DIG 205		SELECTA 243		DUNE 243		INTRO 243
	STICK 263		RAY 263		BLOB 281		MARINA 337		



























PARETE WALL

	COMBO 9		PATH SURFACE 17		LID WALL 45		MAYA 65		ZERO 65
	GAIA 65		LIA 65		PACK 71		BLOCK 107		MEG 107
	DUNE 243		ENCO 259		AIRONE 285		ROSE 285		LOOP 293
	STELLA 293		LEM 293		LASER 303		ASTRA 303		REM 303
	IBIS 313		KAPPA 313		ALFA 319		DELTA 319		IRON 319
	LUCY 331		K90 331		BIP 331		MARINA 337		PERLA 341























PROIETTORI FLOODLIGHTS

	TILT 41		GLAM 135		OCEAN SPOT 135		MIA 205		SPRINT 211
	SPARK 211								















PALI BOLLARD

	LID WALL STELO 45		SLASH STELO 75		SHARP 83		DM 3 STELO 87		DM 4 STELO 87
	DIXIE STELO 87		SPARK STELO 211		MATCH 219		NECK 223		PIN 227
	AKITA 231		GRETA 235		SELECTA STELO 243		DUNE STELO 243		INTRO STELO 243
	LUNA 253		ENCO STELO 259		STICK STELO 263		RAY 263		ARGO 269
	ZEUS 269		ARES INOX 269		ARES 269		ARES 2 269		BLOB 281
	AIRONE STELO 285		IBIS STELO 313						

SOFFITTO CEILING

	COMBO 9		AXEL 29		LARA 29		LENA 29		MIRA 29
	MIRA SYSTEM 29		GAIA 65		LIA 65		MAYA 65		ZERO 65
	PACK 71		BLOCK 107		MEG 107		BLITZ 111		BLITZ QUAD 111
	HALF 111		DUNE 243		LOOP 293		STELLA 293		LEM 293
	LASER 303		ASTRA 303		KAPPA 313		ALFA 319		PERLA 341

INCASSI RECESSED

	NORA 5		COMBO 9		PATH GROUND 23		LID 45		PIXEL 125
	OCEAN 125		DROP 125		GEO 141		HELIOS 159		ADAS 159
	QUAD 165		TREK 175		ZED 175		CLIC 185		DIANA 189
	RITZ 189		STYLE 189		IPSE 189		FLASH 189		GAMMA 189
	INTRO 243		IDA 303						





NORA

NORA

Apparecchio da incasso a soffitto
costituito da:

- Dissipatore e anello in alluminio pressofuso verniciato
- Vetro di sicurezza trasparente
- Lente 24°-38° per cod. 1210-1211
- Riflettore in alluminio satinato ad alta resa luminosa per cod. 1810-1811-1812
- Sistema di fissaggio a molle
- Viti di chiusura in acciaio inox
- Verniciatura in polveri poliestere ad elevata resistenza ai raggi ultravioletti e alla corrosione

Recessed ceiling luminaire
constructed of:

- Painted die-cast aluminium ring and heat sink
- Transparent safety glass
- Lens 24°-38° for cod. 1210-1211
- Satin aluminium reflector with high luminous efficiency for cod. 1810-1811-1812
- Spring fixing system
- Stainless steel screws
- Painting using high resistance to UV and corrosion polyester powders



Colori - Colours

X=2 Bianco
White

X=3 Nero
Black

X=4 Silver

Diffusore - Diffuser

Codice-Code 00 1210

Codice-Code 00 1211

Codice-Code 00 1810

Codice-Code 00 1811

Codice-Code 00 1812

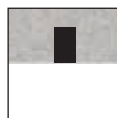

Incasso a soffitto
Recessed ceiling version

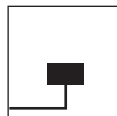

Entrata singola cavi di alimentazione
Single power supply cables input

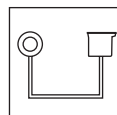

LED
L'apparecchio necessita di alimentatore remoto elettronico (fornito IP20).
The luminaire needs a remote power supply (supplied IP20)

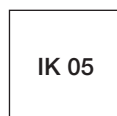

IK 05

**DRIVER
IP65**

Su richiesta
On request

**DRIVER
DALI**

Su richiesta solo IP20
Only IP20 on request



1211 Ø 100
1210 Ø 125

L'apparecchio è fornito di lente.
Disponibile in due ottiche a 24°, 38°.

The luminaire is provided with lens.
Available in two optics 24°, 38°.

• 1211.20.24X	LED COB	9W	1045 lm	4000 K	24°
• 1211.21.24X	LED COB	9W	1020 lm	3000 K	24°
• 1211.20.38X	LED COB	9W	1070 lm	4000 K	38°
• 1211.21.38X	LED COB	9W	1045 lm	3000 K	38°

• 1210.20.24X	LED COB	11W	1533 lm	4000 K	24°
• 1210.21.24X	LED COB	11W	1487 lm	3000 K	24°
• 1210.20.38X	LED COB	11W	1560 lm	4000 K	38°
• 1210.21.38X	LED COB	11W	1510 lm	3000 K	38°

• Con driver remoto IP20 fornito / With IP20 remote driver

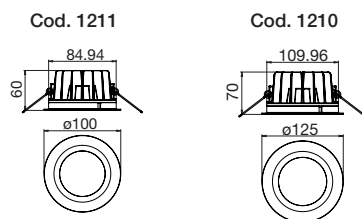

1810 Ø 140
1811 Ø 180
1812 Ø 230

L'apparecchio è fornito di riflettore in alluminio.

The luminaire is provided with aluminium reflector.

• 1810.19X	LED COB	18W	2520 lm	4000 K	50°
• 1810.17X	LED COB	18W	2420 lm	3000 K	50°

• 1811.19X	LED COB	24W	3610 lm	4000 K	70°
• 1811.17X	LED COB	24W	3490 lm	3000 K	70°

• 1812.19X	LED COB	37W	5190 lm	4000 K	90°
• 1812.17X	LED COB	37W	5020 lm	3000 K	90°
• 1812.19.36X	LED COB	37W	5190 lm	4000 K	36°
• 1812.17.36X	LED COB	37W	5020 lm	3000 K	36°

• Con driver remoto IP20 fornito / With IP20 remote driver

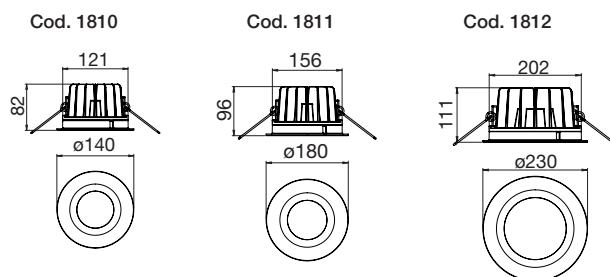

1812 36°



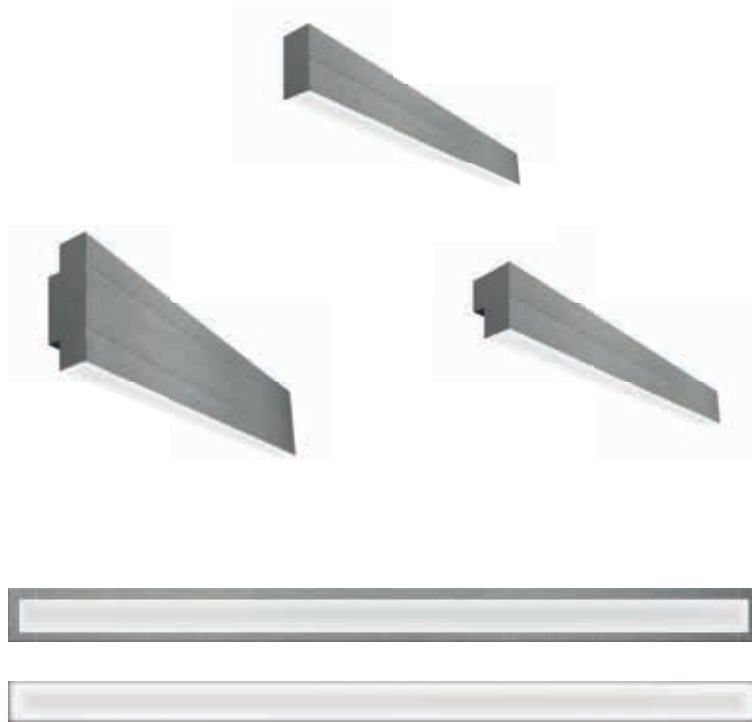

COMBO

COMBO RECESSED

Apparecchio lineare a incasso con LED a luce diffusa per esterni ed interni costituito da:

- Struttura in alluminio estruso verniciato
- LED mid power
- Diffusore in policarbonato ANTI-UV
- Guarnizione in silicone
- Viti di chiusura in acciaio inox
- Verniciatura in polveri poliestere ad elevata resistenza ai raggi ultravioletti e alla corrosione

Outdoor and indoor recessed diffuse light LED luminaire constructed of:

- Painted extruded and die-cast aluminium structure
- LED mid power
- ANTI-UV polycarbonate diffuser
- Silicon gasket
- Stainless steel screws
- Painting using high resistance to UV and corrosion polyester powders



IP66

INCASSO A PARETE
WALL RECESSED

INCASSO A SOFFITTO
CEILING RECESSED

IP67

INCASSO A TERRA
GROUND RECESSED

Colori - Colours

X=2 Bianco White

X=4 Silver

Cod. 5110 - 5111 - 5112

Gli apparecchi vengono forniti completi di cassaforma

The holder is enclosed to the luminaire

**DRIVER
IP67**

Su richiesta
On request

**DRIVER
DALI**

Su richiesta
On request



COMBO GROUND
Incasso a terra
Recessed ground version



COMBO GROUND
Incasso a parete
Recessed wall version



COMBO CEILING
Incasso a soffitto
Recessed ceiling version

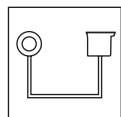

COMBO
L'apparecchio necessita di alimentatore elettronico remoto (fornito solo su richiesta)
The luminaire needs a remote power (supply only on request)



COMBO GROUND
Apparecchio calpestabile max 500 Kg
Walkable luminaire max 500 Kgs



IK 10



Simbolo che indica la temperatura delle superfici toccabili
Symbol indicating the temperature of the touchable surfaces

Temperatura superficie (ta 15°C) Surface temperature (ta 15°C)	Zona di installazione: Intended usage:
LED <40°C	2

NOTA: zona di installazione definita dalla norma EN 60598-2-13 Allegato A - Vedi pag. 348

Note: intended usage is defined by the standard EN 60598-2-13 Annex A - See pag. 348

ACCESSORIO / ACCESSORY : Cod. CN 51
sistema di congiunzione IP68 H₂O STOP
a 2 poli per cavo Ø 5,8 / 6,9 mm - 176 x 30 x 20 mm
IP68 connecting device H₂O STOP with 2 poles
for cables Ø 5,8 / 6,9 mm - 176 x 30 x 20 mm



ACCESSORIO / ACCESSORY : Cod. PT51
Accessorio per mettere a livello più apparecchi in fila continua a terra.
Fitting needed for leveling several appliances in a continuous row.



COMBO INCASSO LINEARE TRIMLESS A TERRA O A PARETE

GROUND OR WALL RECESSED COMBO LINEAR TRIMLESS

Cassaforma obbligatoria

It is mandatory to use the formwork

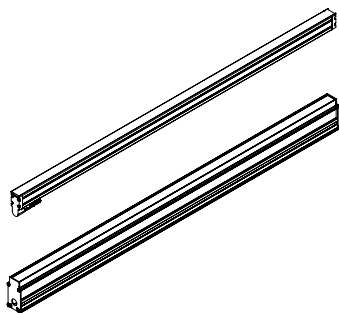

5110 L 500 mm

5110.66X	LED	15W	24V	1850 lm	4000 K
5110.67X	LED	15W	24V	1750 lm	3000 K

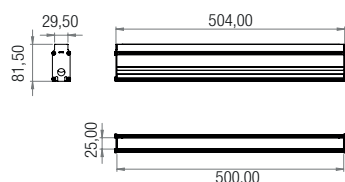

5111 L 1000 mm

5111.66X	LED	30W	24V	3700 lm	4000 K
5111.67X	LED	30W	24V	3500 lm	3000 K

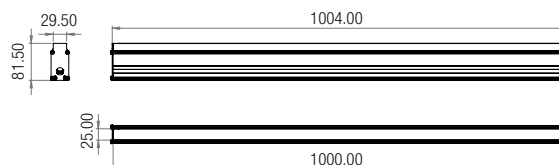

5112 L 1500 mm

5112.66X	LED	45W	24V	5550 lm	4000 K
5112.67X	LED	45W	24V	5250 lm	3000 K

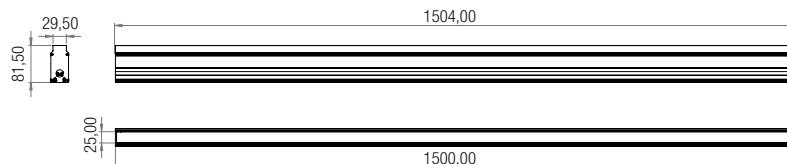

Alimentatore IP67 power supply IP67

Cod. A75

COMBO SYSTEM

COMBO SYSTEM

L'APPARECCHIO COMBO GROUND PUÒ ESSERE INSTALLATO IN FILA CONTINUA PER UNA LUNGHEZZA ILLIMITATA.

COMBO CAN BE INSTALLED IN CONTINUOUS ROW FOR UNLIMITED LENGHT.

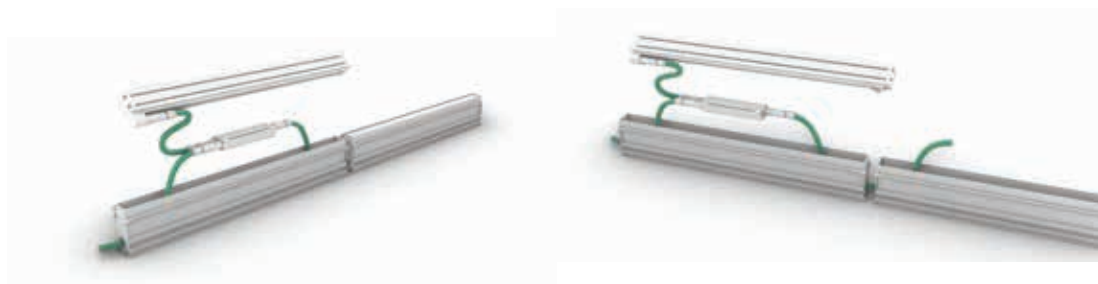

LA CONNESSIONE È FACILE E SICURA CON GLI ACCESSORI DA NOI FORNITI.

SAFE AND EASY CONNECTION WITH THE ACCESSORIES SUPPLIED.

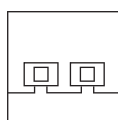

Predisponibile per fila continua
con CN 51 e PT 51
Can be provided for through wiring
with CN 51 and PT 51

ACCESSORIO / ACCESSORY : Cod. PT51

Accessorio per mettere a livello
più apparecchi in fila continua a terra.

Fitting needed for leveling several
appliances in a continuous row.



ACCESSORIO / ACCESSORY : Cod. CN 51

sistema di congiunzione IP68 H₂O STOP

a 2 poli per cavo Ø 5,8 / 6,9 mm - 176 x 30 x 20 mm

IP68 connecting device H₂O STOP with 2 poles

for cables Ø 5,8 / 6,9 mm - 176 x 30 x 20 mm



**UN SEMPLICE CALCOLO PERMETTE DI
STABILIRE LA POTENZA E IL NUMERO
DI ACCESSORI NECESSARI PER LA
REALIZZAZIONE DEL PROGETTO**

A SIMPLE CALCULATION ALLOWS TO
ESTABLISH THE POWER AND THE NUMBER
OF ACCESSORIES NECESSARY FOR THE
REALIZATION OF THE PROJECT



COMBO INCASSO LINEARE TRIM A PARETE O A SOFFITTO

WALL OR CEILING RECESSED COMBO LINEAR TRIM

Apparecchio a incasso installabile su superfici con spessori variabili da 1 a 20 mm

Recessed luminaire for thicknesses from 1 to 20 mm

Sistema di fissaggio a molle

Spring fixing system

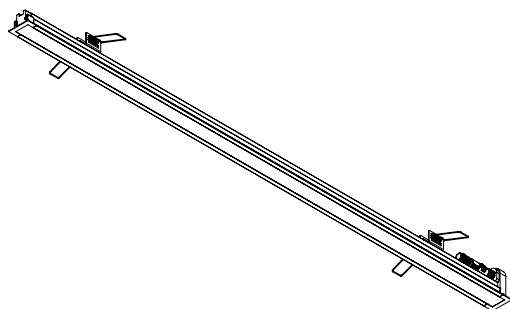
**5150 L 500 mm**

5150.66X	LED	15W	24V	1850 lm	4000 K
5150.67X	LED	15W	24V	1750 lm	3000 K

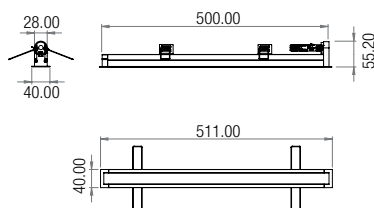

**Foro incasso
500x30 mm**
Recessed hole
500x30 mm

5151 L 1000 mm

5151.66X	LED	30W	24V	3700 lm	4000 K
5151.67X	LED	30W	24V	3500 lm	3000 K

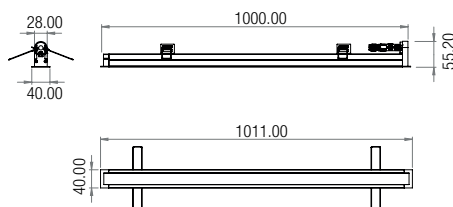

**Foro incasso
1000x30 mm**
Recessed hole
1000x30 mm

5152 L 1500 mm

5152.66X	LED	45W	24V	5550 lm	4000 K
5152.67X	LED	45W	24V	5250 lm	3000 K

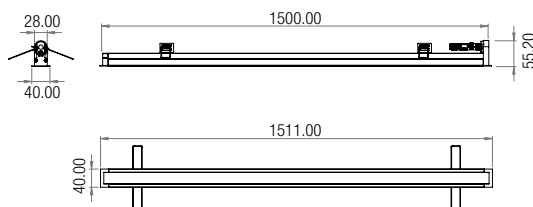

**Foro incasso
1500x30 mm**
Recessed hole
1500x30 mm

Alimentatore IP20 power supply IP20

Cod. A60

COMBO SURFACE

Apparecchio lineare a parete con LED a luce diffusa per esterni ed interni costituito da:

- Struttura in alluminio estruso verniciato
- LED mid power
- **Diffusore in policarbonato ANTI-UV**
- Guarnizione in silicone
- Viti di chiusura in acciaio inox
- Verniciatura in polveri poliestere ad elevata resistenza ai raggi ultravioletti e alla corrosione

Outdoor and indoor wall diffuse light LED luminaire constructed of:

- Painted extruded and die-cast aluminium structure
- LED mid power
- **ANTI-UV polycarbonate diffuser**
- Silicon gasket
- Stainless steel screws
- Painting using high resistance to UV and corrosion polyester powders

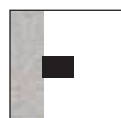

COD. 5120-5121-5130-5131
Installazione a parete
Wall mounting



COD. 5140-5141
Installazione a soffitto
Ceiling mounting

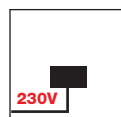

L'apparecchio è fornito completo di alimentatore elettronico 220/240V 50/60Hz posizionato all'interno dell'apparecchio.
The luminaire is supplied with a 220/240V 50/60Hz built-in power supply



Colori - Colours

X=2 Bianco
White

X=4 Silver

COMBO A PARETE - monoemissione / COMBO WALL VERSION - mono-light version



5120 L 500 mm
5121 L 1000 mm

5120.66X	LED	11W	1800 lm	4000 K	220/240V
5120.67X	LED	11W	1750 lm	3000 K	220/240V

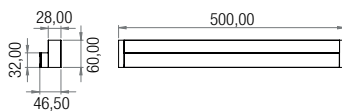

5121.66X	LED	22W	3600 lm	4000 K	220/240V
5121.67X	LED	22W	3500 lm	3000 K	220/240V

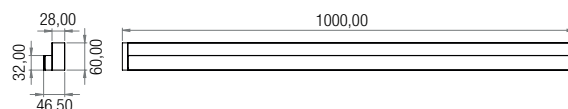

COMBO A PARETE - biemissione / COMBO WALL VERSION - double light version



5130 L 500 mm
5131 L 1000 mm

5130.66X	LED	2x11W	2x1800 lm	4000 K	220/240V
5130.67X	LED	2x11W	2x1750 lm	3000 K	220/240V

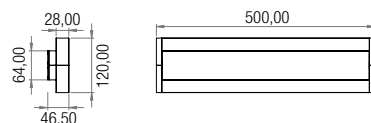

5131.66X	LED	2x22W	2x3600 lm	4000 K	220/240V
5131.67X	LED	2x22W	2x3500 lm	3000 K	220/240V

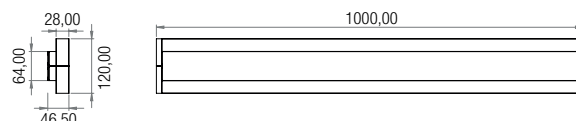

COMBO A SOFFITTO / COMBO CEILING VERSION



5140 L 500 mm
5141 L 1000 mm

5140.66X	LED	11W	1800 lm	4000 K	220/240V
5140.67X	LED	11W	1750 lm	3000 K	220/240V

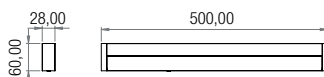

5141.66X	LED	22W	3600 lm	4000 K	220/240V
5141.67X	LED	22W	3500 lm	3000 K	220/240V

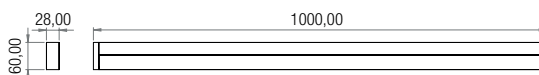

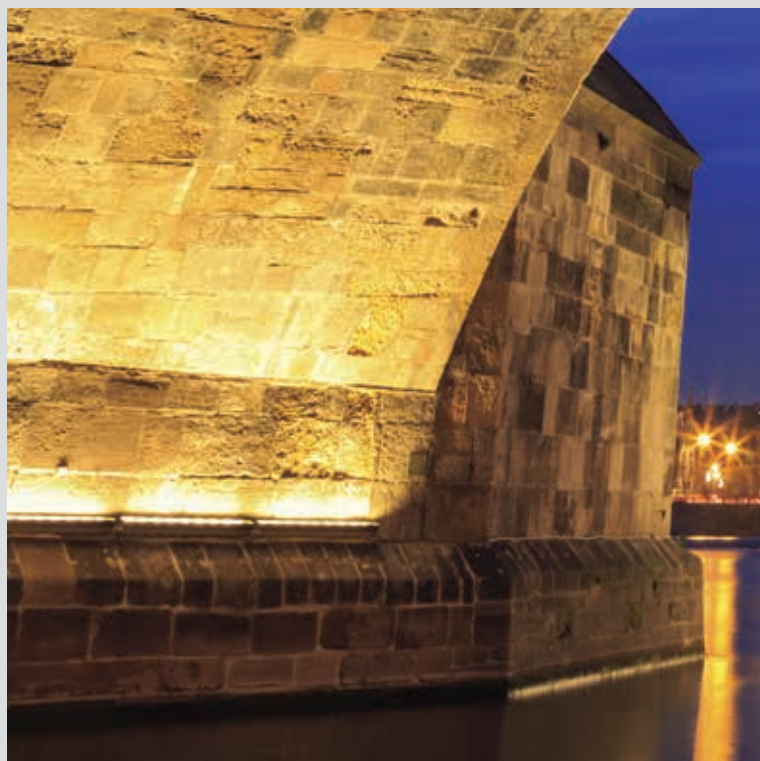

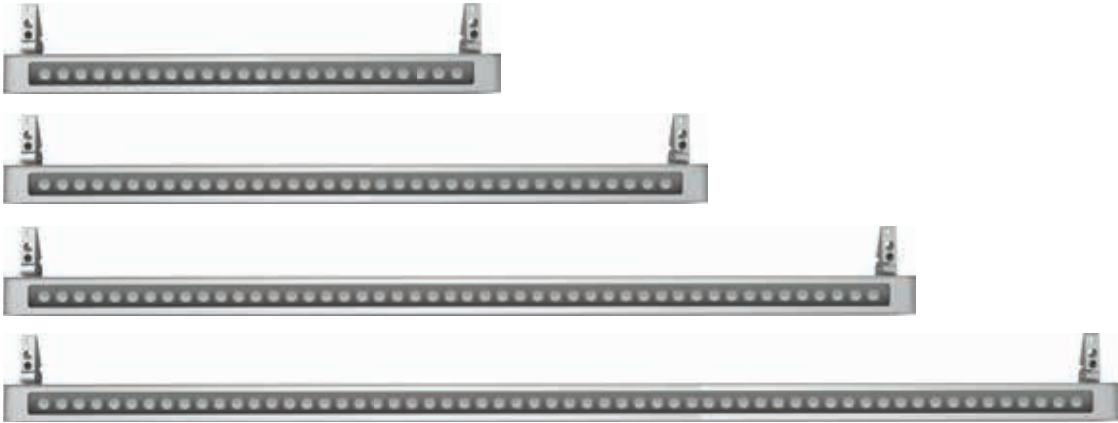

PATH HT SURFACE



PATH SURFACE

PATH HT SURFACE

Apparecchio lineare con LED di potenza a luce diretta per esterni ed interni costituito da:

- Struttura in alluminio estruso e pressofuso verniciato
- Diffusore in vetro temperato trasparente sp. 5 mm
- Ottiche disponibili : 18°, 28°, 64°, 34°+18° ellittica
- Guarnizione in silicone
- Viti di chiusura in acciaio inox
- Verniciatura in polveri poliestere ad elevata resistenza ai raggi ultravioletti e alla corrosione

Outdoor and indoor direct light high power LED linear luminaire constructed of:

- Painted extruded and die-cast aluminium structure
- Transparent tempered glass diffuser 5 mm
- Available optics : 18°, 28°, 64°, 34°+18° elliptical
- Silicon gasket
- Stainless steel screws
- Painting using high resistance to UV and corrosion polyester powders



Colori - Colours

X=4  Silver



Installazione a parete
Wall mounting

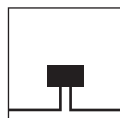

Doppia entrata cavi di alimentazione
Double power supply cables input

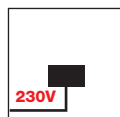

LED
L'apparecchio è fornito completo di alimentatore elettronico 220/240V 50/60Hz posizionato all'interno dell'apparecchio.
The luminaire is supplied with a 220/240V 50/60Hz built-in power supply



IK 09

OPTIONAL

Codice-Code 06-3840
Kit parete
Wall mounting kit

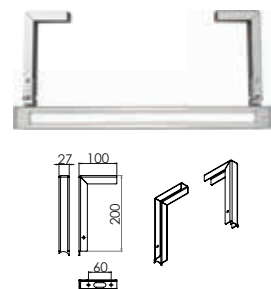

OPTIONAL

Codice-Code CN 22
sistema di congiunzione IP68 H₂O STOP
a 3 poli per cavo Ø 7÷13 mm
IP68 connecting device H₂O STOP with 3 poles for cables Ø 7÷13 mm

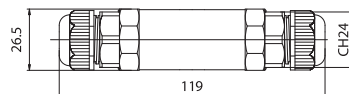

PATH HT SURFACE può essere ruotata di 180° sul piano di montaggio al momento dell'installazione.
PATH HT SURFACE can be rotated 180° on the assembly surface during installation.

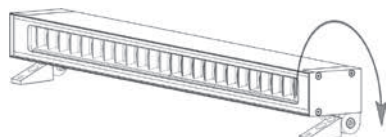

PATH HT SURFACE può essere ruotata di 180° sul piano di montaggio al momento dell'installazione.
 PATH HT SURFACE can be rotated 180° on the assembly surface during installation.

PATH HT SURFACE è disponibile in varie ottiche : 18°, 28°, 64°, 34°+18° ellittica.
 PATH HT SURFACE is available in various optics : 18°, 28°, 64°, 34°+18° elliptical.



3840 L 637 mm - 24 LED

3840.66.184	LED	CRI80	16,5W	2100 lm	4000 K	18°
3840.67.184	LED	CRI90	16,5W	1800 lm	3000 K	18°
3840.66.284	LED	CRI80	16,5W	2100 lm	4000 K	28°
3840.67.284	LED	CRI90	16,5W	1800 lm	3000 K	28°
3840.66.644	LED	CRI80	16,5W	2100 lm	4000 K	64°
3840.67.644	LED	CRI90	16,5W	1800 lm	3000 K	64°
3840.66.EL4	LED	CRI80	16,5W	2100 lm	4000 K	34°+18°
3840.67.EL4	LED	CRI90	16,5W	1800 lm	3000 K	34°+18°

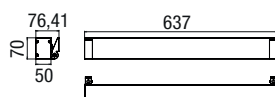

3841 L 922 mm - 36 LED

3841.66.184	LED	CRI80	25W	3100 lm	4000 K	18°
3841.67.184	LED	CRI90	25W	2700 lm	3000 K	18°
3841.66.284	LED	CRI80	25W	3100 lm	4000 K	28°
3841.67.284	LED	CRI90	25W	2700 lm	3000 K	28°
3841.66.644	LED	CRI80	25W	3100 lm	4000 K	64°
3841.67.644	LED	CRI90	25W	2700 lm	3000 K	64°
3841.66.EL4	LED	CRI80	25W	3100 lm	4000 K	34°+18°
3841.67.EL4	LED	CRI90	25W	2700 lm	3000 K	34°+18°

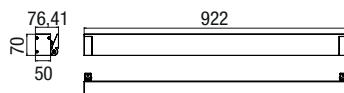

3842 L 1208 mm - 48 LED

3842.66.184	LED	CRI80	33W	4200 lm	4000 K	18°
3842.67.184	LED	CRI90	33W	3600 lm	3000 K	18°
3842.66.284	LED	CRI80	33W	4200 lm	4000 K	28°
3842.67.284	LED	CRI90	33W	3600 lm	3000 K	28°
3842.66.644	LED	CRI80	33W	4200 lm	4000 K	64°
3842.67.644	LED	CRI90	33W	3600 lm	3000 K	64°
3842.66.EL4	LED	CRI80	33W	4200 lm	4000 K	34°+18°
3842.67.EL4	LED	CRI90	33W	3600 lm	3000 K	34°+18°

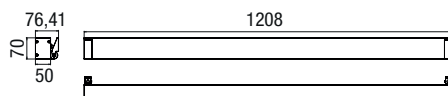

3843 L 1494 mm - 60 LED

3843.66.184	LED	CRI80	41W	5400 lm	4000 K	18°
3843.67.184	LED	CRI90	41W	4500 lm	3000 K	18°
3843.66.284	LED	CRI80	41W	5400 lm	4000 K	28°
3843.67.284	LED	CRI90	41W	4500 lm	3000 K	28°
3843.66.644	LED	CRI80	41W	5400 lm	4000 K	64°
3843.67.644	LED	CRI90	41W	4500 lm	3000 K	64°
3843.66.EL4	LED	CRI80	41W	5400 lm	4000 K	34°+18°
3843.67.EL4	LED	CRI90	41W	4500 lm	3000 K	34°+18°

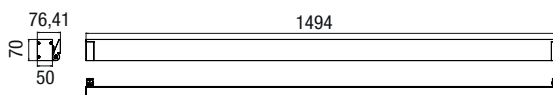

PATH SURFACE

Apparecchio lineare con LED mid power a luce diffusa per esterni ed interni costituito da:

- Struttura in alluminio estruso e pressofuso verniciato
- Diffusore in vetro temperato trasparente con ottica opale sp. 5 mm
- Guarnizione in silicone
- Viti di chiusura in acciaio inox
- Verniciatura in polveri poliestere ad elevata resistenza ai raggi ultravioletti e alla corrosione

Outdoor and indoor direct light mid power LED linear luminaire constructed of:

- Painted extruded and die-cast aluminium structure
- Satin tempered glass diffuser with opal optics 5 mm
- Silicon gasket
- Stainless steel screws
- Painting using high resistance to UV and corrosion polyester powders



Colori - Colours

X=4  Silver



Installazione a parete
Wall mounting

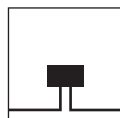

Doppia entrata cavi di alimentazione
Double power supply cables input

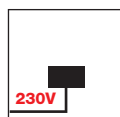

LED
L'apparecchio è fornito completo di alimentatore elettronico 220/240V 50/60Hz posizionato all'interno dell'apparecchio.
The luminaire is supplied with a 220/240V 50/60Hz built-in power supply

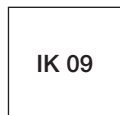

IK 09

OPTIONAL

Codice-Code 06-3840
Kit parete
Wall mounting kit

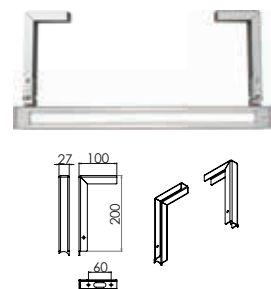

OPTIONAL

Codice-Code CN 22
sistema di congiunzione IP68 H₂O STOP
a 3 poli per cavo Ø 7÷13 mm
IP68 connecting device H₂O STOP with 3 poles for cables Ø 7÷13 mm

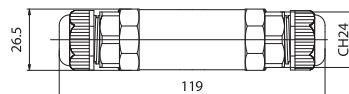

PATH HT SURFACE può essere ruotata di 180° sul piano di montaggio al momento dell'installazione.
PATH HT SURFACE can be rotated 180° on the assembly surface during installation.

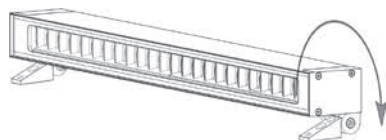

PATH SURFACE può essere ruotata di 180° sul piano di montaggio al momento dell'installazione.
 PATH SURFACE can be rotated 180° on the assembly surface during installation.



3844 L 637 mm - 24 LED

3844.664	LED	CRI80	16,8W	2600 lm	4000 K
3844.674	LED	CRI90	16,8W	2200 lm	3000 K

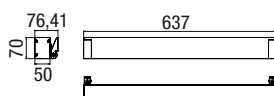

3845 L 922 mm - 36 LED

3845.664	LED	CRI80	25W	3900 lm	4000 K
3845.674	LED	CRI90	25W	3300 lm	3000 K

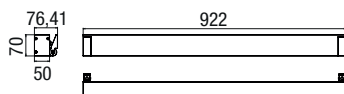

3846 L 1208 mm - 48 LED

3846.664	LED	CRI80	33,6W	5200 lm	4000 K
3846.674	LED	CRI90	33,6W	4410 lm	3000 K

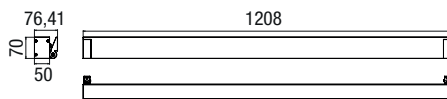

3847 L 1494 mm - 60 LED

3847.664	LED	CRI80	42W	6500 lm	4000 K
3847.674	LED	CRI90	42W	5510 lm	3000 K

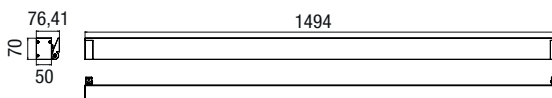

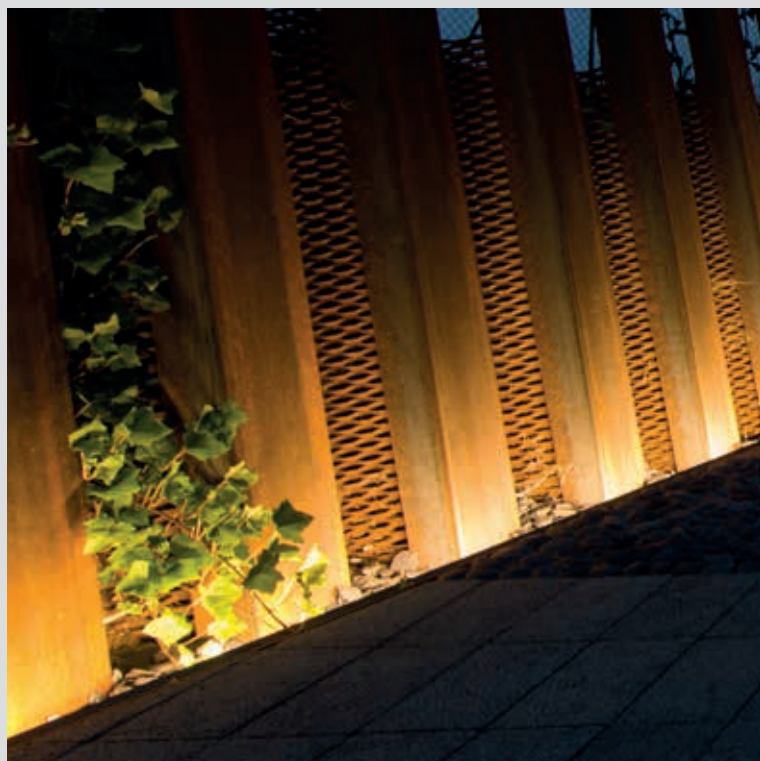

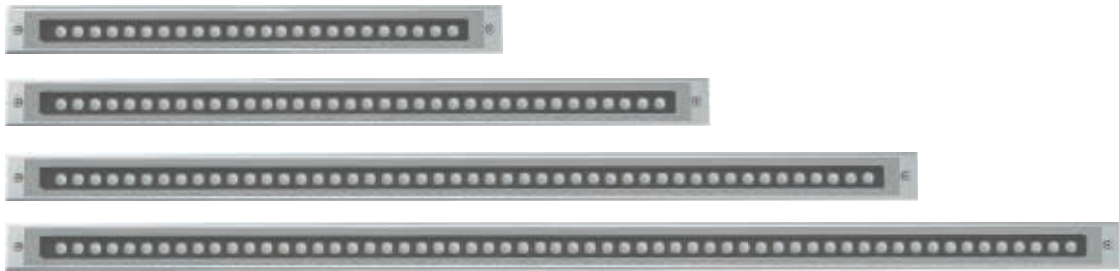

PATH HT GROUND

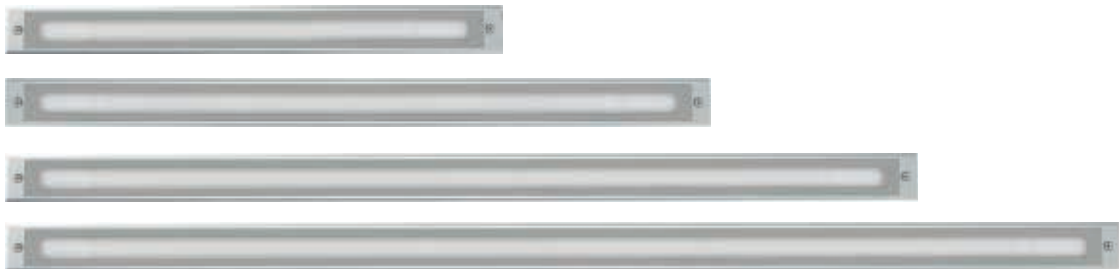

PATH GROUND

PATH HT GROUND

Apparecchio lineare da incasso a terra con LED di potenza a luce diretta per esterni costituito da:

- Struttura in alluminio estruso e pressofuso verniciato
- Diffusore in vetro temperato trasparente sp. 12 mm
- Ottiche disponibili : 18°, 28°, 64°, 34°+18° ellittica
- Guarnizione in silicone
- Viti di chiusura in acciaio inox
- Cassaforma fornita in alluminio pressofuso
- Verniciatura in polveri poliestere ad elevata resistenza ai raggi ultravioletti e alla corrosione

Outdoor linear recessed ground direct light high power LED luminaire constructed of:

- Painted extruded and die-cast aluminium structure
- Transparent tempered glass diffuser 12 mm
- Available optics : 18°, 28°, 64°, 34°+18° elliptical
- Silicon gasket
- Stainless steel screws
- Die-cast aluminium holder included
- Painting using high resistance to UV and corrosion polyester powders



Colori - Colours
X=4 Silver

Gli apparecchi vengono forniti completi di cassaforma
The holder is enclosed to the luminaire

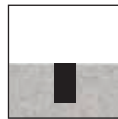

Incasso a terra
Recessed ground version

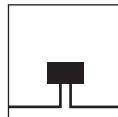

Doppia entrata cavi di alimentazione
Double power supply cables input

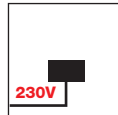

LED
L'apparecchio è fornito completo di alimentatore elettronico 220/240V 50/60Hz posizionato all'interno dell'apparecchio.
The luminaire is supplied with a 220/240V 50/60Hz built-in power supply

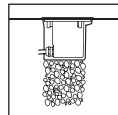

La cassaforma deve essere installata a filo terreno, prevedendo ghiaia di drenaggio per almeno 30 cm.
Ground luminaire. The box must be recessed into the ground providing a drainage-gravel for at least 30 cm.



Apparecchio calpestabile max 1000 Kg
Walkable luminaire max 1000 Kgs



IK 09



Simbolo che indica la temperatura delle superfici toccabili
Symbol indicating the temperature of the touchable surfaces

Temperatura superficie (ta 15°C) Surface temperature (ta 15°C)	Zona di installazione: Intended usage:
LED	2

NOTA: zona di installazione definita dalla norma EN 60598-2-13 Allegato A - Vedi pag. 348

Note: intended usage is defined by the standard EN 60598-2-13 Annex A - See pag. 348

OPTIONAL

Codice-Code CN 22
sistema di congiunzione IP68 H₂O STOP a 3 poli per cavo Ø 7÷13 mm
IP68 connecting device H₂O STOP with 3 poles for cables Ø 7÷13 mm

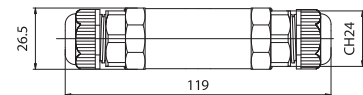

Codice-Code CN 23
sistema di congiunzione IP68 H₂O STOP a 3 poli, 3 vie per cavo Ø 6÷11 mm
IP68 connecting device H₂O STOP with 3 poles, 3 ways for cables Ø 6÷11 mm

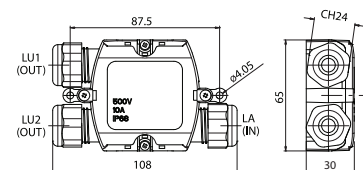

ACCESSORIO / ACCESSORY : art. PT10

Accessorio per mettere a livello più apparecchi in fila continua.
Fitting needed for leveling several appliances in a continuous row.



Su richiesta
On request

DALI

PATH HT GROUND è disponibile in varie ottiche : 18°, 28°, 64°, 34°+18° ellittica.
 PATH HT GROUND is available in various optics : 18°, 28°, 64°, 34°+18° elliptical.



3810 L 654 mm - 24 LED

3810.66.184	LED	CRI80	16,5W	2100 lm	4000 K	18°
3810.67.184	LED	CRI90	16,5W	1800 lm	3000 K	18°
3810.66.284	LED	CRI80	16,5W	2100 lm	4000 K	28°
3810.67.284	LED	CRI90	16,5W	1800 lm	3000 K	28°
3810.66.644	LED	CRI80	16,5W	2100 lm	4000 K	64°
3810.67.644	LED	CRI90	16,5W	1800 lm	3000 K	64°
3810.66.EL4	LED	CRI80	16,5W	2100 lm	4000 K	34°+18°
3810.67.EL4	LED	CRI90	16,5W	1800 lm	3000 K	34°+18°

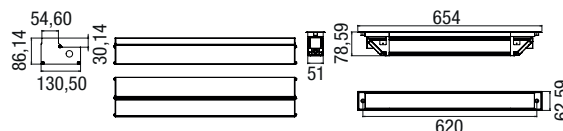

3811 L 940 mm - 36 LED

3811.66.184	LED	CRI80	25W	3100 lm	4000 K	18°
3811.67.184	LED	CRI90	25W	2700 lm	3000 K	18°
3811.66.284	LED	CRI80	25W	3100 lm	4000 K	28°
3811.67.284	LED	CRI90	25W	2700 lm	3000 K	28°
3811.66.644	LED	CRI80	25W	3100 lm	4000 K	64°
3811.67.644	LED	CRI90	25W	2700 lm	3000 K	64°
3811.66.EL4	LED	CRI80	25W	3100 lm	4000 K	34°+18°
3811.67.EL4	LED	CRI90	25W	2700 lm	3000 K	34°+18°

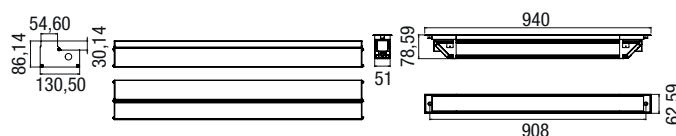

3812 L 1226 mm - 48 LED

3812.66.184	LED	CRI80	33W	4200 lm	4000 K	18°
3812.67.184	LED	CRI90	33W	3600 lm	3000 K	18°
3812.66.284	LED	CRI80	33W	4200 lm	4000 K	28°
3812.67.284	LED	CRI90	33W	3600 lm	3000 K	28°
3812.66.644	LED	CRI80	33W	4200 lm	4000 K	64°
3812.67.644	LED	CRI90	33W	3600 lm	3000 K	64°
3812.66.EL4	LED	CRI80	33W	4200 lm	4000 K	34°+18°
3812.67.EL4	LED	CRI90	33W	3600 lm	3000 K	34°+18°

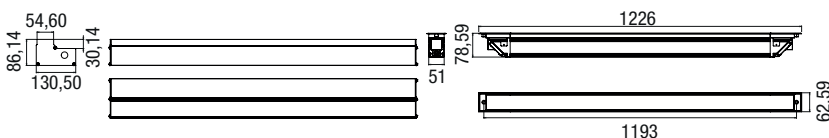

3813 L 1511 mm - 60 LED

3813.66.184	LED	CRI80	41W	5400 lm	4000 K	18°
3813.67.184	LED	CRI90	41W	4500 lm	3000 K	18°
3813.66.284	LED	CRI80	41W	5400 lm	4000 K	28°
3813.67.284	LED	CRI90	41W	4500 lm	3000 K	28°
3813.66.644	LED	CRI80	41W	5400 lm	4000 K	64°
3813.67.644	LED	CRI90	41W	4500 lm	3000 K	64°
3813.66.EL4	LED	CRI80	41W	5400 lm	4000 K	34°+18°
3813.67.EL4	LED	CRI90	41W	4500 lm	3000 K	34°+18°

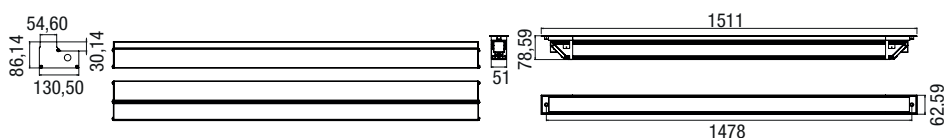

PATH GROUND

Apparecchio lineare da incasso a terra con LED mid power a luce diffusa per esterni costituito da:

- Struttura in alluminio estruso e pressofuso verniciato
- Diffusore in vetro temperato satinato antiscivolo sp. 12 mm
- Guarnizione in silicone
- Viti di chiusura in acciaio inox
- Cassaforma fornita in alluminio pressofuso
- Verniciatura in polveri poliestere ad elevata resistenza ai raggi ultravioletti e alla corrosione

Outdoor linear ground recessed diffuse light mid power LED luminaire constructed of:

- Painted extruded and die-cast aluminium structure
- Satin tempered glass antiskid diffuser 12 mm
- Silicon gasket
- Stainless steel screws
- Die-cast aluminium holder included
- Painting using high resistance to UV and corrosion polyester powders



Colori - Colours

X=4 Silver

Gli apparecchi vengono forniti completi di cassaforma

The holder is enclosed with the luminaire



Incasso a terra
Recessed ground version

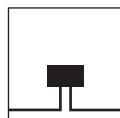

Doppia entrata cavi di alimentazione
Double power supply cables input

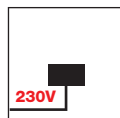

LED
L'apparecchio è fornito completo di alimentatore elettronico 220/240V 50/60Hz posizionato all'interno dell'apparecchio.
The luminaire is supplied with a 220/240V 50/60Hz built-in power supply

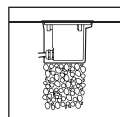

La cassaforma deve essere installata a filo terreno, prevedendo ghiaia di drenaggio per almeno 30 cm.
Ground luminaire. The box must be recessed into the ground providing a drainage-gravel for at least 30 cm



Apparecchio calpestabile max 1000 Kg
Walkable luminaire max 1000 Kgs



IK 09

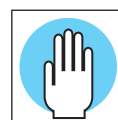

Simbolo che indica la temperatura delle superfici toccabili
Symbol indicating the temperature of the touchable surfaces

Temperatura superficie (ta 15°C)	Zona di installazione:
Surface temperature (ta 15°C)	Intended usage:
LED	2

NOTA: zona di installazione definita dalla norma EN 60598-2-13 Allegato A - Vedi pag. 348

Note: intended usage is defined by the standard EN 60598-2-13 Annex A - See pag. 348

OPTIONAL

Codice-Code CN 22
sistema di congiunzione IP68 H₂O STOP a 3 poli per cavo Ø 7÷13 mm
IP68 connecting device H₂O STOP with 3 poles for cables Ø 7÷13 mm

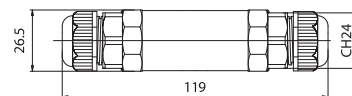

Codice-Code CN 23
sistema di congiunzione IP68 H₂O STOP a 3 poli, 3 vie per cavo Ø 6÷11 mm
IP68 connecting device H₂O STOP with 3 poles, 3 ways for cables Ø 6÷11 mm

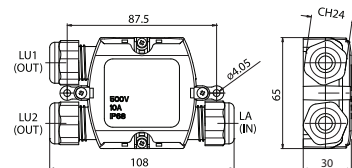

ACCESSORIO / ACCESSORY : art. PT10

Accessorio per mettere a livello più apparecchi in fila continua.
Fitting needed for leveling several appliances in a continuous row.



Su richiesta
On request

DALI



3814 L 654 mm - 24 LED

3814.664 LED CRI80 16,8W 2600 lm 4000 K

3814.674 LED CRI90 16,8W 2200 lm 3000 K

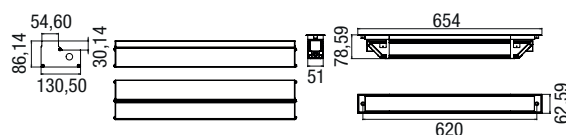

3815 L 940 mm - 36 LED

3815.664 LED CRI80 25W 3900 lm 4000 K

3815.674 LED CRI90 25W 3300 lm 3000 K

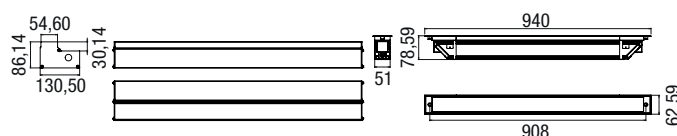

3816 L 1226 mm - 48 LED

3816.664 LED CRI80 33,6W 5200 lm 4000 K

3816.674 LED CRI90 33,6W 4410 lm 3000 K

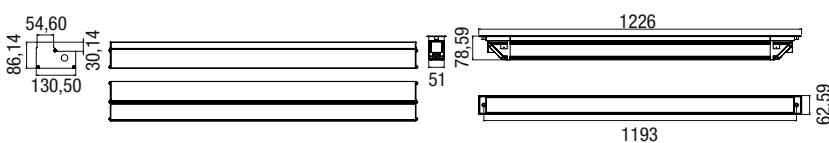

3817 L 1511 mm - 60 LED

3817.664 LED CRI80 42W 6500 lm 4000 K

3817.674 LED CRI90 42W 5510 lm 3000 K

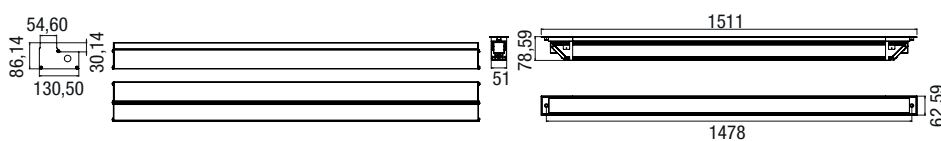

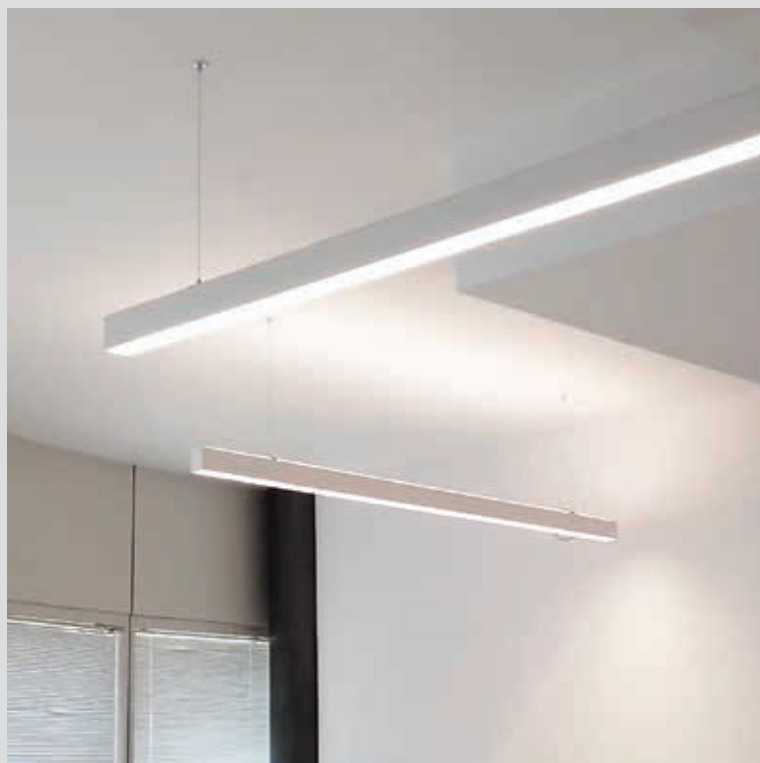



AXEL



LARA



LENA



MIRA



MIRA SYSTEM

AXEL

Apparecchio lineare da esterni e da interni per installazioni a parete, a soffitto o a sospensione costituito da:

- Diffusore in policarbonato opale o trasparente
- LED 3000K o 4000K CRI80
- LED a tensione di rete diretta 230/240V
- Tappo laterale in PVC
- Connettore in entrata e tappo in uscita
- Staffe di fissaggio
- Cavo di alimentazione e dispositivi di sospensione
- Disponibile in due lunghezze 670 mm e 1230 mm

Indoor and outdoor wall, ceiling and suspended luminaire constructed of:

- Opal or transparent polycarbonate diffuser
- LED 3000K o 4000K CRI80
- LED's direct operated at 230/240V
- PVC lateral cap
- Inlet connector and outlet cap
- Fixing system
- Power cable and suspension accessories included
- Available in two lengths: 670 mm and 1230 mm



Colori - Colours

X=2 Bianco White

X=3 Nero Black

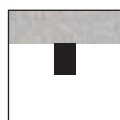

Installazione a soffitto
Ceiling mounting



Installazione a parete
Wall mounting

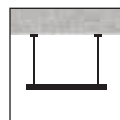

Installazione a sospensione
Suspended installation

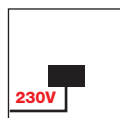

LED
Led a tensione di rete 220/240V 50/60Hz.
Connessione diretta alla rete di alimentazione senza necessità di alimentatore.
LED's direct operation at 220/240V 50/60Hz.
No power supply is required.

MASSIMO NUMERO DI APPRECCHI IN FILA CONTINUA max appliances number in a row		
LUNGHEZZA length	AXEL	AXEL UGR
670 mm	40	37
1230 mm	20	18

AXEL SOSPENSIONE



AXEL 670
AXEL 1230

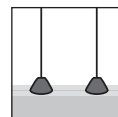

Cod. DS 80
KIT accessori cavi di sospensione
Suspension cable accessories KIT

AXEL PLAFONE



AXEL 670
AXEL 1230

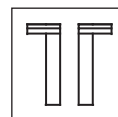

Cod. ST 80
KIT accessori a plafone o a parete
Ceiling or wall accessories KIT

I KIT di sospensione e i KIT da plafone o parete sono forniti come accessori

The suspension KITS and the ceiling or wall kits are supplied as accessories.

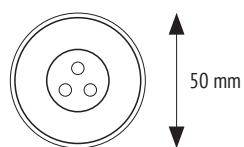

Apparecchio singolo - Single luminaire

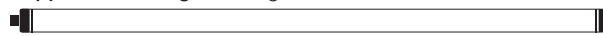

Apparecchio per fila continua - Luminaire for continuous row



Apparecchio con sistema ottico UGR<19 adatto ad illuminazioni architettoniche e per uffici

Luminaire with UGR<19 optical system suitable for architectural and office lighting

Apparecchio singolo - Single luminaire

Diffusore trasparente - Transparent diffuser

7590	L 670 mm	7590.6TRX	LED	CRI80	16W	1750 lm	4000 K
		7590.7TRX	LED	CRI80	16W	1660 lm	3000 K
7591	L 1230 mm	7591.6TRX	LED	CRI80	32W	3500 lm	4000 K
		7591.7TRX	LED	CRI80	32W	3320 lm	3000 K

Apparecchio per fila continua - Luminaire for continuous row

Diffusore trasparente - Transparent diffuser

7540	L 670 mm	7540.6TRX	LED	CRI80	16W	1750 lm	4000 K
		7540.7TRX	LED	CRI80	16W	1660 lm	3000 K
7541	L 1230 mm	7541.6TRX	LED	CRI80	32W	3500 lm	4000 K
		7541.7TRX	LED	CRI80	32W	3320 lm	3000 K

Apparecchio per illuminazione di ambienti industriali (esempio garages, scale, corridoi, pensiline...)

Luminaire for lighting of industrial environments (garages, stairs, corridors, shelters...)

Apparecchio singolo - Single luminaire

Diffusore opale - Opal diffuser

7580	L 670 mm	7580.6OPX	LED	CRI80	11W	1140 lm	4000 K
		7580.7OPX	LED	CRI80	11W	1080 lm	3000 K
7581	L 1230 mm	7581.6OPX	LED	CRI80	22W	2280 lm	4000 K
		7581.7OPX	LED	CRI80	22W	2160 lm	3000 K

Apparecchio per fila continua - Luminaire for continuous row

Diffusore opale - Opal diffuser

7543	L 670 mm	7543.6OPX	LED	CRI80	11W	1140 lm	4000 K
		7543.7OPX	LED	CRI80	11W	1080 lm	3000 K
7544	L 1230 mm	7544.6OPX	LED	CRI80	22W	2280 lm	4000 K
		7544.7OPX	LED	CRI80	22W	2160 lm	3000 K

LARA

Apparecchio lineare a soffitto per interni costituito da:

- Struttura in alluminio estruso verniciato disponibile in due lunghezze 1120 mm e 1680 mm
- Diffusore in policarbonato opale o ottica UGR<19
- Moduli LED 3000K o 4000K CRI80
- Alimentatore integrato in configurazione ON-OFF o dimmerabile DALI
- SDCM Mac Adam 3
- Staffe di fissaggio a soffitto
- Cavo di alimentazione e dispositivi di sospensione
- Verniciatura in polveri poliestere ad elevata resistenza ai raggi ultravioletti e alla corrosione

Indoor ceiling linear luminaire constructed of:

- Painted extruded aluminium structure available in two lengths: 1120 mm and 1680 mm
- Opal polycarbonate diffuser or UGR<19 lenses
- LED 3000K or 4000K CRI80 module
- ON-OFF or dimmable DALI integrated driver LED
- SDCM Mac Adam 3
- Ceiling fixing system
- Power cable and suspension fixing accessories
- Painting using high resistance to UV and corrosion polyester powders

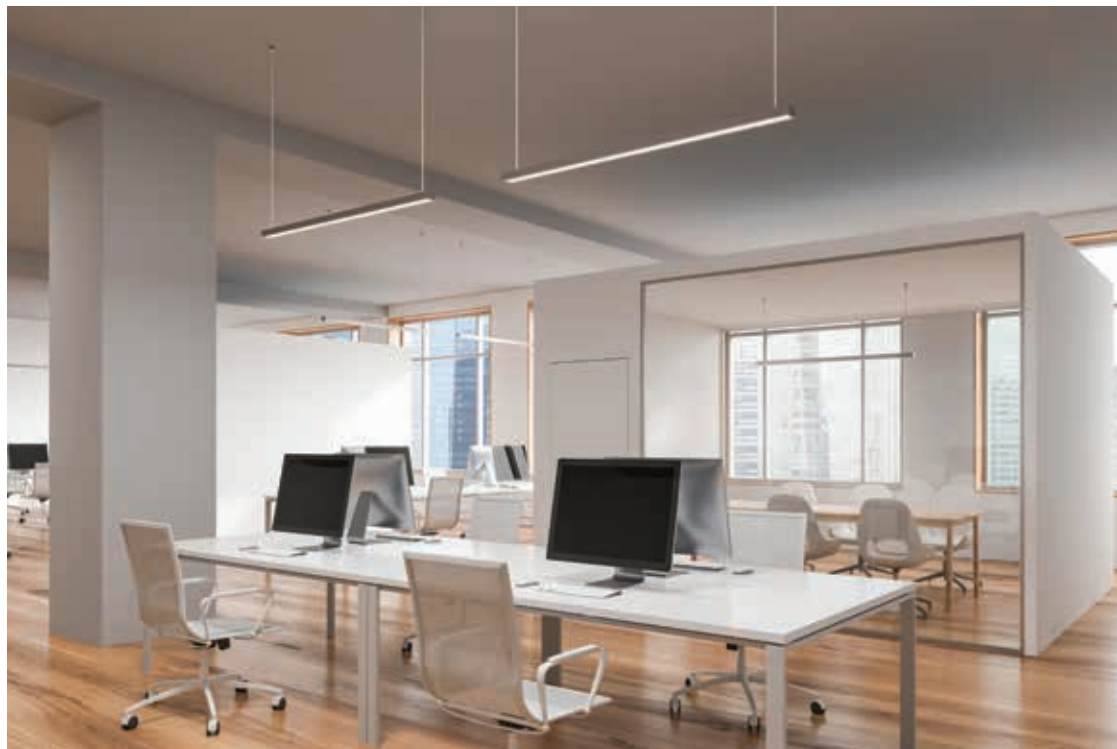

Installazione a soffitto
Ceiling mounting

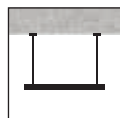

Installazione a sospensione
Suspended installation

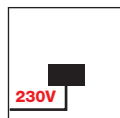

L'apparecchio è fornito completo di alimentatore elettronico 220/240V 50/60Hz ON-OFF posizionato all'interno dell'apparecchio.
The luminaire is supplied with a 220/240V 50/60Hz ON-OFF driver LED.

I KIT di sospensione e i KIT da plafone o parete sono forniti come accessori

The suspension KITS and the ceiling or wall kits are supplied as accessories.



Colori - Colours

- X=2 Bianco
White
- X=3 Nero
Black



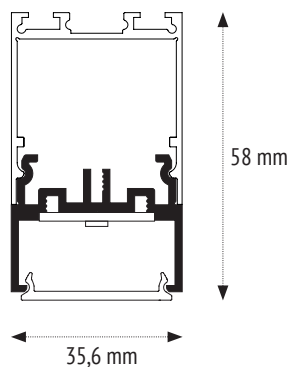

LARA 1120

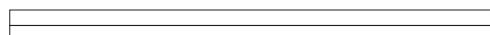

LARA 1680

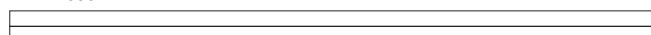

7520 L 1120 mm

Diffusore opale - Opal diffuser

7520.6OPX	LED	CRI80	34W	3640 lm	4000 K	
7520.7OPX	LED	CRI80	34W	3460 lm	3000 K	
7520D.6OPX	LED	CRI80	34W	3640 lm	4000 K	DALI
7520D.7OPX	LED	CRI80	34W	3460 lm	3000 K	DALI

Ottica UGR<19 - UGR<19 optic

7520.6UGRX	LED	CRI80	28W	3510 lm	4000 K	
7520.7UGRX	LED	CRI80	28W	3330 lm	3000 K	
7520D.6UGRX	LED	CRI80	28W	3510 lm	4000 K	DALI
7520D.7UGRX	LED	CRI80	28W	3330 lm	3000 K	DALI

7521 L 1680 mm

Diffusore opale - Opal diffuser

7521.6OPX	LED	CRI80	52W	5460 lm	4000 K	
7521.7OPX	LED	CRI80	52W	5190 lm	3000 K	
7521D.6OPX	LED	CRI80	52W	5460 lm	4000 K	DALI
7521D.7OPX	LED	CRI80	52W	5190 lm	3000 K	DALI

Ottica UGR<19 - UGR<19 optic

7521.6UGRX	LED	CRI80	42W	5270 lm	4000 K	
7521.7UGRX	LED	CRI80	42W	5000 lm	3000 K	
7521D.6UGRX	LED	CRI80	42W	5270 lm	4000 K	DALI
7521D.7UGRX	LED	CRI80	42W	5000 lm	3000 K	DALI

LARA SOSPENSIONE



LARA PLAFONE

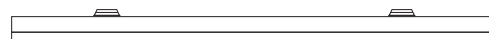

LARA 1120

LARA 1680

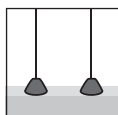

Cod. DS 30
KIT accessori cavi di sospensione
Suspension cable accessories KIT

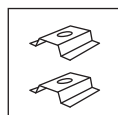

Cod. ST 30
KIT accessori a plafone
Ceiling accessories KIT

LENA

Apparecchio lineare a soffitto per interni costituito da:

- Struttura in alluminio estruso verniciato disponibile in due lunghezze 1120 mm e 1680 mm
- Diffusore in policarbonato opale o ottica UGR<19
- Moduli LED 3000K o 4000K CRI80
- SDCM Mac Adam 3
- Alimentatore integrato in configurazione ON-OFF o dimmerabile DALI
- Staffe di fissaggio a soffitto
- Cavo di alimentazione e dispositivi di sospensione
- Verniciatura in polveri poliesteri ad elevata resistenza ai raggi ultravioletti e alla corrosione

Indoor ceiling linear luminaire constructed of:

- Painted extruded aluminium structure available in two lengths: 1120 mm and 1680 mm
- Opal polycarbonate diffuser or UGR<19 lenses
- LED 3000K or 4000K CRI80 module
- SDCM Mac Adam 3
- ON-OFF or dimmable DALI integrated driver LED
- Ceiling fixing system
- Power cable and suspension fixing accessories
- Painting using high resistance to UV and corrosion polyester powders



Installazione a soffitto
Ceiling mounting

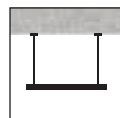

Installazione a sospensione
Suspended installation

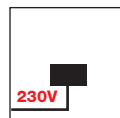

L'apparecchio è fornito completo di alimentatore elettronico 220/240V 50/60Hz ON-OFF posizionato all'interno dell'apparecchio.
The luminaire is supplied with a 220/240V 50/60Hz ON-OFF driver LED.

I KIT di sospensione e i KIT da plafone o parete sono forniti come accessori
The suspension KITS and the ceiling or wall kits are supplied as accessories.



Colori - Colours

- X=2 Bianco
White
- X=3 Nero
Black



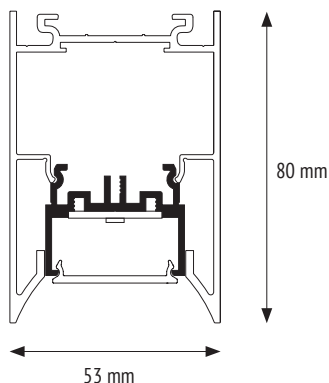

1120



1680



7530 L 1120 mm

Diffusore opale - Opal diffuser

7530.6OPX	LED	CRI80	34W	3640 lm	4000 K	
7530.7OPX	LED	CRI80	34W	3460 lm	3000 K	
7530D.6OPX	LED	CRI80	34W	3640 lm	4000 K	DALI
7530D.7OPX	LED	CRI80	34W	3460 lm	3000 K	DALI

Ottica UGR<19 - UGR<19 optic

7530.6UGRX	LED	CRI80	28W	3510 lm	4000 K	
7530.7UGRX	LED	CRI80	28W	3330 lm	3000 K	
7530D.6UGRX	LED	CRI80	28W	3510 lm	4000 K	DALI
7530D.7UGRX	LED	CRI80	28W	3330 lm	3000 K	DALI

7531 L 1680 mm

Diffusore opale - Opal diffuser

7531.6OPX	LED	CRI80	52W	5460 lm	4000 K	
7531.7OPX	LED	CRI80	52W	5190 lm	3000 K	
7531D.6OPX	LED	CRI80	52W	5460 lm	4000 K	DALI
7531D.7OPX	LED	CRI80	52W	5190 lm	3000 K	DALI

Ottica UGR<19 - UGR<19 optic

7531.6UGRX	LED	CRI80	42W	5270 lm	4000 K	
7531.7UGRX	LED	CRI80	42W	5000 lm	3000 K	
7531D.6UGRX	LED	CRI80	42W	5270 lm	4000 K	DALI
7531D.7UGRX	LED	CRI80	42W	5000 lm	3000 K	DALI

LENA SOSPENSIONE

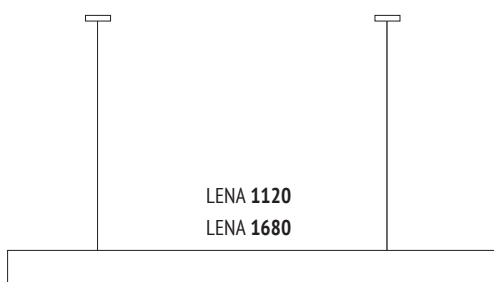

LENA 1120
LENA 1680

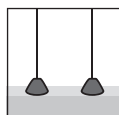

Cod. DS 30
KIT accessori cavi di sospensione
Suspension cable accessories KIT

LENA PLAFONE

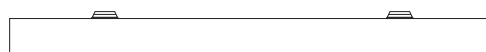

LENA 1120
LENA 1680

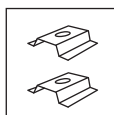

Cod. ST 30
KIT accessori a plafone
Ceiling accessories KIT

MIRA

Apparecchio lineare ad incasso trim a soffitto per interni costituito da:

- Struttura in alluminio estruso verniciato disponibile in due lunghezze 1120 mm e 1680 mm
- Diffusore in policarbonato opale o ottica UGR<19
- Moduli LED 3000K o 4000K CRI80
- Alimentatore remoto elettronico in configurazione ON-OFF o dimmerabile DALI
- Sistema di fissaggio a molle (incluso)
- Verniciatura in polveri poliestere ad elevata resistenza ai raggi ultravioletti e alla corrosione

Indoor recessed linear ceiling trim luminaire constructed of:

- Painted extruded aluminium structure available in two lengths: 1120 mm and 1680 mm
- Opal polycarbonate diffuser or UGR<19 lenses
- LED 3000K or 4000K CRI80 module
- ON-OFF or dimmable DALI integrated remote driver LED
- Spring fixing system (included)
- Painting using high resistance to UV and corrosion polyester powders



Incasso a soffitto
Recessed ceiling version

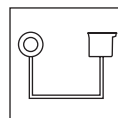

L'apparecchio necessita di alimentatore elettronico remoto (incluso)
The luminaire needs a remote driver LED (included)

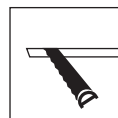

Taglio cartongesso
Plasterboard cutting
MIRA 1120 - 38 mm x 1128 mm
MIRA 1680 - 38 mm x 1688 mm



Colori - Colours

- X=2** Bianco
White
- X=3** Nero
Black

DALI
Su richiesta
On request

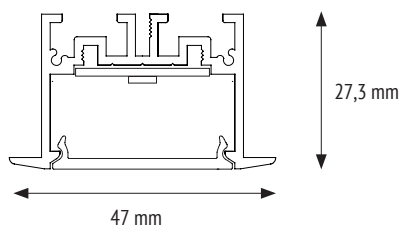

MIRA 1120



MIRA 1680



7550 L 1120 mm

Diffusore opale - Opal diffuser

7550.6OPX	LED	CRI80	24W	2420 lm	4000 K	
7550.7OPX	LED	CRI80	24W	2350 lm	3000 K	
7550D.6OPX	LED	CRI80	24W	2420 lm	4000 K	DALI
7550D.7OPX	LED	CRI80	24W	2350 lm	3000 K	DALI

Ottica UGR<19 - UGR<19 optic

7550.6UGRX	LED	CRI80	20W	3170 lm	4000 K	
7550.7UGRX	LED	CRI80	20W	2900 lm	3000 K	
7550D.6UGRX	LED	CRI80	20W	3170 lm	4000 K	DALI
7550D.7UGRX	LED	CRI80	20W	2900 lm	3000 K	DALI

7551 L 1680 mm

Diffusore opale - Opal diffuser

7551.6OPX	LED	CRI80	34W	3650 lm	4000 K	
7551.7OPX	LED	CRI80	34W	3500 lm	3000 K	
7551D.6OPX	LED	CRI80	34W	3650 lm	4000 K	DALI
7551D.7OPX	LED	CRI80	34W	3500 lm	3000 K	DALI

Ottica UGR<19 - UGR<19 optic

7551.6UGRX	LED	CRI80	30W	4750 lm	4000 K	
7551.7UGRX	LED	CRI80	30W	4490 lm	3000 K	
7551D.6UGRX	LED	CRI80	30W	4750 lm	4000 K	DALI
7551D.7UGRX	LED	CRI80	30W	4490 lm	3000 K	DALI

MIRA SYSTEM

APPARECCHIO PER FILA CONTINUA

Apparecchio lineare ad incasso trim a soffitto per interni costituito da:

- Struttura in alluminio estruso verniciato disponibile in due lunghezze 1120 mm e 1680 mm
- Diffusore in policarbonato opale
- Moduli LED 3000K o 4000K CRI80
- Alimentatore remoto elettronico in configurazione ON-OFF o dimmerabile DALI
- Sistema di fissaggio a molle (incluso)
- Tappo di chiusura escluso
- Verniciatura in polveri poliesteri ad elevata resistenza ai raggi ultravioletti e alla corrosione

LUMINAIRE FOR CONTINUOUS ROW

Indoor recessed linear ceiling trim luminaire constructed of:

- Painted extruded aluminium structure available in two lengths: 1120 mm and 1680 mm
- Polycarbonate opal diffuser
- LED 3000K or 4000K CRI80 module
- ON-OFF or dimmable DALI integrated driver LED
- Spring fixing system (included)
- Closing cap not included
- Painting using high resistance to UV and corrosion polyester powders



Incasso a soffitto
Recessed ceiling version

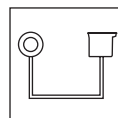

L'apparecchio necessita di alimentatore elettronico remoto (incluso)
The luminaire needs a remote driver LED (included)

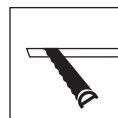

Taglio cartongesso larghezza 38 mm per tutta la lunghezza dell'apparecchio
38 mm drywall cutting for the entire length of the appliance



Colori - Colours

- X=2** Bianco White
- X=3** Nero Black

Per la realizzazione della fila continua la lampada deve essere messa in appoggio una con l'altra senza nessun tipo di accessorio per l'unione delle stesse.

La prima lampada e l'ultima della fila devono essere completate con il tappo di chiusura.

To create the continuous row, the lamp must be placed against each other without any type of accessory for joining them.

First and last lamp in the line must be completed with the closing cap.



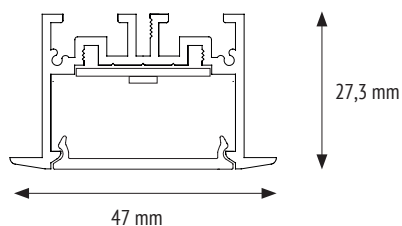

MIRA SYSTEM 1120



MIRA SYSTEM 1680



Apparecchio per fila continua - Luminaire for continuous row

7560 L 1120 mm

Diffusore opale - Opal diffuser

7560.6OPX	LED	CRI80	24W	2420 lm	4000 K
7560.7OPX	LED	CRI80	24W	2350 lm	3000 K

7561 L 1680 mm

Diffusore opale - Opal diffuser

7561.6OPX	LED	CRI80	34W	3650 lm	4000 K
7561.7OPX	LED	CRI80	34W	3500 lm	3000 K

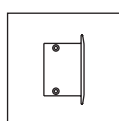

ACCESSORIO
Cod. CH 60
Tappo di chiusura
Closing cap





TILT

TILT

Proiettore snodabile per interni ed esterni costituito da:

- Struttura in alluminio pressofuso verniciato
- Diffusore in vetro trasparente temperato
- Ottiche disponibili 8°, 30°, 72°
- LED COB
- LED MID POWER 2835
- Guarnizioni in silicone
- Viti di chiusura in acciaio inox
- Verniciatura in polveri poliestere ad elevata resistenza ai raggi ultravioletti e alla corrosione

Indoor and outdoor adjustable spotlight constructed of:

- Painted die-cast aluminium structure
- Transparent tempered glass diffuser
- Available optics 8°, 30°, 72°
- LED COB
- LED MID POWER 2835
- Silicon gaskets
- Stainless steel screws
- Painting using high resistance to UV and corrosion polyester powders

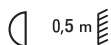

Colori - Colours

X=9  Antracite
Anthracite

X=4  Silver



Cod. 3860 - 3861 - 3880 - 3881
Installazione a parete
Wall mounting



Cod. 3862 - 3882
Installazione su palo
Installation on pole

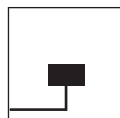

Entrata singola cavi di alimentazione
Single power supply cables input

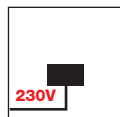

LED
L'apparecchio è fornito completo di alimentatore elettronico 220/240V 50/60Hz posizionato all'interno dell'apparecchio.
The luminaire is supplied with a 220/240V 50/60Hz built-in power supply



Codice-Code CN 22
Connettore sistema di congiunzione IP68 H₂O STOP a 3 poli per cavo Ø 7÷13 mm
IP68 connecting device H₂O STOP with 3 poles for cables Ø 7÷13 mm

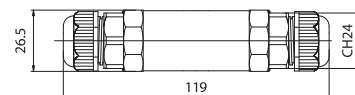

Il proiettore TILT è fornito di un doppio snodo che consente diverse regolazioni sia sul piano orizzontale sia sul piano verticale.

Spotlight TILT is equipped with a double swivel that allows several adjustments both in horizontal and in vertical plane

orientabile ± 45° sul piano orizzontale

swiveling ± 45° on the horizontal plane



3860 LED MID POWER
3880 LED COB

LED MID POWER disponibile in varie ottiche a 8°, 30°, 72°.
LED MID POWER available in various optics 8°, 30°, 72°.

3860.66X	LED	26W	3340 lm	4000 K	8° - 30° - 72°
3860.67X	LED	26W	2830 lm	3000 K	8° - 30° - 72°

3880.20X	LED COB	23W	4100 lm	4000 K	
3880.21X	LED COB	23W	3970 lm	3000 K	

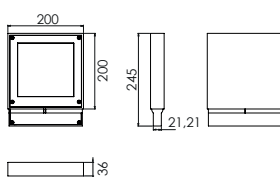

orientabile ± 45° sul piano orizzontale e 350° sul piano verticale

swiveling ± 45° on the horizontal plane and 350° on the vertical plane



3861 LED MID POWER
3881 LED COB

LED MID POWER disponibile in varie ottiche a 8°, 30°, 72°.
LED MID POWER available in various optics 8°, 30°, 72°.

3861.66X	LED	26W	3340 lm	4000 K	8° - 30° - 72°
3861.67X	LED	26W	2830 lm	3000 K	8° - 30° - 72°

3881.20X	LED COB	23W	4100 lm	4000 K	
3881.21X	LED COB	23W	3970 lm	3000 K	

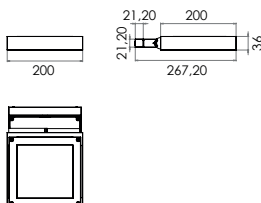

Installazione su palo (palo non fornito)

orientabile ± 45° sul piano orizzontale e 350° sul piano verticale

Possibile installare su palo Ø50 - Ø60 - Ø76 (SPECIFICARE IN FASE D'ORDINE IL DIAMETRO DEL PALO)

Installation on pole (pole not delivered)

swiveling ± 45° on the horizontal plane and 350° on the vertical plane

Possibility of installation on post Ø50 - Ø60 - Ø76 (SPECIFY WHEN ORDERING)



3862 LED MID POWER
3882 LED COB

LED MID POWER disponibile in varie ottiche a 8°, 30°, 72°.
LED MID POWER available in various optics 8°, 30°, 72°.

3862.66X	LED	26W	3340 lm	4000 K	8° - 30° - 72°
3862.67X	LED	26W	2830 lm	3000 K	8° - 30° - 72°

3882.20X	LED COB	23W	4100 lm	4000 K	
3882.21X	LED COB	23W	3970 lm	3000 K	

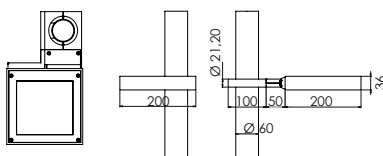





LID WALL



LID



LID WALL

Segnapasso per installazione a parete a luce indiretta. Disponibile in due dimensioni BIG e MINI costituito da:

- Struttura in alluminio pressofuso verniciato
- Diffusore in vetro temperato
- Guarnizioni in silicone
- Viti di chiusura in acciaio inox
- Verniciatura in polveri poliestere ad elevata resistenza ai raggi ultravioletti e alla corrosione

Path marker light wall luminaire. Available in two sizes BIG and MINI constructed of:

- Painted die-cast aluminium structure
- Tempered glass diffuser
- Silicon gaskets
- Stainless steel screws
- Painting using high resistance to UV and corrosion polyester powders



LID WALL STELO

Apparecchio per esterni costituito da:

- Corpo in alluminio pressofuso verniciato
- Palo in acciaio inox AISI 430 verniciato
- Diffusore in vetro satinato

Outdoor post luminaire constructed of:

- Painted die-cast aluminium body
- Painted stainless steel AISI 430 post
- Satin glass diffuser



Colori - Colours

X=9  Antracite / Anthracite

X=4  Silver

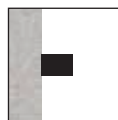

LID WALL
Installazione a parete
Wall mounting

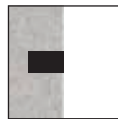

LID 503
Incasso a parete
Recessed wall version

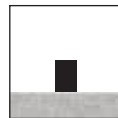

LID WALL STELO
Installazione a terra
Floor mounting

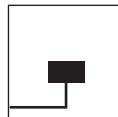

per/for cod. 3873-3876-3878
Entrata singola cavi di alimentazione
Single power supply cables input

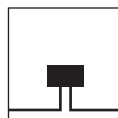

per/for cod. 3870
Doppia entrata cavi di alimentazione
Double power supply cables input

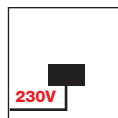

LED
Led a tensione di rete 220/240V 50/60Hz.
Connessione diretta alla rete di alimentazione senza necessità di alimentatore.
LED's direct operation at 220/240V 50/60Hz.
No power supply is required.



IK 10



L'emissione di luce verso il basso è nel pieno rispetto delle leggi contro l'inquinamento luminoso.

The direct light emission is in full compliance with standard light pollution directives



cod. CS 503 per/for cod. 3875
Cassaforma in tecnopolimero per vano ad incasso 104x73 mm - h 50 mm
Technopolymer holder to be recessed into the wall 104x73 mm - h 50 mm

Cod. 3875
Fornito completo di cassaforma
The holder is enclosed



LID WALL

LID WALL



3870 BIG

LID WALL BIG

3870.66X	LED	13W	1510 lm	4000 K
3870.67X	LED	13W	1410 lm	3000 K

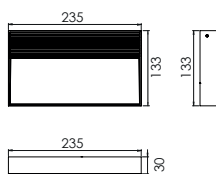

3873 MINI

LID WALL MINI

3873.66X	LED	5W	580 lm	4000 K
3873.67X	LED	5W	540 lm	3000 K

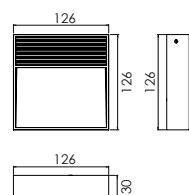

LID 503

LID 503



3875

LID 503

Segnapasso a parete a luce indiretta per scatola normalizzata 503 da murare
Path marker light wall recessed luminaire in normalized plastic box 503

3875.66X	LED	5W	580 lm	4000 K
3875.67X	LED	5W	540 lm	3000 K

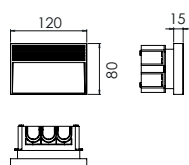

LID WALL STELO

LID WALL STELO



3876 H 500
3878 H 900

3876.66X	LED	5W	580 lm	4000 K
3876.67X	LED	5W	540 lm	3000 K

3878.66X	LED	5W	580 lm	4000 K
3878.67X	LED	5W	540 lm	3000 K

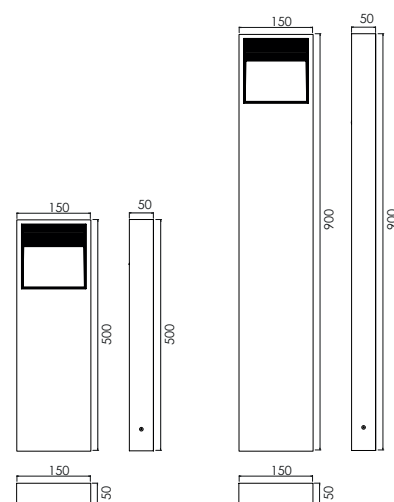

LID

Apparecchio da incasso a parete a luce indiretta costituito da:

- Corpo in alluminio pressofuso verniciato
- Diffusore in vetro temperato
- Parabola riflettente in alluminio
- Guarnizioni in silicone
- Viti di chiusura in acciaio inox
- Cassaforma a muro in tecnopolimero
- Verniciatura in polveri poliesteri ad elevata resistenza ai raggi ultravioletti e alla corrosione

Indirect light recessed wall luminaire constructed of:

- Painted die-cast aluminium body
- Tempered glass diffuser
- Aluminium reflector
- Silicon gaskets
- Stainless steel screws
- Technopolymer wall holder
- Painting using high resistance to UV and corrosion polyester powders

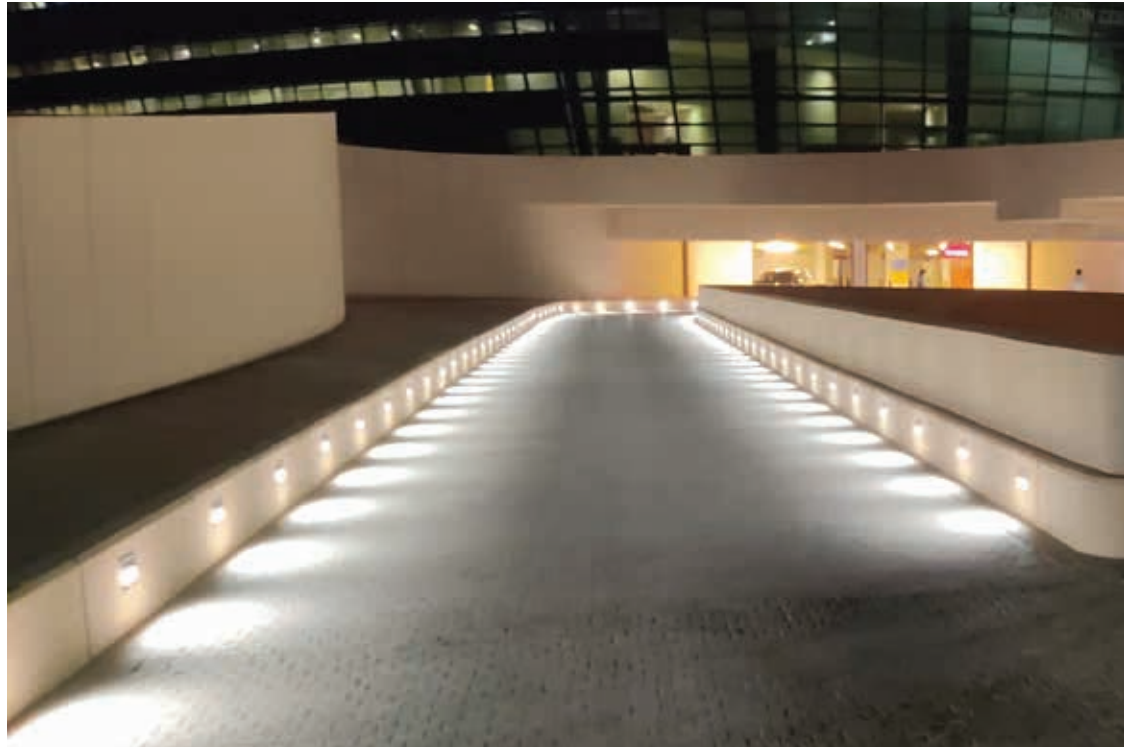

Colori - Colours

X=9  Anthracite

X=4  Silver

Diffusore - Diffuser

Codice-Code 00 3070 - 00 3071
00 3072 - 00 3073
00 3074 - 00 3079

Gli apparecchi vengono forniti completi di cassaforma
The holder is enclosed with the luminaire

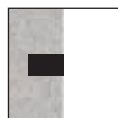

LID
Incasso a parete
Recessed wall version



La cassaforma deve essere installata a filo muro.
Holder must be recessed flush with the wall surface

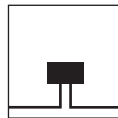

Doppia entrata
cavi di alimentazione
Double power supply cables input

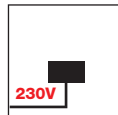

LED
Led a tensione di rete 220/240V 50/60Hz.
Connessione diretta alla rete di alimentazione
senza necessità di alimentatore.
LED's direct operation at 220/240V 50/60Hz.
No power supply is required.



LID



L'emissione di luce verso il basso è nel pieno rispetto delle leggi contro l'inquinamento luminoso.

The direct light emission is in full compliance with standard light pollution directives



cod. CS 30 per/for cod. 3070 - 3071 - 3072
Cassaforma in tecnopolimero per vano ad incasso 143x244 mm - h 112 mm
Technopolymer holder to be recessed into the wall 143x244 mm - h 112 mm



cod. CS 73 per/for cod. 3073
Cassaforma in tecnopolimero per vano ad incasso 132x132 mm - h 61 mm
Technopolymer holder to be recessed into the wall 132x132 mm - h 61 mm



cod. CS 79 per/for cod. 3074 - 3079
Cassaforma in tecnopolimero per vano ad incasso 128x70 mm - h 55 mm
Technopolymer holder to be recessed into the wall 128x70 mm - h 55 mm



3070 - 3074

3070.55X	LED	13W	1790 lm	4000 K
3070.56X	LED	13W	1790 lm	3000 K
3074.66X	LED	4W	380 lm	4000 K
3074.67X	LED	4W	360 lm	3000 K

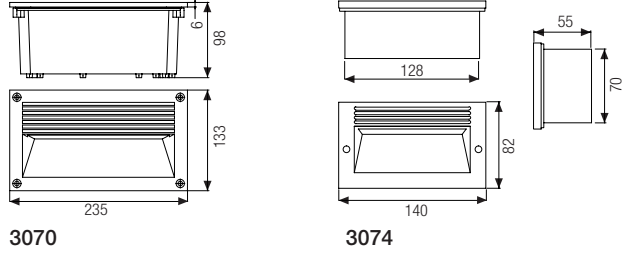

3070

3074

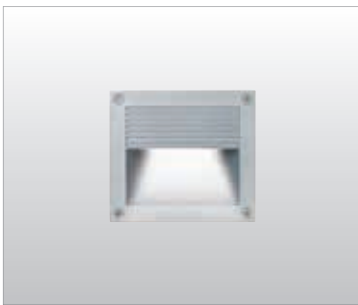

3073

3073.66X	LED	4W	510 lm	4000 K
3073.67X	LED	4W	500 lm	3000 K

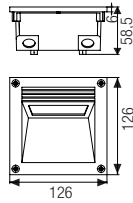

3073



3071 - 3079

3071.66X	LED	8,7W	1120 lm	4000 K
3071.67X	LED	8,7W	1050 lm	3000 K
3079.66X	LED	4W	380 lm	4000 K
3079.67X	LED	4W	360 lm	3000 K

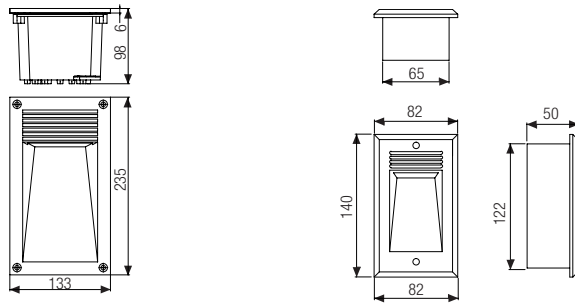

3071

3079

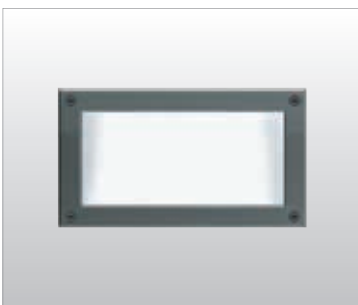

3072

3072.00X	LED	8W	E27	
3072.55X	LED	9W	1240 lm	4000 K
3072.56X	LED	9W	1160 lm	3000 K

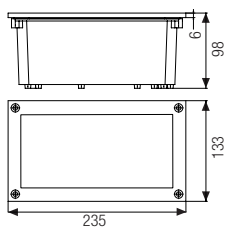

3072

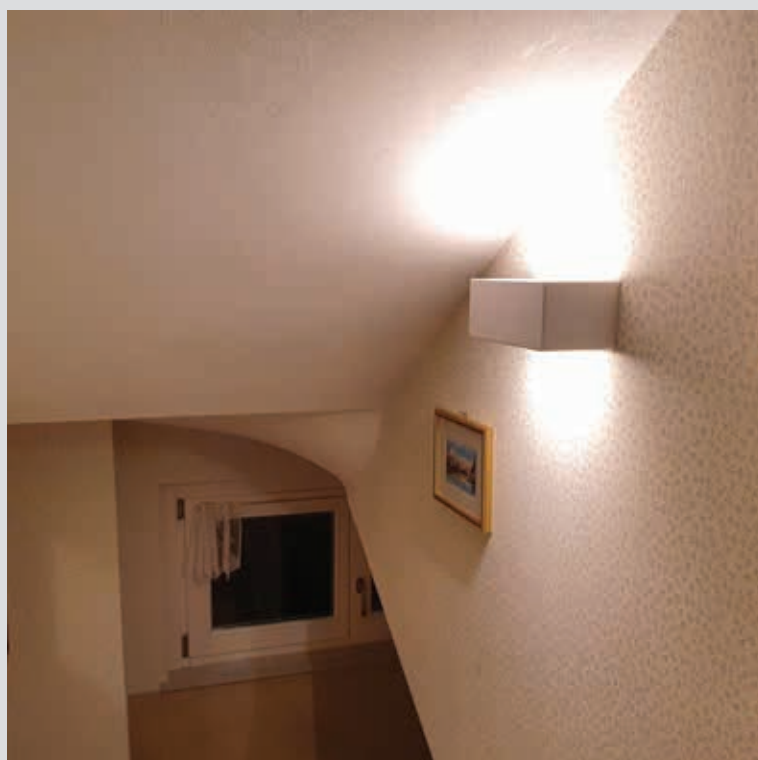



CLARA

CLARA

Apparecchio per illuminazione di esterni e/o di interni costituito da:





- Struttura in alluminio pressofuso verniciato
- Diffusore in vetro temperato o in policarbonato
- Guarnizioni in silicone
- Viti di chiusura in acciaio inox
- Verniciatura in polveri poliestere ad elevata resistenza ai raggi ultravioletti e alla corrosione

Outdoor and/or indoor luminaire constructed of:

- Painted die-cast aluminium structure
- Tempered glass or polycarbonate diffuser
- Silicon gaskets
- Stainless steel screws
- Painting using high resistance to UV and corrosion polyester powders



Colori - Colours

- X=2  Bianco
White
- X=9  Antracite
Anthracite
- X=4  Silver
- X=5  Corten

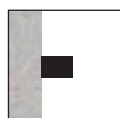

Installazione a parete
Wall mounting

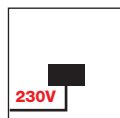

L'apparecchio è fornito completo di alimentatore elettronico 220/240V 50/60Hz posizionato all'interno dell'apparecchio.
The luminaire is supplied with a 220/240V 50/60Hz built-in power supply

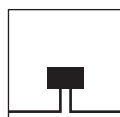

Doppia entrata cavi di alimentazione
Double power supply cables input

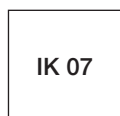

IK 07



4321

Monodirezionale - Mono direction light

4321.66X	LED	15W	2500 lm	4000 K
4321.67X	LED	15W	2500 lm	3000 K

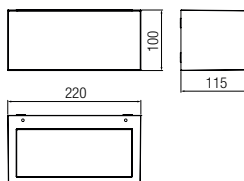

4322

Bidirezionale - Double direction light

4322.66X	LED	2x12W	2x1930 lm	4000 K
4322.67X	LED	2x12W	2x1930 lm	3000 K

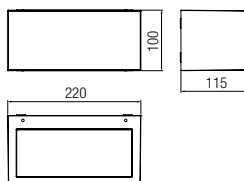





DORA



OLIVIA

DORA/OLIVIA

Apparecchio per illuminazione di esterni e/o di interni costituito da:





- Struttura in alluminio pressofuso verniciato
- Diffusore in vetro temperato
- Parabola riflettente in alluminio
- Guarnizioni in silicone
- Viti di chiusura in acciaio inox
- Verniciatura in polveri poliestere ad elevata resistenza ai raggi ultravioletti e alla corrosione

Outdoor and/or indoor luminaire constructed of:

- Painted die-cast aluminium structure
- Tempered glass diffuser
- Aluminium reflector
- Silicon gaskets
- Stainless steel screws
- Painting using high resistance to UV and corrosion polyester powders



Colori - Colours

- X=2  Bianco
White
- X=9  Antracite
Anthracite
- X=4  Silver
- X=5  Corten

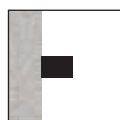

Installazione a parete
Wall mounting

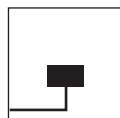

Entrata singola cavi di alimentazione
Single power supply cables input

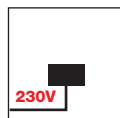

LED
L'apparecchio è fornito completo di alimentatore elettronico 220/240V 50/60Hz posizionato all'interno dell'apparecchio.
The luminaire is supplied with a 220/240V 50/60Hz built-in power supply



DORA

IK 07



OLIVIA

IK 06





3820

Monodirezionale - Mono direction light

3820.66X	LED	15W	2100 lm	4000 K
3820.67X	LED	15W	2000 lm	3000 K

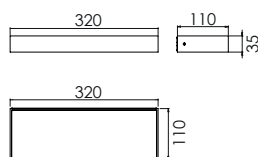

3822

Bidirezionale - Double direction light

3822.66X	LED	15W	2100 lm	4000 K
3822.67X	LED	15W	2000 lm	3000 K

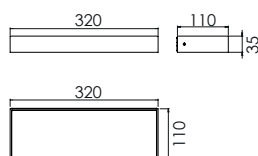

3830

Monodirezionale - Mono direction light

3830.66X	LED	15W	2100 lm	4000 K
3830.67X	LED	15W	2000 lm	3000 K

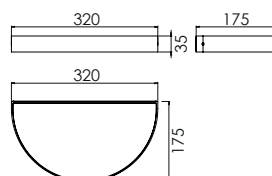

3832

Bidirezionale - Double direction light

3832.66X	LED	15W	2100 lm	4000 K
3832.67X	LED	15W	2000 lm	3000 K

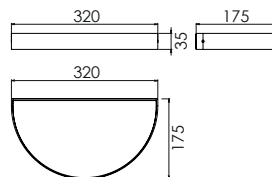





LINE

LINE

Apparecchio per esterni a parete.

Disponibile in 3 dimensioni:

LINE 510

LINE 320

LINE 210

È costituito da:

- Corpo in alluminio pressofuso verniciato
- Diffusore in vetro satinato
- Parabola riflettente in alluminio
- Guarnizioni in silicone
- Viti di chiusura in acciaio inox
- Verniciatura in polveri poliestere ad elevata resistenza ai raggi ultravioletti e alla corrosione

PER BLUE LINE

- Linea luminosa in policarbonato blu

Outdoor wall luminaire available in 3 different sizes:

LINE 510

LINE 320

LINE 210

It is constructed of:

- Painted die-cast aluminium body
- Satin glass diffuser
- Aluminium reflector
- Silicon gaskets
- Stainless steel screws
- Painting using high resistance to UV and corrosion polyester powders

FOR BLUE LINE

- Blue lighted polycarbonate stripe



Line colori - Line colours

X=9  Anthracite
Anthracite

X=4  Silver

Diffusore - Diffuser

Codice-Code 00 6061
00 6063
00 6065

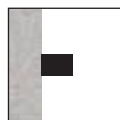

Installazione a parete
Wall mounting

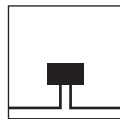

Doppia entrata cavi di alimentazione
Double power supply cables input

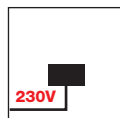

LED

L'apparecchio è fornito completo di alimentatore elettronico 220/240V 50/60Hz posizionato all'interno dell'apparecchio.
The luminaire is supplied with a 220/240V 50/60Hz built-in power supply.



IK 07



L'apparecchio LINE 510 può essere installato sia orizzontale sia verticale

LINE 510 luminaire can be installed both horizontal and vertical

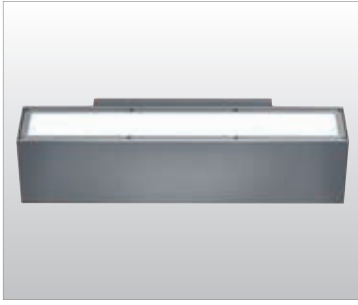

6061 - 6062 LINE 510

Monodirezionale - Mono direction light

6061.66X	LED	16W	2800 lm	4000 K
6061.67X	LED	16W	2700 lm	3000 K

Bidirezionale - Double direction light

6062.66X	LED	22W	2x2100 lm	4000 K
6062.67X	LED	22W	2x2000 lm	3000 K

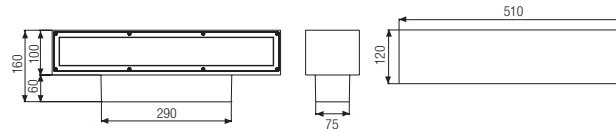

6063 - 6064 LINE 320

Monodirezionale - Mono direction light

6063.66X	LED	13W	1700 lm	4000 K
6063.67X	LED	13W	1700 lm	3000 K

Bidirezionale - Double direction light

6064.66X	LED	2x13W	2x1700 lm	4000 K
6064.67X	LED	2x13W	2x1700 lm	3000 K

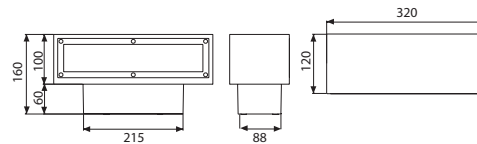

6065 - 6066 LINE 210

Monodirezionale - Mono direction light

6065.66X	LED	10W	1400 lm	4000 K
6065.67X	LED	10W	1400 lm	3000 K

Bidirezionale - Double direction light

6066.66X	LED	2x10W	2x1400 lm	4000 K
6066.67X	LED	2x10W	2x1400 lm	3000 K

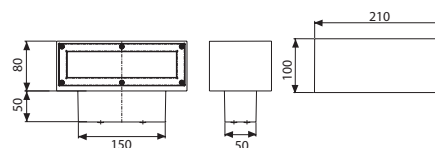



TECNICA RAZIONALE E NOTE DI COLORE

Nella Blue Line una linea retta attraversa tutta la lampada con un effetto di luce elegante e raffinato.

RATIONAL TECHNIQUE AND EMOTIONAL NOTES OF COLOR

In the Blue Line a straight line crosses the body of the luminaire giving to it a fine and elegant light effect.

BLUE LINE

BLUE LINE

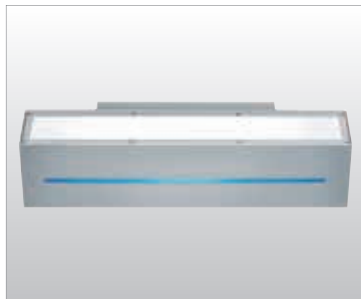

6071 - 6072 BLUE LINE 510

Monodirezionale - Mono direction light

6071.66X	LED	16W	2500 lm	4000 K
6071.67X	LED	16W	2400 lm	3000 K

Bidirezionale - Double direction light

6072.66X	LED	22W	2x2100 lm	4000 K
6072.67X	LED	22W	2x1900 lm	3000 K

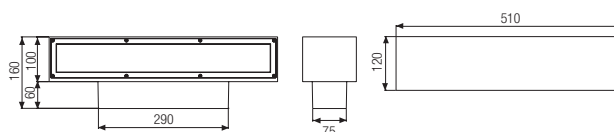

6075 - 6076 BLUE LINE 210

Monodirezionale - Mono direction light

6075.66X	LED	10W	1200 lm	4000 K
6075.67X	LED	10W	1200 lm	3000 K

Bidirezionale - Double direction light

6076.66X	LED	20W	1200 lm	4000 K
6076.67X	LED	20W	1200 lm	3000 K

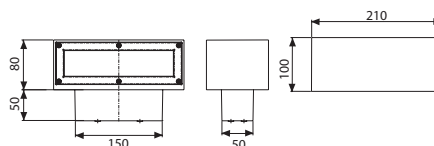





MAYA



GAIA



ZERO



LIA

MAYA/ZERO

Apparecchio per illuminazione di esterni e/o di interni costituito da:

- Struttura in alluminio pressofuso verniciato
- Diffusore in policarbonato
- Guarnizione in silicone
- Viti di chiusura in acciaio inox
- Verniciatura in polveri poliestere ad elevata resistenza ai raggi ultravioletti e alla corrosione

Outdoor and/or indoor luminaire constructed of:

- Painted die-cast aluminium structure
- Polycarbonate diffuser
- Silicon gasket
- Stainless steel screws
- Painting using high resistance to UV and corrosion polyester powders



Colori - Colours

X=9  Antracite
Anthracite

X=4  Silver

Diffusore - Diffuser

Codice-Code 08 4024
per/for MAYA

Codice-Code 08 3024
per/for ZERO

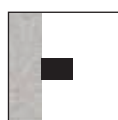

Installazione a parete
Wall mounting



Installazione a soffitto
Ceiling mounting



Entrata singola cavi di alimentazione
Single power supply cables input

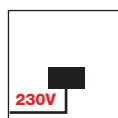

LED
Led a tensione di rete 220/240V 50/60Hz.
Connessione diretta alla rete di alimentazione
senza necessità di alimentatore.
LED's direct operation at 220/240V 50/60Hz.
No power supply is required.



IK 06





4024

4024.25X	LED	19,5W	2510 lm	4000 K
4024.26X	LED	19,5W	2350 lm	3000 K

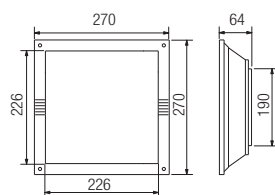

4025

4025.25X	LED	19,5W	2510 lm	4000 K
4025.26X	LED	19,5W	2350 lm	3000 K

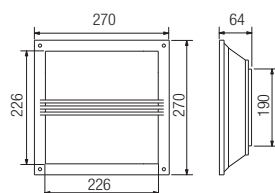

3024

3024.45X	LED	19,5W	2510 lm	4000 K
3024.46X	LED	19,5W	2350 lm	3000 K

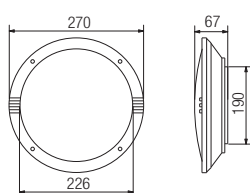

3025

3025.45X	LED	19,5W	2510 lm	4000 K
3025.46X	LED	19,5W	2350 lm	3000 K

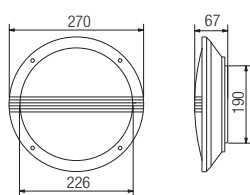

GAIA/LIA

Apparecchio per illuminazione di esterni e/o di interni costituito da:

- Struttura in alluminio pressofuso verniciato
- Diffusore in vetro per GAIA
- Diffusore in vetro o in policarbonato per LIA
- Guarnizioni in silicone
- Viti di chiusura in acciaio inox
- Verniciatura in polveri poliesteri ad elevata resistenza ai raggi ultravioletti e alla corrosione

Outdoor and/or indoor luminaire constructed of:

- Painted die-cast aluminium structure
- Glass diffuser for GAIA
- Glass or polycarbonate diffuser for LIA
- Silicon gaskets
- Stainless steel screws
- Painting using high resistance to UV and corrosion polyester powders

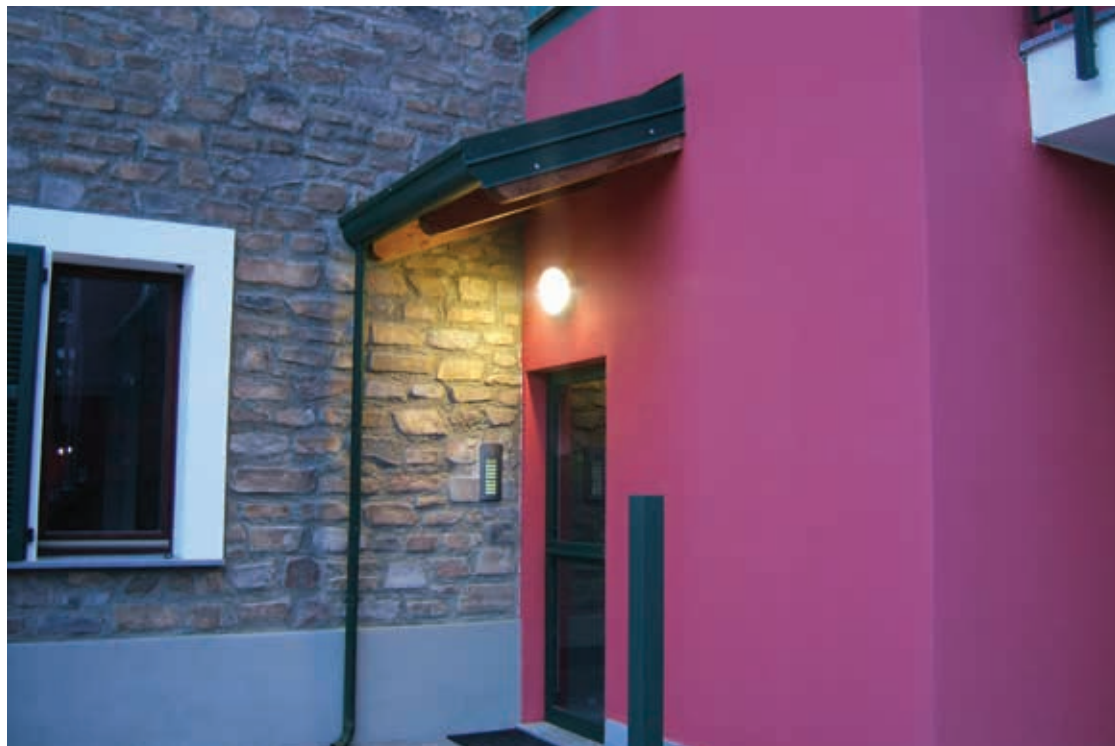

Colori - Colours

X=9  Antracite
Anthracite

X=4  Silver

Diffusore - Diffuser

Per for GAIA

Codice-Code 00 1300
vetro / glass

Per for LIA

Codice-Code 00 1000
vetro / glass

Codice-Code 08 1000
policarbonato / polycarbonate

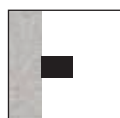

Installazione a parete
Wall mounting



Installazione a soffitto
Ceiling mounting

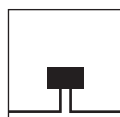

Doppia entrata cavi di alimentazione
Double power supply cables input

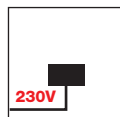

LED GAIA
Led a tensione di rete 220/240V 50/60Hz.
Connessione diretta alla rete di alimentazione
senza necessità di alimentatore.
LED's direct operation at 230/240V 50/60Hz.
No power supply is required.

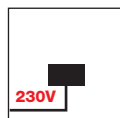

LED LIA
L'apparecchio è fornito completo di
alimentatore elettronico 220/240V 50/60Hz
posizionato all'interno dell'apparecchio.
The luminaire is supplied with a 220/240V 50/60Hz
built-in power supply

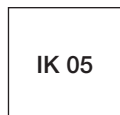

IK 05





1310

1310.66X	LED	12,9W	1500 lm	4000 K
1310.67X	LED	12,9W	1500 lm	3000 K

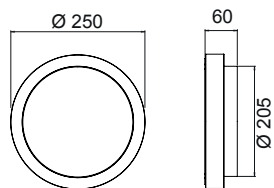

3026

3026.66X	LED	17W	2500 lm	4000 K
3026.67X	LED	17W	2500 lm	3000 K

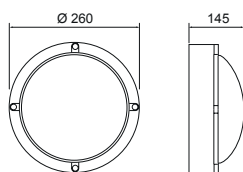

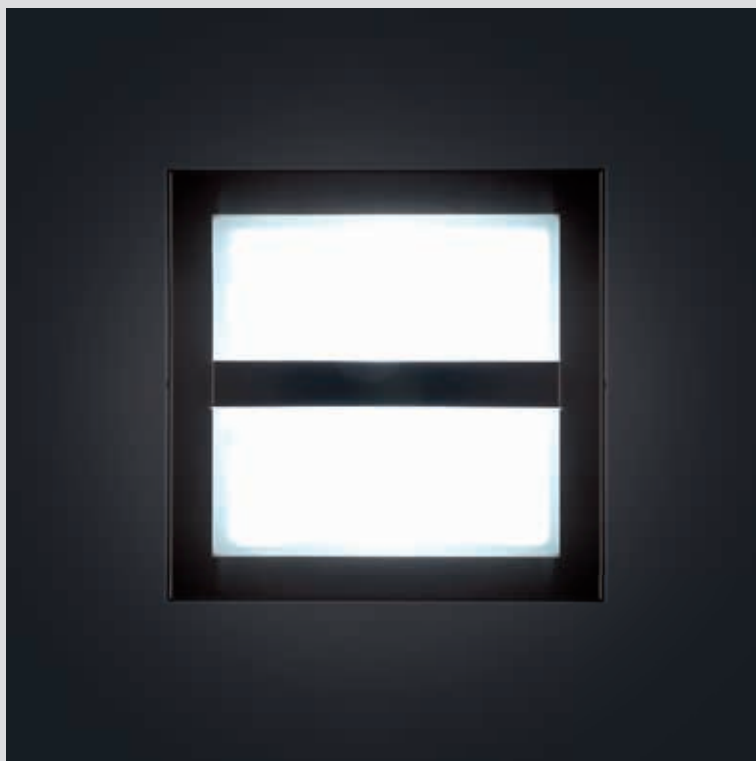



PACK



PACK

Apparecchio per illuminazione di esterni e/o di interni costituito da:

- Corpo in alluminio pressofuso verniciato
- Copertura in acciaio inox AISI 316L per Cod. 1400
- Copertura in alluminio pressofuso verniciato per Cod. 1405-1408-1305-1308
- Diffusore in vetro
- Guarnizioni in silicone
- Viti di chiusura in acciaio inox
- Verniciatura in polveri poliestere ad elevata resistenza ai raggi ultravioletti e alla corrosione

Outdoor and/or indoor luminaire constructed of:

- Painted die-cast aluminium body
- Stainless steel AISI 316L cover for Cod. 1400
- Die-cast painted aluminium cover for Cod. 1405-1408-1305-1308
- Glass diffuser
- Silicon gaskets
- Stainless steel screws
- Painting using high resistance to UV and corrosion polyester powders



Colori - Colours

X=9  Antracite
Anthracite

X=4  Silver

Diffusore - Diffuser

Codice-Code 00 1400

Codice-Code 00 1300

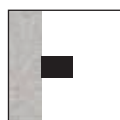

Installazione a parete
Wall mounting



Installazione a soffitto
Ceiling mounting

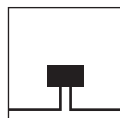

Doppia entrata cavi di alimentazione
Double power supply cables input

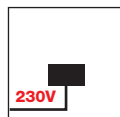

LED
Led a tensione di rete 220/240V 50/60Hz.
Connessione diretta alla rete di alimentazione
senza necessità di alimentatore.
LED's direct operation at 220/240V 50/60Hz.
No power supply is required.

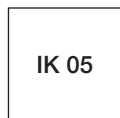

IK 05





1400 - 1405

Copertura in acciaio inox AISI 316L

Stainless steel AISI 316L cover

1400.250	LED	12,9W	1500lm	4000 K
1400.260	LED	12,9W	1500lm	3000 K

Copertura in alluminio pressofuso

Die-cast aluminium cover

1405.25X	LED	12,9W	1500lm	4000 K
1405.26X	LED	12,9W	1500lm	3000 K

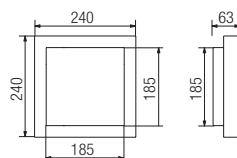

1408

Copertura in alluminio pressofuso

Die-cast aluminium cover

1408.25X	LED	12,9W	1500lm	4000 K
1408.26X	LED	12,9W	1500lm	3000 K

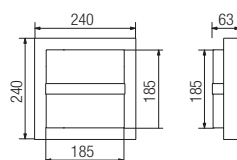

1305

Copertura in alluminio pressofuso

Die-cast aluminium cover

1305.45X	LED	12,9W	1500 lm	4000 K
1305.46X	LED	12,9W	1500 lm	3000 K

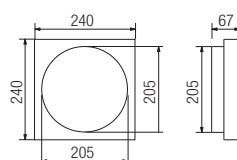

1308

Copertura in alluminio pressofuso

Die-cast aluminium cover

1308.45X	LED	12,9W	1500 lm	4000 K
1308.46X	LED	12,9W	1500 lm	3000 K

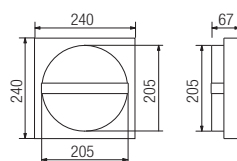





SLASH

SLASH STELO



SLASH

Apparecchio per illuminazione di esterni applicabile a parete disponibile in due dimensioni BIG e MINI costituito da:

- Corpo in alluminio pressofuso verniciato
- Diffusore in vetro temperato
- Parabola riflettente in alluminio
- Guarnizioni in silicone
- Viti di chiusura in acciaio inox
- Verniciatura in polveri poliestere ad elevata resistenza ai raggi ultravioletti e alla corrosione

Outdoor wall luminaire available in two sizes BIG and MINI constructed of:

- Painted die-cast aluminium body
- Tempered glass diffuser
- Aluminium reflector
- Silicon gaskets
- Stainless steel screws
- Painting using high resistance to UV and corrosion polyester powders



SLASH STELO

Apparecchio per esterni costituito da:

- Palo in alluminio estruso verniciato
- Corpo superiore in alluminio pressofuso verniciato

Outdoor post luminaire constructed of:

- Painted extruded aluminium post
- Painted die-cast aluminium head



Colori - Colours

X=9  Anthracite
Anthracite

X=4  Silver

Le lampadine vengono fornite solo su richiesta

Bulbs supplied only on request

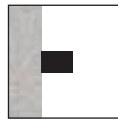

SLASH
Installazione a parete
Wall mounting

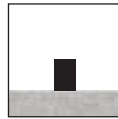

SLASH STELO
Installazione a terra
Floor mounting

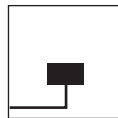

Entrata singola cavi di alimentazione
Single power supply cables input

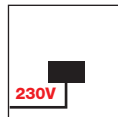

LED
Led a tensione di rete 220/240V 50/60Hz.
Connessione diretta alla rete di alimentazione senza necessità di alimentatore.
LED's direct operation at 220/240V 50/60Hz.
No power supply is required.

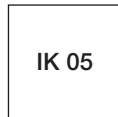

IK 05



6024 MINI

6024.66X	LED	4W	510 lm	4000 K
6024.67X	LED	4W	500 lm	3000 K

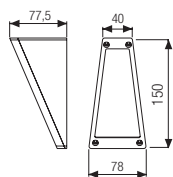

6020 BIG

6020.95X	 TC-DEL	26W	G24 q-3	
Con reattore elettronico / With electronic ballast				
6020.55X	LED	13W	1790 lm	4000 K
6020.56X	LED	13W	1790 lm	3000 K

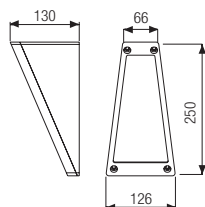

6021 BIG

6021.95X	 TC-DEL	26W	G24 q-3	
Con reattore elettronico / With electronic ballast				
6021.55X	LED	13W	1790 lm	4000 K
6021.56X	LED	13W	1790 lm	3000 K

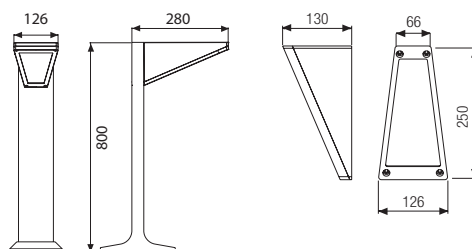

SLASH STELO





BELT BIG



BELT MINI

BELT

Apparecchio da esterni e da interni a parete. Disponibile in 2 dimensioni. Costituito da:

- Corpo in alluminio pressofuso verniciato
- Diffusore in policarbonato
- Parabola riflettente in alluminio
- Guarnizioni in silicone
- Viti di chiusura in acciaio inox
- Verniciatura in polveri poliesteri ad elevata resistenza ai raggi ultravioletti e alla corrosione

Wall outdoor or indoor luminaire. It is available in 2 different sizes. Constructed of:

- Painted die-cast aluminium body
- Polycarbonate diffuser
- Aluminium reflector
- Silicon gaskets
- Stainless steel screws
- Painting using high resistance to UV and corrosion polyester powders



Colori - Colours

- X=2 Bianco
White
- X=9 Antracite
Anthracite
- X=4 Silver

Diffusore - Diffuser
Codice-Code 08 4040
Codice-Code 08 6060



Installazione a parete
Wall mounting

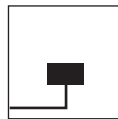

Entrata singola cavi di alimentazione
Single power supply cables input

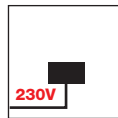

LED - Cod. 4040
L'apparecchio è fornito completo di alimentatore elettronico 220/240V 50/60Hz posizionato all'interno dell'apparecchio.
The luminaire is supplied with a 220/240V 50/60Hz built-in power supply.

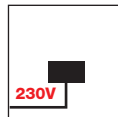

LED - Cod. 6060
Led a tensione di rete 220/240V 50/60Hz.
Connessione diretta alla rete di alimentazione senza necessità di alimentatore.
LED's direct operation at 220/240V 50/60Hz.
No power supply is required.



IK 09



L'apparecchio BELT può essere installato sia orizzontale sia verticale

BELT can be installed both horizontal and vertical



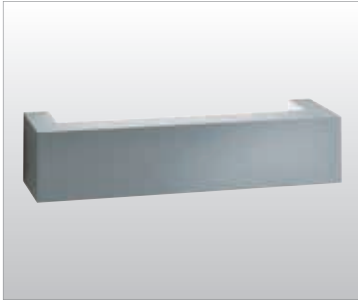

4040

BELT BIG

4040.66X	LED	17W	2200 lm	4000 K
4040.67X	LED	17W	2200 lm	3000 K

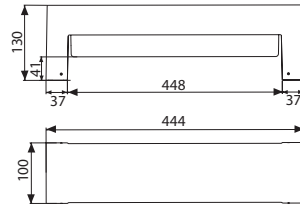

6060

BELT MINI

6060.55X	LED	9W	1240 lm	4000 K
6060.56X	LED	9W	1160 lm	3000 K

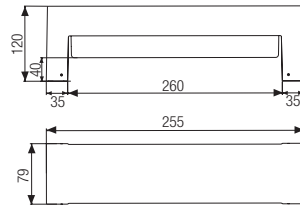





SHARP



SHARP

Apparecchio da esterni per installazione a parete o a terra, disponibili con luci bidirezionali o monodirezionali costituito da:

- Corpo in alluminio pressofuso verniciato
- Diffusore in vetro satinato
- Parabola riflettente in alluminio
- Guarnizioni in silicone
- Viti di chiusura in acciaio inox
- Verniciatura in polveri poliestere ad elevata resistenza ai raggi ultravioletti e alla corrosione

Wall or ground outdoor luminaire, available with mono-direction or double-direction light constructed of:

- Painted die-cast aluminium body
- Satin glass diffuser
- Aluminium reflector
- Silicon gaskets
- Stainless steel screws
- Painting using high resistance to UV and corrosion polyester powders



Colori - Colours

X=9  Antracite
Anthracite

X=4  Silver

Diffusore - Diffuser

Codice-Code 00 7021

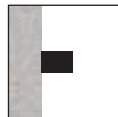

7021 - 7022
Installazione a parete
Wall mounting

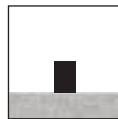

7024 - 7025
Installazione a terra
Floor mounting

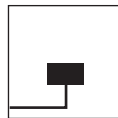

Entrata singola cavi di alimentazione
Single power supply cables input

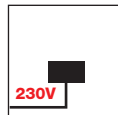

LED
Led a tensione di rete 220/240V 50/60Hz.
Connessione diretta alla rete di alimentazione senza necessità di alimentatore.
LED's direct operation at 220/240V 50/60Hz.
No power supply is required.



IK 07



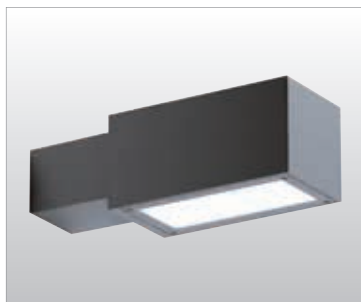

7021 - 7022

Installazione a parete

Wall mounting



Monodirezionale
Mono-directional

7021.66X	LED	13W	1790 lm	4000 K
7021.67X	LED	13W	1790 lm	3000 K



Bidirezionale
Double-directional

7022.66X	LED	2X9W	2X1240 lm	4000 K
7022.67X	LED	2X9W	2X1160 lm	3000 K

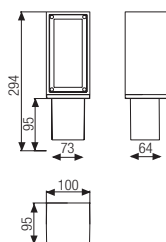

7024 - 7025

Installazione a terra

Floor mounting



Monodirezionale
Mono-directional

7025.66X	LED	13W	1790 lm	4000 K
7025.67X	LED	13W	1790 lm	3000 K



Bidirezionale
Double-directional

7024.66X	LED	2X9W	2X1240 lm	4000 K
7024.67X	LED	2X9W	2X1160 lm	3000 K

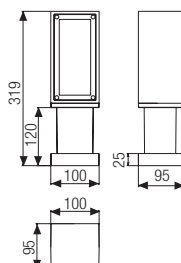

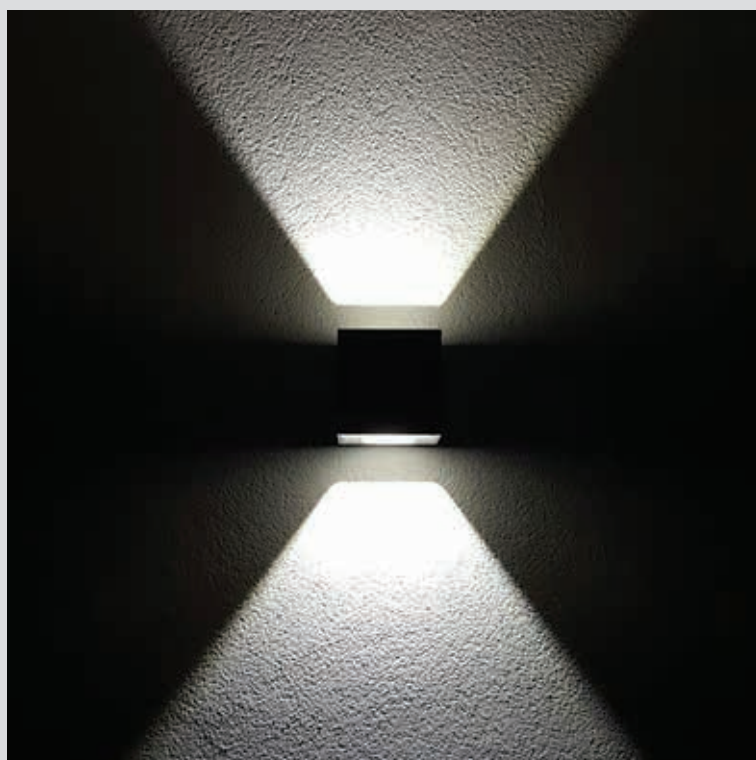

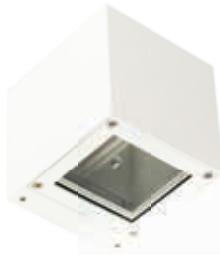

DM 3
DM 3 STELO



DM 4
DM 4 STELO



DIXIE
DIXIE STELO

DM 3

Apparecchio da parete per illuminazione di interni e di esterni ad emissione di luce con varie aperture di fasci luminosi costituito da:

- Struttura in alluminio pressofuso verniciato
- Vetri piani temperati e/o lenti
- Parabola riflettente in alluminio
- Guarnizioni in silicone
- Viti di chiusura in acciaio inox
- Verniciatura in polveri poliestere ad elevata resistenza ai raggi ultravioletti e alla corrosione

Wall outdoor and indoor luminaire with various light beams constructed of:

- Painted die-cast aluminium structure
- Tempered glasses or/and lenses
- Aluminium reflector
- Silicon gaskets
- Stainless steel screws
- Painting using high resistance to UV and corrosion polyester powders



DM 3 STELO

Apparecchio per esterni costituito da:

- Palo in alluminio estruso verniciato
- Corpo superiore in alluminio pressofuso verniciato

Outdoor luminaire constructed of:

- Painted extruded aluminium post
- Painted die-cast aluminium head



Colori - Colours

- X=2 Bianco
White
- X=3 Nero
Black
- X=9 Antracite
Anthracite
- X=4 Silver

Diffusore - Diffuser

Codice-Code 00 4031
vetro / glass

Codice-Code 04 4033
lente rettangolare / rectangular lens

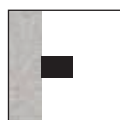

DM 3
Installazione a parete
Wall mounting

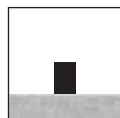

DM 3 STELO
Installazione a terra
Floor mounting

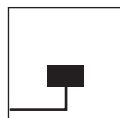

Entrata singola cavi di alimentazione
Single power supply cables input

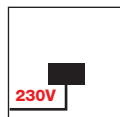

LED
Led a tensione di rete 220/240V 50/60Hz.
Connessione diretta alla rete di alimentazione
senza necessità di alimentatore.
LED's direct operation at 220/240V 50/60Hz.
No power supply is required.



Lampadina LED GU10 IP20 dimmerabile
LED GU10 IP20 dimmable bulb

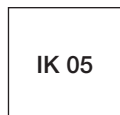

IK 05

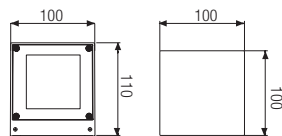
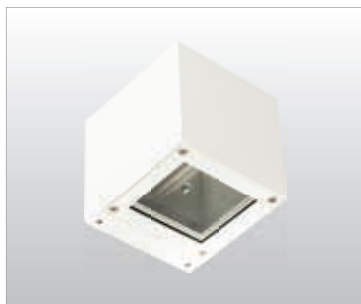

DM 3 su richiesta è disponibile anche con fascio luminoso 40°.

DM 3 available also with 40° light beam on request.



4031

Monodirezionale con un vetro - Fascio luminoso $\pm 70^\circ$

Mono direction light with one glass - $\pm 70^\circ$ light beam

4031.66X	LED	4W	510 lm	4000 K
4031.67X	LED	4W	500 lm	3000 K
• 4031.05X	LED GU10	4,9W	560 lm	4000 K
• 4031.06X	LED GU10	4,9W	560 lm	3000 K



4032

Bidirezionale con due vetri - Fasci luminosi $\pm 70^\circ$

Double direction light with two glasses - $\pm 70^\circ$ light beams

4032.66X	LED	2x4W	2x510 lm	4000 K
4032.67X	LED	2x4W	2x500 lm	3000 K



4033

Bidirezionale con una lente $\pm 10^\circ$ e un vetro fascio luminoso $\pm 70^\circ$

Double direction light with 1 lens $\pm 10^\circ$ and 1 glass $\pm 70^\circ$ light beam

4033.66X	LED	2x4W	2x510 lm	4000 K
4033.67X	LED	2x4W	2x500 lm	3000 K

- L'apparecchio viene fornito completo di lampadina

Bulb enclosed with the luminaire



4036 H 500

4038 H 800

Bidirezionale con due fasci luminosi

Double direction light with two light beams

4036.55X	LED	2x4W	2x510 lm	4000 K
4036.56X	LED	2x4W	2x500 lm	3000 K

4038.55X	LED	2x4W	2x510 lm	4000 K
4038.56X	LED	2x4W	2x500 lm	3000 K

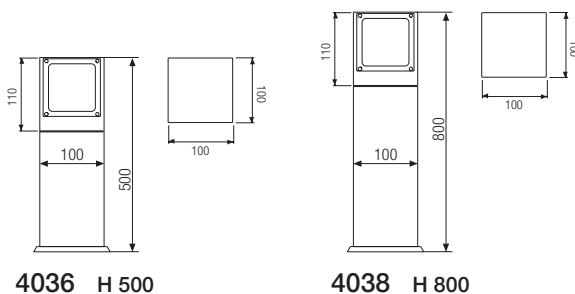

4036 H 500

4038 H 800

DM 3 STELO

DM 4

Apparecchio da parete per illuminazione di interni e di esterni ad emissione di luce con varie aperture di fasci luminosi costituito da:

- Struttura in alluminio pressofuso verniciato
- Vetri piani temperati e/o lenti
- Parabola riflettente in alluminio
- Guarnizioni in silicone
- Viti di chiusura in acciaio inox
- Verniciatura in polveri poliestere ad elevata resistenza ai raggi ultravioletti e alla corrosione

Wall outdoor and indoor luminaire with various light beams constructed of:

- Painted die-cast aluminium structure
- Tempered glasses or/and lenses
- Aluminium reflector
- Silicon gaskets
- Stainless steel screws
- Painting using high resistance to UV and corrosion polyester powders



Colori - Colours

- X=2 Bianco
White
- X=9 Antracite
Anthracite
- X=4 Silver

Diffusore - Diffuser

Codice-Code 00 3031
00 3034

Codice-Code 04 3033
lente rettangolare / rectangular lens

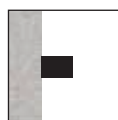

Installazione a parete
Wall mounting



Per / For cod. 3034
ACCESSORIO: cod. PT74
Questo accessorio serve per chiudere una o più uscite di luce secondo le esigenze di installazione

This part is used to close one or more light openings as for the installation's necessities

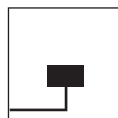

Entrata singola cavi di alimentazione
Single power supply cables input

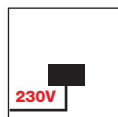

LED - Cod. 3031 - 3032 - 3033
Led a tensione di rete 220/240V 50/60Hz.
Connessione diretta alla rete di alimentazione senza necessità di alimentatore.
LED's direct operation at 220/240V 50/60Hz.
No power supply is required.

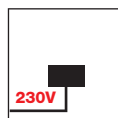

LED - Cod. 3034
L'apparecchio è fornito completo di alimentatore elettronico 220/240V 50/60Hz posizionato all'interno dell'apparecchio.
The luminaire is supplied with a 220/240V 50/60Hz built-in power supply.

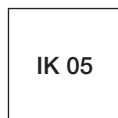

IK 05



Installazione a parete
Wall mounting

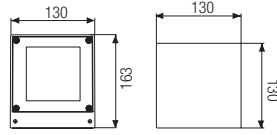

DM 4 su richiesta è disponibile anche con fascio luminoso 40°.
DM 4 available also with 40° light beam on request.



3031

Monodirezionale con un vetro - Fascio luminoso $\pm 70^\circ$
Mono direction light with one glass - $\pm 70^\circ$ light beam

3031.66X	LED	8W	1400 lm	4000 K
3031.67X	LED	8W	1400 lm	3000 K



3032

Bidirezionale con due vetri - Fasci luminosi $\pm 70^\circ$
Double direction light with two glasses - $\pm 70^\circ$ light beams

3032.66X	LED	2x8W	2x1400 lm	4000 K
3032.67X	LED	2x8W	2x1400 lm	3000 K



3033

Bidirezionale con una lente $\pm 10^\circ$ e un vetro fascio luminoso $\pm 70^\circ$
Double direction light with 1 lens $\pm 10^\circ$ and 1 glass $\pm 70^\circ$ light beam

3033.66X	LED	2x8W	2x1400 lm	4000 K
3033.67X	LED	2x8W	2x1400 lm	3000 K



3034

4 fasci luminosi
4 light beams

3034.00X	LED	10W	E27	
3034.55X	LED	17,6W	2270 lm	4000 K
3034.56X	LED	17,6W	2125 lm	3000 K

DM 4 STELO

Apparecchio da giardino per esterni costituita da:

- Palo in alluminio estruso verniciato
- Corpo superiore in alluminio pressofuso verniciato
- Vetri piani temperati
- Parabola riflettente in alluminio
- Guarnizioni in silicone
- Viti di chiusura in acciaio inox
- Verniciatura in polveri poliesteri ad elevata resistenza ai raggi ultravioletti e alla corrosione

Garden post luminaire constructed of:

- Painted extruded aluminium post
- Painted die-cast aluminium head
- Tempered glasses
- Aluminium reflector
- Silicon gaskets
- Stainless steel screws
- Painting using high resistance to UV and corrosion polyester powders



Record Spa



Colori - Colours

X=9  Antracite / Anthracite

X=4  Silver

Diffusore - Diffuser

Codice - Code 00 3034

vetro / glass

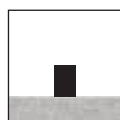

Installazione a terra
Floor mounting

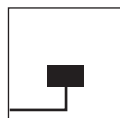

Entrata singola cavi di alimentazione
Single power supply cables input

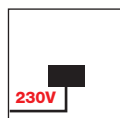

LED
Led a tensione di rete 220/240V 50/60Hz.
Connessione diretta alla rete di alimentazione senza necessità di alimentatore.
LED's direct operation at 220/240V 50/60Hz.
No power supply is required.

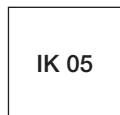

IK 05



ACCESSORIO / ACCESSORY : art. PT74
Questo accessorio serve per chiudere una o più uscite di luce secondo le esigenze di installazione
This part is used to close one or more light openings as for the installation's necessities

OPTIONAL Cod. TR 3038

Flangia: accessorio per palo.
Flange: accessory for post.

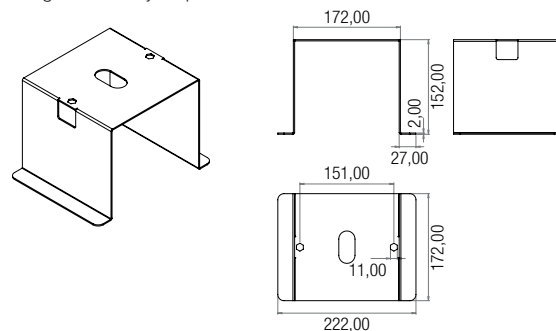

**3035** H 300

3035.00X	LED	10W	E27	
3035.55X	LED	17,6W	2270 lm	4000 K
3035.56X	LED	17,6W	2125 lm	3000 K

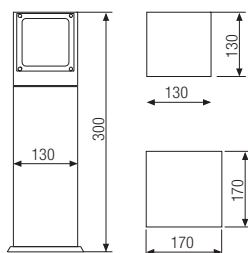
**3036** H 500

3036.00X	LED	10W	E27	
3036.55X	LED	17,6W	2270 lm	4000 K
3036.56X	LED	17,6W	2125 lm	3000 K

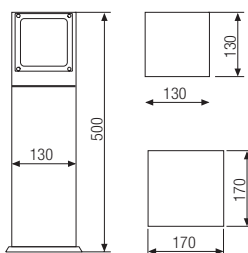
**3038** H 800

3038.00X	LED	10W	E27	
3038.55X	LED	17,6W	2270 lm	4000 K
3038.56X	LED	17,6W	2125 lm	3000 K

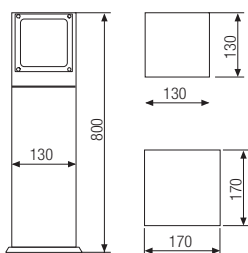

DIXIE

Apparecchio per illuminazione di esterni applicabile a parete costituito da:

- Struttura in alluminio pressofuso verniciato
- Vetro satinato temperato o in policarbonato opale
- Parabola riflettente in alluminio
- Guarnizioni in silicone
- Viti di chiusura in acciaio inox
- Verniciatura in polveri poliestere ad elevata resistenza ai raggi ultravioletti e alla corrosione

Outdoor wall luminaire constructed of:

- Painted die-cast aluminium structure
- Satin tempered glass or opal polycarbonate diffuser
- Aluminium reflector
- Silicon gaskets
- Stainless steel screws
- Painting using high resistance to UV and corrosion polyester powders



DIXIE STELO

Apparecchio da giardino per esterni costituita da:

- Palo in alluminio estruso verniciato
- Corpo superiore in alluminio pressofuso verniciato

Garden post luminaire constructed of:

- Painted extruded aluminium post
- Painted die-cast aluminium head



Colori - Colours

X=9  Antracite / Anthracite

X=4  Silver

Diffusore - Diffuser

Codice-Code 00 7071
vetro / glass

Codice-Code 08 7071
policarbonato / polycarbonate

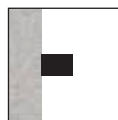

DIXIE
Installazione a parete
Wall mounting

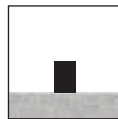

DIXIE STELO
Installazione a terra
Floor mounting

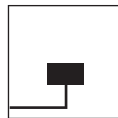

Entrata singola cavi di alimentazione
Single power supply cables input

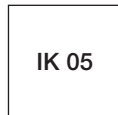

Diffusore in vetro
Glass diffuser



Diffusore in policarbonato
Polycarbonate diffuser

Su richiesta disponibile anche con diffusore in policarbonato
Available also with polycarbonate diffuser on request



ACCESSORIO / ACCESSORY : art. PT76
Questo accessorio serve per chiudere una o più uscite di luce secondo le esigenze di installazione
This part is used to close one or more light openings as for the installation's necessities

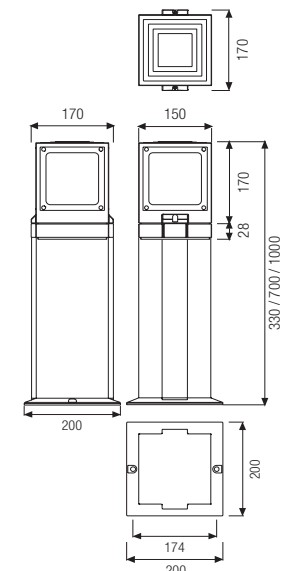
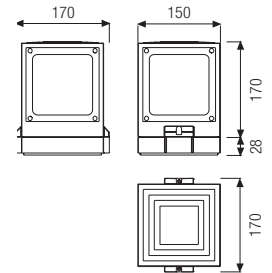

Installazione a parete
Wall mounting



7071

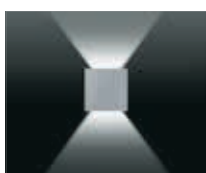

7072



7074

1 apertura 1 opening

7071.00X	LED	12W	E27
-----------------	-----	-----	-----

2 aperture 2 openings

7072.00X	LED	12W	E27
-----------------	-----	-----	-----

4 aperture 4 openings

7074.00X	LED	12W	E27
-----------------	-----	-----	-----

Installazione a terra
Floor mounting



7077 H 330

7076 H 700

7078 H 1000



4 aperture 4 openings

7077.00X	LED	12W	E27
-----------------	-----	-----	-----

4 aperture 4 openings

7076.00X	LED	12W	E27
-----------------	-----	-----	-----

4 aperture 4 openings

7078.00X	LED	12W	E27
-----------------	-----	-----	-----

DIXIE STELO

DIXIE STELO





BLUES



AMOS

BLUES BIG

Apparecchio da parete per illuminazione di esterni costituito da:

- Corpo in alluminio pressofuso verniciato
- Diffusore in vetro temperato e/o lente
- Parabola riflettente in alluminio
- Guarnizioni in silicone
- Viti di chiusura in acciaio inox
- Verniciatura in polveri poliestere ad elevata resistenza ai raggi ultravioletti e alla corrosione

Outdoor direct light wall luminaire constructed of:

- Painted die-cast aluminium body
- Tempered glass and/or lens diffuser
- Aluminium reflector
- Silicon gaskets
- Stainless steel screws
- Painting using high resistance to UV and corrosion polyester powders



Colori - Colours

X=9  Antracite
Anthracite

X=4  Silver

Diffusore - Diffuser

Codice-Code 00 8081

vetro / glass

Codice-Code 04 8083

lente / lens

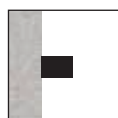

Installazione a parete
Wall mounting

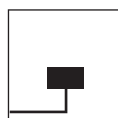

Entrata singola cavi di alimentazione
Single power supply cables input

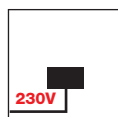

LED

L'apparecchio è fornito completo di alimentatore elettronico 220/240V 50/60Hz posizionato all'interno dell'apparecchio.

The luminaire is supplied with a 220/240V 50/60Hz built-in power supply.

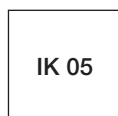

IK 05



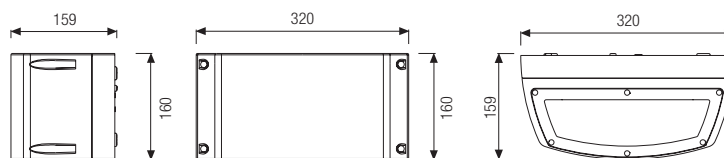

8081

Monodirezionale
Mono direction light

8081.00X	LED	2x12W	E27	
8081.66X	LED	21,6W	2680 lm	4000 K
8081.67X	LED	21,6W	2440 lm	3000 K



8082

Bidirezionale
Double direction light

8082.00X	LED	2x12W	E27	
8082.66X	LED	2x21,6W	2x2680 lm	4000 K
8082.67X	LED	2x21,6W	2x2440 lm	3000 K



8083

Bidirezionale con 1 lente a fascio stretto e 1 vetro
Double direction light with 1 narrow light beam lens and 1 glass

8083.66X	LED	1x21,6W	2680 lm	4000 K
	LED	1x10,8W	1340 lm	4000 K
8083.67X	LED	1x21,6W	2440 lm	3000 K
	LED	1x10,8W	1220 lm	3000 K

BLUES MINI

Apparecchio da parete per illuminazione di esterni costituito da:

- Corpo in alluminio pressofuso verniciato
- Diffusore in vetro temperato e/o lente
- Parabola riflettente in alluminio
- Guarnizioni in silicone
- Viti di chiusura in acciaio inox
- Verniciatura in polveri poliestere ad elevata resistenza ai raggi ultravioletti e alla corrosione

Outdoor direct light wall luminaire constructed of:

- Painted die-cast aluminium body
- Tempered glass and/or lens diffuser
- Aluminium reflector
- Silicon gaskets
- Stainless steel screws
- Painting using high resistance to UV and corrosion polyester powders



Colori - Colours

X=9  Antracite
Anthracite

X=4  Silver

Diffusore - Diffuser

Codice-Code 00 8071
vetro / glass

Codice-Code 04 8073
lente / lens

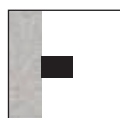

Installazione a parete
Wall mounting

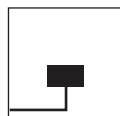

Entrata singola cavi di alimentazione
Single power supply cables input

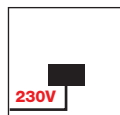

LED
Led a tensione di rete 220/240V 50/60Hz.
Connessione diretta alla rete di alimentazione
senza necessità di alimentatore.
LED's direct operation at 220/240V 50/60Hz.
No power supply is required.

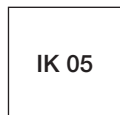

IK 05



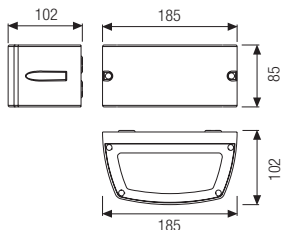

BLUES MINI su richiesta è disponibile anche con fascio luminoso 40°.
BLUES MINI available also with 40° light beam on request.



8071

Monodirezionale con un vetro - Fascio luminoso $\pm 80^\circ$
 Mono direction light with one glass - $\pm 80^\circ$ light beam

8071.66X	LED	6W	800 lm	4000 K
8071.67X	LED	6W	760 lm	3000 K



8072

Bidirezionale con due vetri - Fasci luminosi $\pm 80^\circ$
 Double direction light with two glasses - $\pm 80^\circ$ light beams

8072.66X	LED	2x6W	2x800 lm	4000 K
8072.67X	LED	2x6W	2x760 lm	3000 K



8074

Bidirezionale con 2 lenti $\pm 10^\circ$
 Double direction light with 2 lenses $\pm 10^\circ$

8074.66X	LED	2x6W	2x800 lm	4000 K
8074.67X	LED	2x6W	2x760 lm	3000 K



8073

Bidirezionale con una lente $\pm 10^\circ$ e un vetro fascio luminoso $\pm 80^\circ$
 Double direction light with 1 lens $\pm 10^\circ$ and 1 glass $\pm 80^\circ$ light beam

8073.66X	LED	2x6W	2x800 lm	4000 K
8073.67X	LED	2x6W	2x760 lm	3000 K

AMOS BIG

Apparecchio a parete per illuminazione di esterni ad emissione di luce con varie aperture di fasci luminosi costituito da:

- Struttura in alluminio pressofuso verniciato
- Vetri piani temperati e/o lenti
- Parabola riflettente in alluminio
- Guarnizioni in silicone
- Viti di chiusura in acciaio inox
- Verniciatura in polveri poliestere ad elevata resistenza ai raggi ultravioletti e alla corrosione

Wall outdoor luminaire with various light band openings constructed of:

- Painted die-cast aluminium structure
- Tempered glasses or/and lenses
- Aluminium reflector
- Silicon gaskets
- Stainless steel screws
- Painting using high resistance to UV and corrosion polyester powders



Colori - Colours

X=9  Antracite
Anthracite

X=4  Silver

Diffusore - Diffuser

Codice-Code 00 8021
vetro / glass

Codice-Code 04 8022
lente tonda / round lens

Codice-Code 04 8023
lente rettangolare / rectangular lens

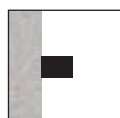

Installazione a parete
Wall mounting

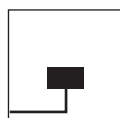

Entrata singola cavi di alimentazione
Single power supply cables input

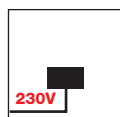

L'apparecchio è fornito completo di alimentatore elettronico 220/240V 50/60Hz posizionato all'interno dell'apparecchio.
The luminaire is supplied with a 220/240V 50/60Hz built-in power supply.

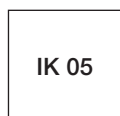

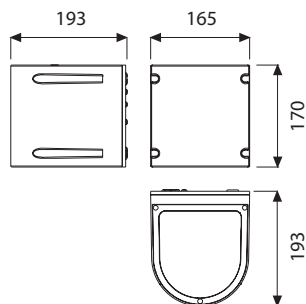

Bidirezionale

Double direction light

8020.55X	LED	2x8W	2x1400 lm	4000 K
8020.56X	LED	2x8W	2x1400 lm	3000 K



8020

Monodirezionale

Mono direction light

8021.00X	LED	12W	E27	
8021.55X	LED	8W	1400 lm	4000 K
8021.56X	LED	8W	1400 lm	3000 K



8021

Bidirezionale con 1 lente e un vetro

Double direction light with 1 lens and 1 glass

8022.55X	LED	2x10W	2x1800 lm	4000 K
8022.56X	LED	2x10W	2x1800 lm	3000 K
8022.35X	 HIT	35W	G12	



8022

Bidirezionale con 1 lente a fascio stretto e un vetro

Double direction light with 1 narrow light beam lens and 1 glass

8023.55X	LED	2x8W	2x1400 lm	4000 K
8023.56X	LED	2x8W	2x1400 lm	3000 K



8023

AMOS MINI

Apparecchio da parete per illuminazione di interni e di esterni ad emissione di luce con varie aperture di fasci luminosi costituito da:

- Struttura in alluminio pressofuso verniciato
- Vetri piani temperati e/o lenti
- Parabola riflettente in alluminio
- Guarnizioni in silicone
- Viti di chiusura in acciaio inox
- Verniciatura in polveri poliestere ad elevata resistenza ai raggi ultravioletti e alla corrosione

Wall outdoor and indoor luminaire with various light beams constructed of:

- Painted die-cast aluminium structure
- Tempered glasses or/and lenses
- Aluminium reflector
- Silicon gaskets
- Stainless steel screws
- Painting using high resistance to UV and corrosion polyester powders



Colori - Colours

X=9  Antracite
Anthracite

X=4  Silver

Diffusore - Diffuser

Codice-Code 00 8091

vetro / glass

Codice-Code 04 8093

lente rettangolare / rectangular lens

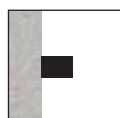

Installazione a parete
Wall mounting

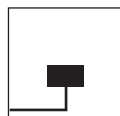

Entrata singola cavi di alimentazione
Single power supply cables input

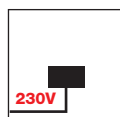

LED
Led a tensione di rete 220/240V 50/60Hz.
Connessione diretta alla rete di alimentazione
senza necessità di alimentatore.
LED's direct operation at 220/240V 50/60Hz.
No power supply is required.



Lampadina LED GU10 IP20 dimmerabile
LED GU10 IP20 dimmable bulb

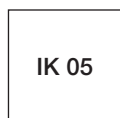

IK 05



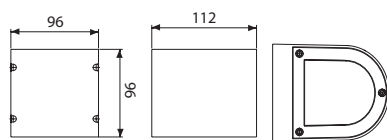

AMOS MINI su richiesta è disponibile anche con fascio luminoso 40°.
 AMOS MINI available also with 40° light beam on request.



8091

Monodirezionale con un vetro - Fascio luminoso $\pm 70^\circ$

Mono direction light with one glass - $\pm 70^\circ$ light beam

8091.66X	LED	4W	510 lm	4000 K
8091.67X	LED	4W	500 lm	3000 K
• 8091.05X	LED GU10	4,9W	560 lm	4000 K
• 8091.06X	LED GU10	4,9W	560 lm	3000 K



8092

Bidirezionale con due vetri - Fasci luminosi $\pm 70^\circ$

Double direction light with two glasses - $\pm 70^\circ$ light beams

8092.66X	LED	2x4W	2x510 lm	4000 K
8092.67X	LED	2x4W	2x500 lm	3000 K



8093

Bidirezionale con una lente $\pm 10^\circ$ e un vetro fascio luminoso $\pm 70^\circ$

Double direction light with 1 lens $\pm 10^\circ$ and 1 glass $\pm 70^\circ$ light beam

8093.66X	LED	2x4W	2x510 lm	4000 K
8093.67X	LED	2x4W	2x500 lm	3000 K

- L'apparecchio viene fornito completo di lampadina
 Bulb enclosed with the luminaire

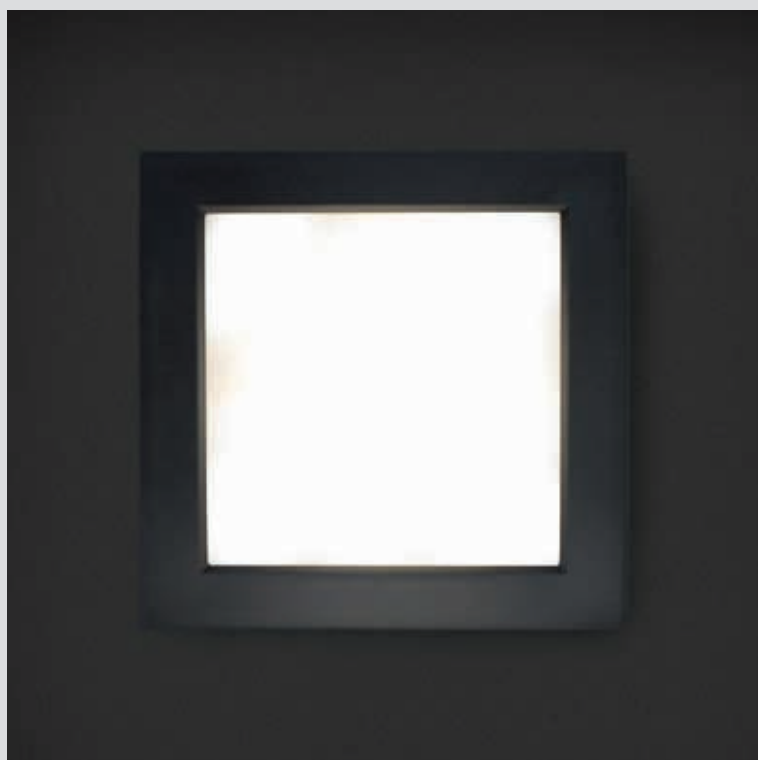



BLOCK



MEG

BLOCK/MEG

Apparecchio per illuminazione di esterni e/o di interni, disponibile in due dimensioni BIG e MINI costituito da:

- Corpo in alluminio pressofuso verniciato
- Diffusore in vetro temperato
- Guarnizioni in silicone
- Viti di chiusura in acciaio inox
- Verniciatura in polveri poliesteri ad elevata resistenza ai raggi ultravioletti e alla corrosione

Outdoor and/or indoor luminaire, available in two sizes BIG and MINI constructed of:

- Painted die-cast aluminium body
- Tempered glass diffuser
- Silicon gaskets
- Stainless steel screws
- Painting using high resistance to UV and corrosion polyester powders



Colori - Colours

X=9  Antracite

X=4  Silver

Diffusore - Diffuser

Codice-Code 00 7050
per/for **BLOCK MINI**

Codice-Code 00 7060
per/for **BLOCK BIG**

Codice-Code 00 7010
per/for **MEG MINI**

Codice-Code 00 7020
per/for **MEG BIG**

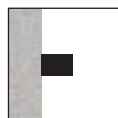

Installazione a parete
Wall mounting



Installazione a soffitto
Ceiling mounting

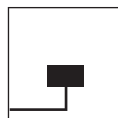

BLOCK / MEG MINI
Entrata singola cavi di alimentazione
Single power supply cables input

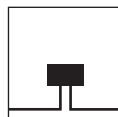

BLOCK / MEG BIG
Doppia entrata cavi di alimentazione
Double power supply cables input

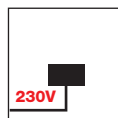

LED ART 7050 - 7060 - 7010
Led a tensione di rete 220/240V 50/60Hz.
Connessione diretta alla rete di alimentazione
senza necessità di alimentatore.
LED's direct operation at 220/240V 50/60Hz.
No power supply is required.

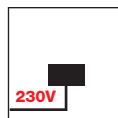

LED ART 7020
L'apparecchio è fornito completo di alimentatore elettronico 220/240V 50/60Hz
posizionato all'interno dell'apparecchio.
The luminaire is supplied with a 220/240V 50/60Hz
built-in power supply

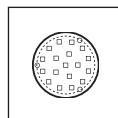

ART. 7010.68/69 LED Gx53
Non necessita di alcun alimentatore.
It does not need the power supply.



IK 05



L'apparecchio **BLOCK** può essere installato sia orizzontale sia verticale

BLOCK luminaire can be installed both horizontal and vertical

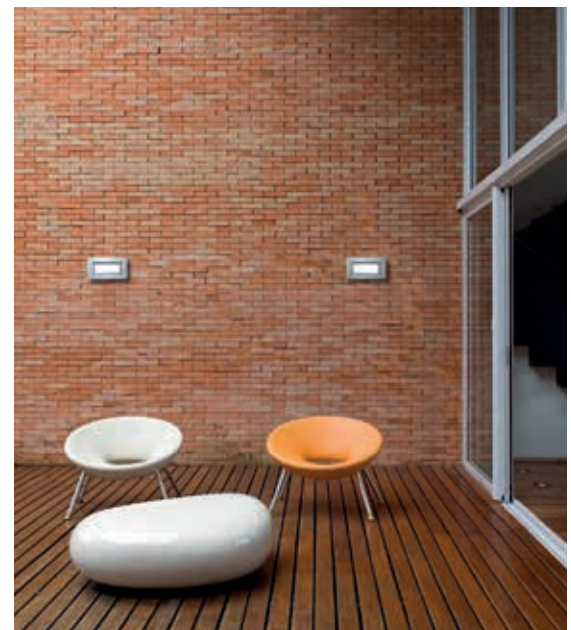



7050 MINI

7050.55X	LED	9W	1240 lm	4000 K
7050.56X	LED	9W	1160 lm	3000 K

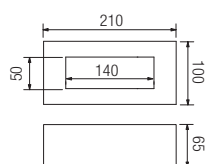

7060 BIG

7060.55X	LED	13W	1790 lm	4000 K
7060.56X	LED	13W	1790 lm	3000 K

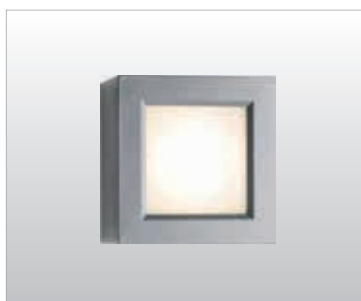
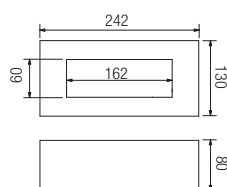

7010 MINI

● 7010.68X	●	LED	6,5W	GX53	650 lm	4000 K
● 7010.69X	●	LED	6,5W	GX53	650 lm	3000 K
7010.45X		LED	8,7W		1120 lm	4000 K
7010.46X		LED	8,7W		1050 lm	3000 K

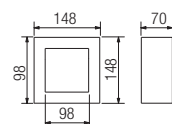

7020 BIG

7020.25X	LED	20W	2350 lm	4000 K
7020.26X	LED	20W	2350 lm	3000 K

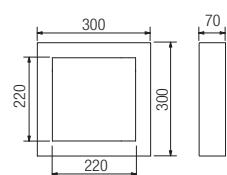

- L'apparecchio viene fornito completo di lampadina
Bulb enclosed with the luminaire

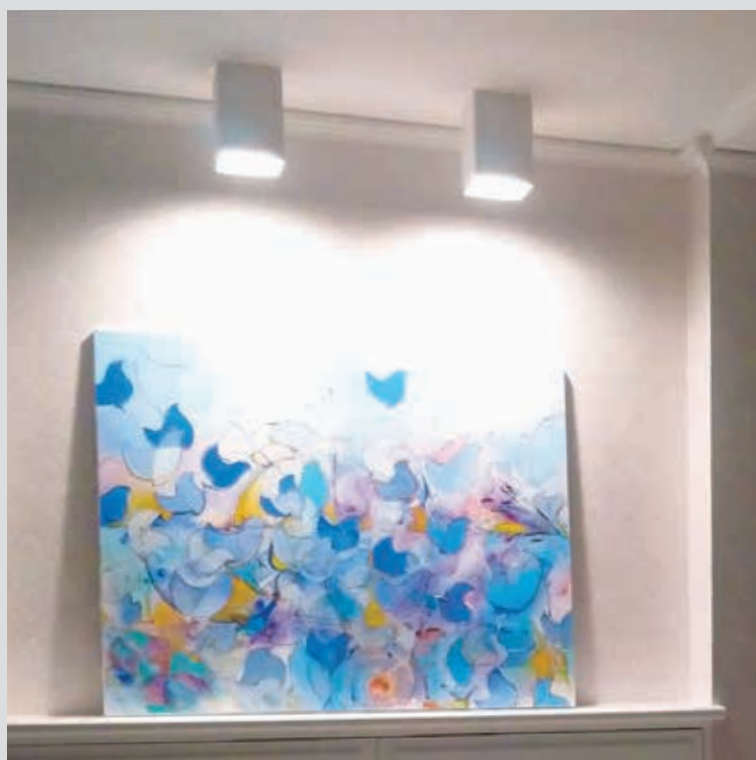



N 07

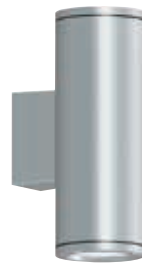

BLITZ



BLITZ QUAD



HALF

N 07

Proiettore orientabile per esterni ed interni applicabile a parete costituito da:

- Corpo in alluminio pressofuso verniciato
- Diffusore in vetro temperato satinato
- Guarnizioni in silicone
- Viti di chiusura in acciaio inox
- Verniciatura in polveri poliestere ad elevata resistenza ai raggi ultravioletti e alla corrosione

Adjustable indoor and outdoor wall spotlight constructed of:

- Painted die-cast aluminium body
- Satin glass diffuser
- Silicon gaskets
- Stainless steel screws
- Painting using high resistance to UV and corrosion polyester powders



Colori - Colours

X=9  Antracite
Anthracite

X=4  Silver

Diffusore - Diffuser

Codice-Code 00 9070

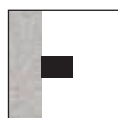

Installazione a parete
Wall mounting

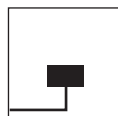

Entrata singola cavi di alimentazione
Single power supply cables input



Lampadina LED GU10 IP20 dimmerabile
LED GU10 IP20 dimmable bulb



IK 05

APPARECCHIO ORIENTABILE DA 0° A 90°
ADJUSTABLE FROM 0° TO 90°



9070



- **9070.05X**  **LED GU10** 4,9W 560 lm 4000 K
- **9070.06X**  **LED GU10** 4,9W 560 lm 3000 K

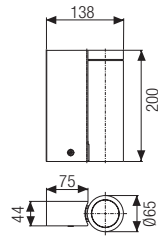

APPARECCHIO ORIENTABILE DA 0° A 90°
ADJUSTABLE FROM 0° TO 90°

- **L'apparecchio viene fornito completo di lampadina**
Bulb enclosed with the luminaire

BLITZ

Apparecchio a sezione cilindrica a parete o a soffitto per esterni a uno o a due fasci luminosi; è disponibile in diverse dimensioni. È costituito da:

- Corpo in alluminio estruso e in alluminio pressofuso verniciato
- Diffusore in vetro temperato
- Parabola riflettente in alluminio
- Guarnizioni in silicone
- Viti di chiusura in acciaio inox
- Verniciatura in polveri poliestere ad elevata resistenza ai raggi ultravioletti e alla corrosione

One or two light beams outdoor wall or ceiling cylindrical section luminaire available in different sizes. It is constructed of:

- Extruded and die-casted aluminium body
- Tempered glass diffuser
- Aluminium reflector
- Silicon gaskets
- Stainless steel screws
- Painting using high resistance to UV and corrosion polyester powders



Colori - Colours

X=9  Anthracite
Anthracite

X=4  Silver

Diffusore - Diffuser

Codice-Code **00 9061**
00 9071

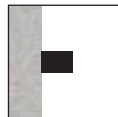

Installazione a parete
Wall mounting



Lampadina LED GU10 IP20 dimmerabile
LED GU10 IP20 dimmable bulb



Cod. 9067 - 9077
Installazione a soffitto
Ceiling mounting



Lampadina LED PAR30 IP65 dimmerabile
LED PAR30 IP65 dimmable bulb

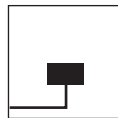

Entrata singola cavi di alimentazione
Single power supply cables input

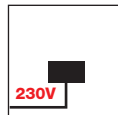

LED BLITZ Ø93 e
BLITZ Ø130 Cod. 9061 - 9064 - 9067
Led a tensione di rete 220/240V 50/60Hz.
Connessione diretta alla rete di alimentazione
senza necessità di alimentatore.
LED's direct operation at 220/240V 50/60Hz.
No power supply is required.

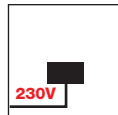

LED Cod. 9068 - 9069
L'apparecchio è fornito completo di alimentatore elettronico 220/240V 50/60Hz posizionato all'interno dell'apparecchio.
The luminaire is supplied with a 220/240V 50/60Hz built-in power supply



IK 07





9075 - 9076 Ø 93



Monodirezionale
Mono direction light

9075.66X	LED	4W	510 lm	4000 K
9075.67X	LED	4W	500 lm	3000 K
● 9075.05X	LED GU10	4,9W	560 lm	4000 K
● 9075.06X	LED GU10	4,9W	560 lm	3000 K



Bidirezionale
Double direction light

9076.66X	LED	2x4W	2x510 lm	4000 K
9076.67X	LED	2x4W	2x500 lm	3000 K

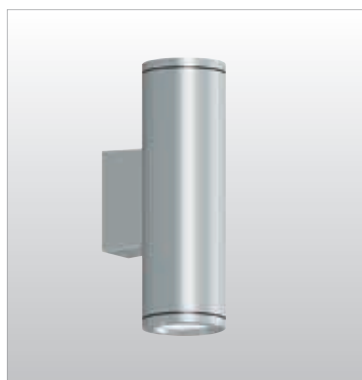
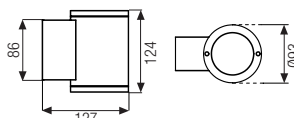

9071 - 9072 Ø 93



Monodirezionale
Mono direction light

9071.66X	LED	4W	510 lm	4000 K
9071.67X	LED	4W	500 lm	3000 K
● 9071.05X	LED GU10	4,9W	560 lm	4000 K
● 9071.06X	LED GU10	4,9W	560 lm	3000 K



Bidirezionale
Double direction light

9072.66X	LED	2x4W	2x510 lm	4000K
9072.67X	LED	2x4W	2x500 lm	3000K
● 9072.05X	LED GU10	2x4,9W	2x560 lm	4000K
● 9072.06X	LED GU10	2x4,9W	2x560 lm	3000K

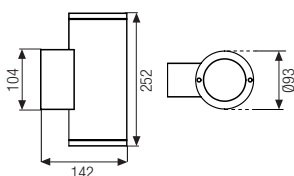

9077 Ø 93
a soffitto/ceiling mounting



Monodirezionale
Mono direction light

9077.66X	LED	4W	510 lm	4000 K
9077.67X	LED	4W	500 lm	3000 K
● 9077.05X	LED GU10	4,9W	560 lm	4000 K
● 9077.06X	LED GU10	4,9W	560 lm	3000 K

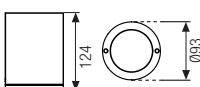

- L'apparecchio viene fornito completo di lampadina
Bulb enclosed with the luminaire

BLITZ Ø130

BLITZ Ø130



9061 Ø 130



Monodirezionale Mono direction light

- **9061.05X** LED PAR30 E27 9,5W 800 lm 4000 K 40°
- **9061.06X** LED PAR30 E27 9,5W 800 lm 3000 K 40°

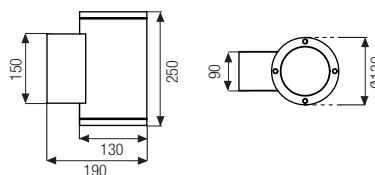

9062 Ø 130



Bidirezionale Double direction light

- **9062.05X** LED PAR30 E27 2x9,5W 2x800 lm 4000 K 40°
- **9062.06X** LED PAR30 E27 2x9,5W 2x800 lm 3000 K 40°

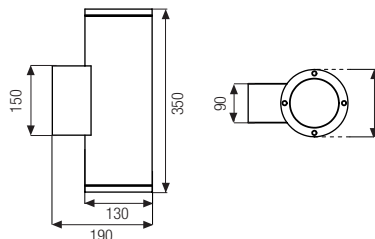

9067 Ø 130
a soffitto/ceiling mounting



Monodirezionale Mono direction light

- **9067.05X** LED PAR30 E27 9,5W 800 lm 4000 K 40°
- **9067.06X** LED PAR30 E27 9,5W 800 lm 3000 K 40°
- **9067.45X** LED 17,6W 2270 lm 4000 K
- **9067.46X** LED 17,6W 2125 lm 3000 K

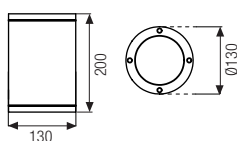

- L'apparecchio viene fornito completo di lampadina
Bulb enclosed with the luminaire

BLITZ Ø130 LED è disponibile in varie ottiche : 16°, 40°, 74°.

BLITZ Ø130 LED is available in various optics : 16°, 40°, 74°.

BLITZ Ø130 LED dispone di circuiti LED basculanti ± 15°.

BLITZ Ø130 LED provided with tiltable ± 15° LED modules.



9068 Ø 130



Bidirezionale
Double direction light

9068.66.16X	LED COB	2x15,6W	2x2620 lm	4000 K	16°
9068.67.16X	LED COB	2x15,6W	2x2520 lm	3000 K	16°
9068.66.40X	LED COB	2x15,6W	2x2620 lm	4000 K	40°
9068.67.40X	LED COB	2x15,6W	2x2520 lm	3000 K	40°
9068.66.74X	LED COB	2x15,6W	2x2620 lm	4000 K	74°
9068.67.74X	LED COB	2x15,6W	2x2520 lm	3000 K	74°

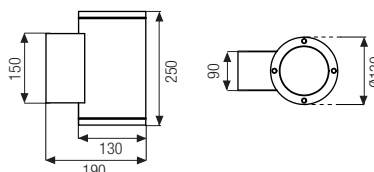

9069 Ø 130



Monodirezionale
Mono direction light

9069.66.16X	LED COB	15,6W	2620 lm	4000 K	16°
9069.67.16X	LED COB	15,6W	2520 lm	3000 K	16°
9069.66.40X	LED COB	15,6W	2620 lm	4000 K	40°
9069.67.40X	LED COB	15,6W	2520 lm	3000 K	40°
9069.66.74X	LED COB	15,6W	2620 lm	4000 K	74°
9069.67.74X	LED COB	15,6W	2520 lm	3000 K	74°

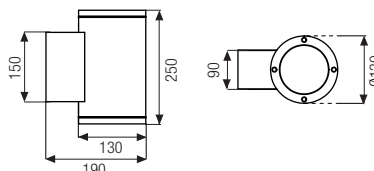

BLITZ Ø130 LED Cod. 9061 - 9064 : illuminazione a fascio largo.

BLITZ Ø130 LED Cod. 9061 - 9064 : wide beam.



9061 - 9064 LED Ø 130



Bidirezionale
Double direction light

9064.45X	LED	2x17,6W	2x2270 lm	4000 K
9064.46X	LED	2x17,6W	2x2125 lm	3000 K



Monodirezionale
Mono direction light

9061.45X	LED	17,6W	2270 lm	4000 K
9061.46X	LED	17,6W	2125 lm	3000 K

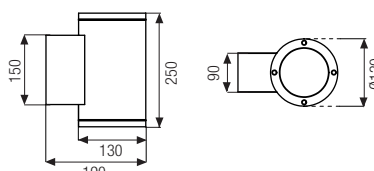

BLITZ QUAD

Apparecchio a sezione quadrata a parete o a soffitto per esterni a uno o a due fasci luminosi; è disponibile in diverse dimensioni. È costituito da:

- Corpo in alluminio estruso e in alluminio pressofuso verniciato
- Diffusore in vetro temperato
- Parabola riflettente in alluminio
- Guarnizioni in silicone
- Viti di chiusura in acciaio inox
- Verniciatura in polveri poliestere ad elevata resistenza ai raggi ultravioletti e alla corrosione

One or two light beams outdoor wall or ceiling square section luminaire available in different sizes. It is constructed of:

- Extruded and die-casted aluminium body
- Tempered glass diffuser
- Aluminium reflector
- Silicon gaskets
- Stainless steel screws
- Painting using high resistance to UV and corrosion polyester powders



Colori - Colours

X=9  Anthracite
Anthracite

X=4  Silver

Diffusore - Diffuser

Codice-Code 00 9015
00 9025
00 9085
00 9095

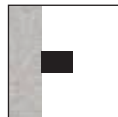

Installazione a parete
Wall mounting



Cod. 9087 - 9097
Installazione a soffitto
Ceiling mounting

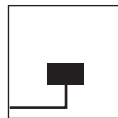

Entrata singola cavi di alimentazione
Single power supply cables input

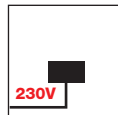

LED BLITZ QUAD 80 - 100 - 150
 130 Cod. 9094 - 9095 - 9097
Led a tensione di rete 220/240V 50/60Hz.
Connessione diretta alla rete di alimentazione senza necessità di alimentatore.
LED's direct operation at 220/240V 50/60Hz.
No power supply is required.

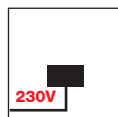

LED Cod. 9098 - 9099
L'apparecchio è fornito completo di alimentatore elettronico 220/240V 50/60Hz posizionato all'interno dell'apparecchio.
The luminaire is supplied with a 220/240V 50/60Hz built-in power supply.



IK 07



Lampadina LED GU10 IP20 dimmerabile
LED GU10 IP20 dimmable bulb



Lampadina LED PAR30 IP65 dimmerabile
LED PAR30 IP65 dimmable bulb

BLITZ QUAD \square 80/100

BLITZ QUAD \square 80/100



9015 - 9016 \square 80



Monodirezionale - Mono direction light

9015.66X	LED	4W	510 lm	4000 K
9015.67X	LED	4W	500 lm	3000 K
• 9015.05X	LED GU10	4,9W	560 lm	4000 K
• 9015.06X	LED GU10	4,9W	560 lm	3000 K



Bidirezionale - Double direction light

9016.66X	LED	2x4W	2x510 lm	4000 K
9016.67X	LED	2x4W	2x500 lm	3000 K

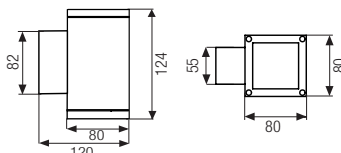

9017 - 9018 \square 80



Monodirezionale - Mono direction light

9017.66X	LED	4W	510 lm	4000 K
9017.67X	LED	4W	500 lm	3000 K
• 9017.05X	LED GU10	4,9W	560 lm	4000 K
• 9017.06X	LED GU10	4,9W	560 lm	3000 K



Bidirezionale - Double direction light

9018.66X	LED	2x4W	2x510 lm	4000 K
9018.67X	LED	2x4W	2x500 lm	3000 K
• 9018.05X	LED GU10	2x4,9W	2x560 lm	4000 K
• 9018.06X	LED GU10	2x4,9W	2x560 lm	3000 K

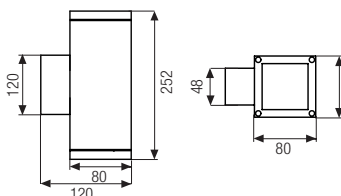

9085 \square 100



Monodirezionale - Mono direction light

9085.45X	LED	8,7W	1120 lm	4000 K
9085.46X	LED	8,7W	1050 lm	3000 K
• 9085.05X	LED GU10	4,9W	560 lm	4000 K
• 9085.06X	LED GU10	4,9W	560 lm	3000 K

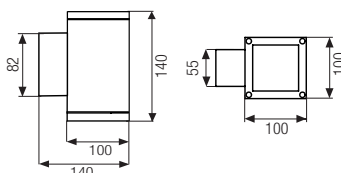

9088 \square 100



Bidirezionale - Double direction light

9088.45X	LED	2x8,7W	2x1120 lm	4000 K
9088.46X	LED	2x8,7W	2x1050 lm	3000 K
• 9088.05X	LED GU10	2x4,9W	2x560 lm	4000 K
• 9088.06X	LED GU10	2x4,9W	2x560 lm	3000 K

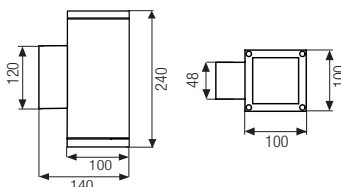

- L'apparecchio viene fornito completo di lampadina
Bulb enclosed with the luminaire

BLITZ QUAD LED \square 130

BLITZ QUAD LED \square 130

BLITZ QUAD LED è disponibile in varie ottiche : 16°, 40°, 74°.
 BLITZ QUAD LED is available in various optics : 16°, 40°, 74°.

BLITZ QUAD LED dispone di circuiti LED basculanti \pm 15°.
 BLITZ QUAD LED provided with tiltable \pm 15° LED module.



9098 \square 130



Bidirezionale - Double direction light

9098.66.16X	LED COB	2x15,6W	2x2620 lm	4000 K	16°
9098.67.16X	LED COB	2x15,6W	2x2520 lm	3000 K	16°
9098.66.40X	LED COB	2x15,6W	2x2620 lm	4000 K	40°
9098.67.40X	LED COB	2x15,6W	2x2520 lm	3000 K	40°
9098.66.74X	LED COB	2x15,6W	2x2620 lm	4000 K	74°
9098.67.74X	LED COB	2x15,6W	2x2520 lm	3000 K	74°

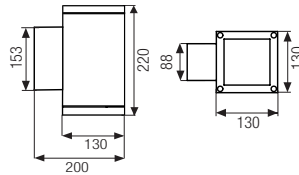

9099 \square 130



Monodirezionale - Mono direction light

9099.66.16X	LED COB	15,6W	2620 lm	4000 K	16°
9099.67.16X	LED COB	15,6W	2520 lm	3000 K	16°
9099.66.40X	LED COB	15,6W	2620 lm	4000 K	40°
9099.67.40X	LED COB	15,6W	2520 lm	3000 K	40°
9099.66.74X	LED COB	15,6W	2620 lm	4000 K	74°
9099.67.74X	LED COB	15,6W	2520 lm	3000 K	74°

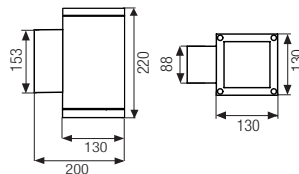

BLITZ QUAD LED Cod. 9094 - 9095 : illuminazione a fascio largo.
 BLITZ QUAD LED Cod. 9094 - 9095 : wide beam.



9094 - 9095 LED \square 130



Bidirezionale - Double direction light

9094.45X	LED	2x17,6W	2x2270 lm	4000 K	
9094.46X	LED	2x17,6W	2x2125 lm	3000 K	



Monodirezionale - Mono direction light

9095.45X	LED	17,6W	2270 lm	4000 K	
9095.46X	LED	17,6W	2125 lm	3000 K	
● 9095.05X	LED PAR30 E27	9,5W	800 lm	4000 K	40°
● 9095.06X	LED PAR30 E27	9,5W	800 lm	3000 K	40°

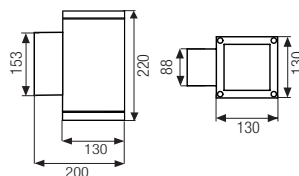

● L'apparecchio viene fornito completo di lampadina
 Bulb enclosed with the luminaire

BLITZ QUAD A SOFFITTO

BLITZ QUAD A SOFFITTO



9087 □ 100
a soffitto/ceiling mounting



Monodirezionale - Mono direction light

9087.45X	LED	8,7W	1120 lm	4000 K
9087.46X	LED	8,7W	1050 lm	3000 K
● 9087.05X	LED GU10	4,9W	560 lm	4000 K
● 9087.06X	LED GU10	4,9W	560 lm	3000 K

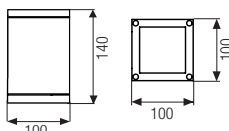

9097 □ 130
a soffitto/ceiling mounting



Monodirezionale - Mono direction light

9097.45X	LED	17,6W	2270 lm	4000 K
9097.46X	LED	17,6W	2125 lm	3000 K
● 9097.05X	LED PAR30 E27	9,5W	800 lm	4000 K 40°
● 9097.06X	LED PAR30 E27	9,5W	800 lm	3000 K 40°

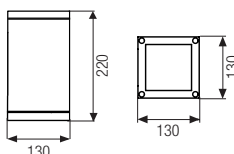

BLITZ QUAD □ 150

BLITZ QUAD □ 150



9024 - 9025 □ 150



Monodirezionale - Mono direction light

9025.45X	LED	17,6W	2270 lm	4000 K
9025.46X	LED	17,6W	2125 lm	3000 K



Bidirezionale - Double direction light

9024.45X	LED	2x17,6W	2x2270 lm	4000 K
9024.46X	LED	2x17,6W	2x2125 lm	3000 K

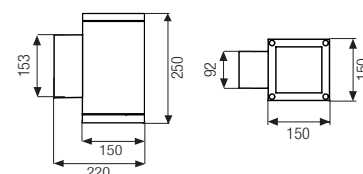

- L'apparecchio viene fornito completo di lampadina
Bulb enclosed with the luminaire

HALF

Apparecchio per esterni a parete o a soffitto.

Disponibile in due dimensioni:

HALF 130

HALF 150

È costituito da:

- Corpo in alluminio estruso e in alluminio pressofuso verniciato
- Diffusore in vetro temperato
- Parabola riflettente in alluminio
- Guarnizioni in silicone
- Viti di chiusura in acciaio inox
- Verniciatura in polveri poliestere ad elevata resistenza ai raggi ultravioletti e alla corrosione

Outdoor wall or ceiling luminaire available in 2 different sizes:

HALF 130

HALF 150

It is constructed of:

- Extruded or die-casted aluminium body
- Tempered glass diffuser
- Aluminium reflector
- Silicon gaskets
- Stainless steel screws
- Painting using high resistance to UV and corrosion polyester powders



Colori - Colours

X=9  Antracite
Anthracite

X=4  Silver

Diffusore - Diffuser

Codice-Code 00 7012

00 7014

00 7017

00 7027

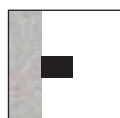
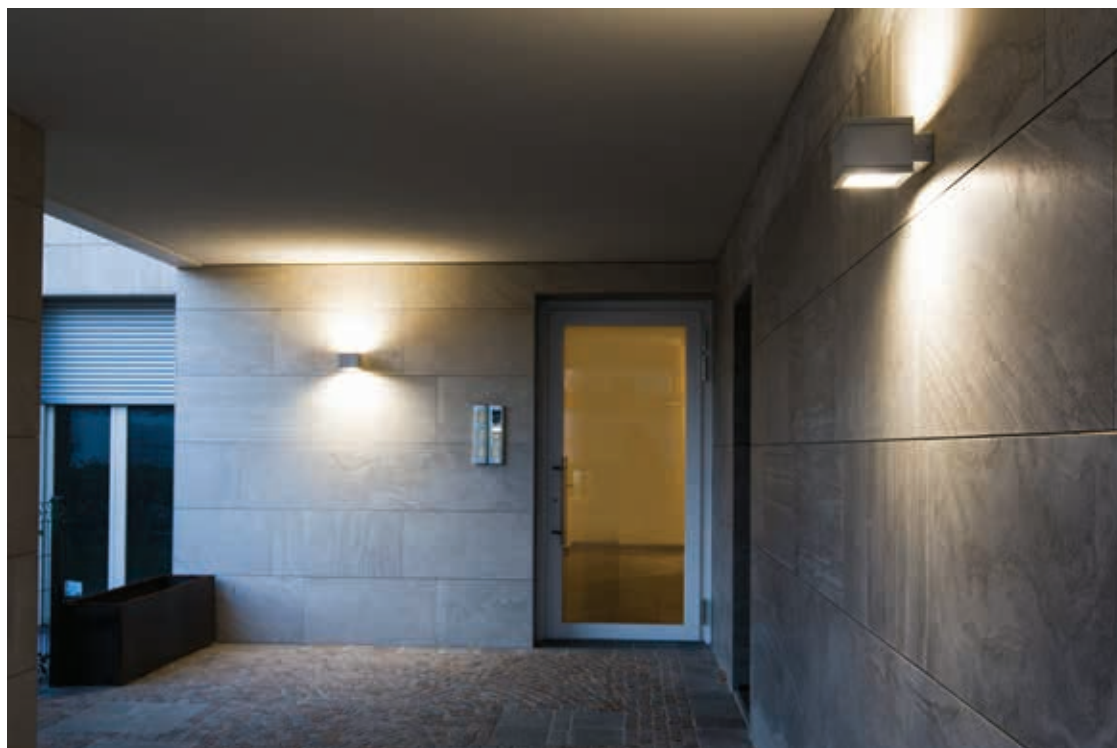

Cod. 7011 - 7012 - 7013 - 7014

Installazione a parete

Wall mounting



Cod. 7017 - 7027

Installazione a soffitto

Ceiling mounting

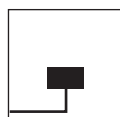

Entrata singola cavi di alimentazione

Single power supply cables input

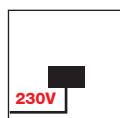

LED per/for cod. 7017 - 7027

Led a tensione di rete 220/240V 50/60Hz.

Connessione diretta alla rete di alimentazione

senza necessità di alimentatore.

LED's direct operation at 220/240V 50/60Hz.

No power supply is required.

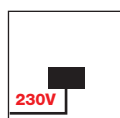

LED per/for cod. 7011 - 7012 - 7013 - 7014

L'apparecchio è fornito completo di

alimentatore elettronico 220/240V 50/60Hz

posizionato all'interno dell'apparecchio.

The luminaire is supplied with a 220/240V 50/60Hz

built-in power supply.



IK 07

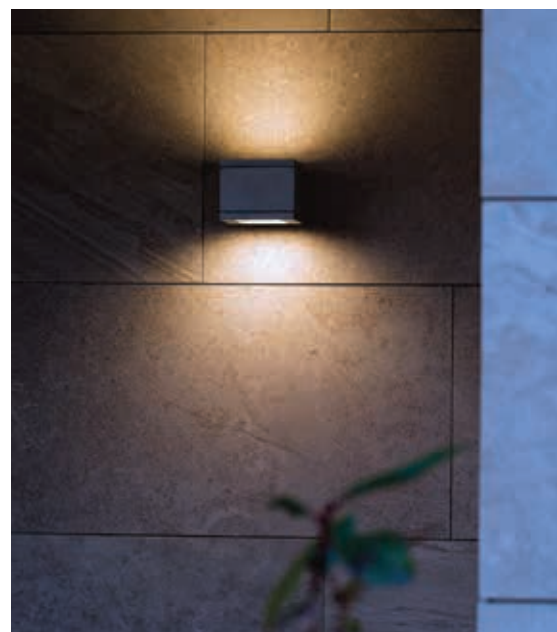



7011 - 7012 HALF 130



Monodirezionale - Mono direction light

7011.45X	LED	8W	1400 lm	4000 K
7011.46X	LED	8W	1400 lm	3000 K



Bidirezionale - Double direction light

7012.45X	LED	2x8W	2x1400 lm	4000 K
7012.46X	LED	2x8W	2x1400 lm	3000 K

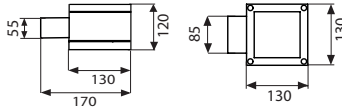

7017 HALF 130
a soffitto/ceiling mounting

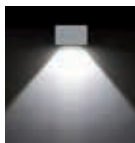

Monodirezionale - Mono direction light

7017.45X	LED	8,7W	1120 lm	4000 K
7017.46X	LED	8,7W	1050 lm	3000 K

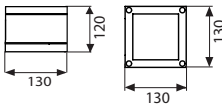

7013 - 7014 HALF 150



Monodirezionale - Mono direction light

7013.45X	LED	8W	1400 lm	4000 K
7013.46X	LED	8W	1400 lm	3000 K



Bidirezionale - Double direction light

7014.45X	LED	2x8W	2x1400 lm	4000 K
7014.46X	LED	2x8W	2x1400 lm	3000 K

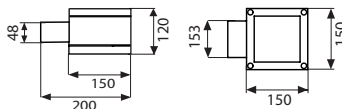

7027 HALF 150
a soffitto/ceiling mounting

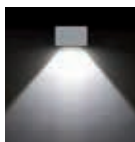

Monodirezionale - Mono direction light

7027.45X	LED	17,6W	2270 lm	4000 K
7027.46X	LED	17,6W	2125 lm	3000 K

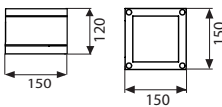

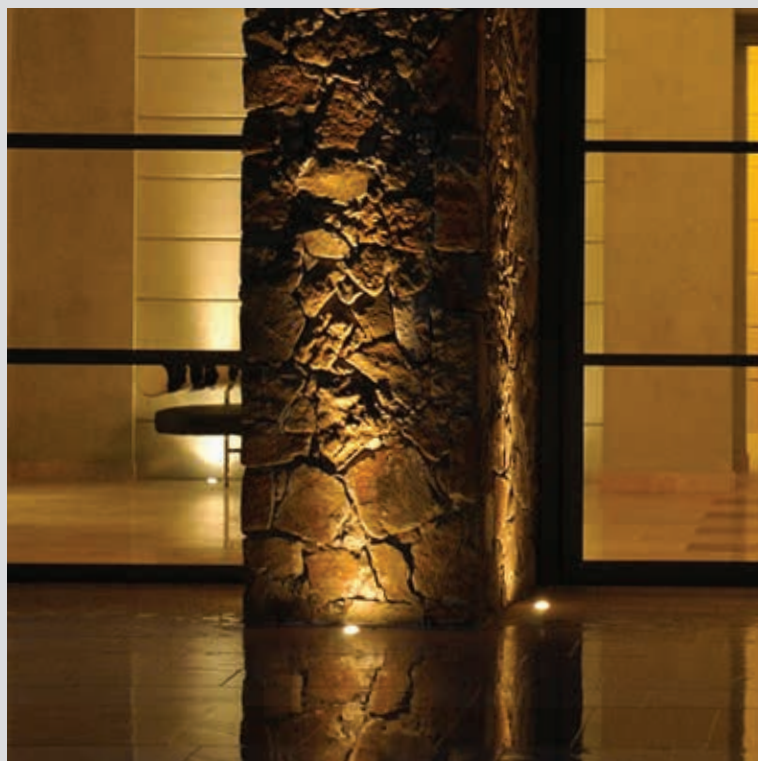



PIXEL



OCEAN



DROP

PIXEL

Apparecchio da incasso a terra per esterni ed interni costituito da:

- Struttura in alluminio
- Copertura in acciaio inox AISI 316L
- Diffusore in policarbonato
- Lente 60°
- Cavo in FEP + neoprene L 1000 mm
- Guarnizione in silicone
- Cassaforma in PVC

Outdoor and indoor recessed ground luminaire constructed of:

- Aluminium structure
- Stainless steel AISI 316L cover
- Polycarbonate diffuser
- Lens 60°
- FEP + neoprene cable L 1000 mm
- Silicon gasket
- PVC holder

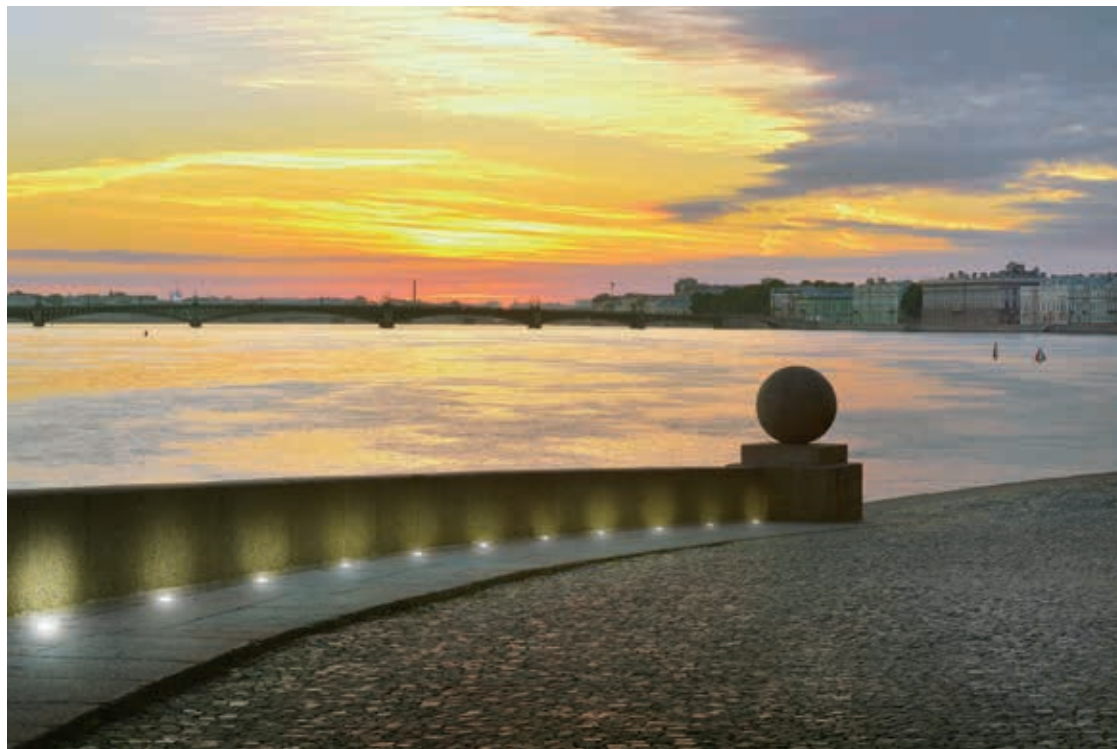

Diffusore - Diffuser
Codice-Code 00 3801
00 3802

Gli apparecchi vengono forniti completi di cassaforma
The holder is enclosed with the luminaire



Incasso a terra
Recessed ground version

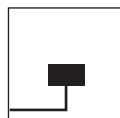

Entrata singola cavi di alimentazione
Single power supply cables input

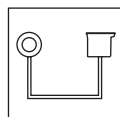

LED
L'apparecchio necessita di alimentatore remoto elettronico (fornito solo su richiesta)
The luminaire needs a remote power supply (supplied only on request)

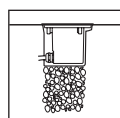

La cassaforma deve essere installata a filo terreno, prevedendo ghiaia di drenaggio per almeno 30 cm.
Ground luminaire. The box must be recessed into the ground providing a drainage-gravel for at least 30 cm



Apparecchio calpestabile
Walkable luminaire



IK 10

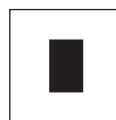

cod. CS 01
Cassaforma in tecnopolimero per vano ad incasso Ø 24 mm - h 100 mm
Technopolymer holder Ø 24 mm - h 100 mm



cod. CS 02
Cassaforma in tecnopolimero per vano ad incasso Ø 50 mm - h 100 mm
Technopolymer holder Ø 50 mm - h 100 mm



Simbolo che indica la temperatura delle superfici toccabili
Symbol indicating the temperature of the touchable surfaces

Temperatura superficie (ta 15°C)	Zona di installazione:
Surface temperature (ta 15°C)	Intended usage:
LED	2

NOTA: zona di installazione definita dalla norma EN 60598-2-13 Allegato A - Vedi pag. 348

Note: intended usage is defined by the standard EN 60598-2-13 Annex A - See pag. 348

OPTIONAL

Per collegamento in parallelo
for parallel connection

cod. CN 24
sistema di congiunzione IP67
con driver 350 mA / 500 mA / 700 mA
a 2 poli, 3 vie
per cavo Ø 4÷9,5 mm
IP67 connecting device
with driver 350 mA / 500 mA / 700 mA
with 2 poles, 3 ways
for cables Ø 4÷9,5 mm

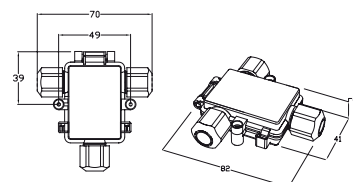

Apparecchio da incasso a terra o a parete con ottica asimmetrica 45° (calpestabile).
Recessed ground or wall luminaire with 45° asymmetric optics (walkable).



3801 Ø 25 - **3802** Ø 55

3801.660	LED	1W	110 lm	4000 K	60°
3801.670	LED	1W	98 lm	3000 K	60°

3802.660	LED	4W	370lm	4000 K	60°
3802.670	LED	4W	320lm	3000 K	60°

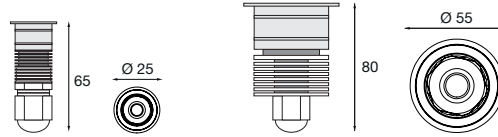

3805 Ø 25 - **3825** Ø 55

3805.660	LED	1W	110 lm	4000 K	60°
3805.670	LED	1W	98 lm	3000 K	60°

3825.660	LED	4W	370lm	4000 K	60°
3825.670	LED	4W	320lm	3000 K	60°

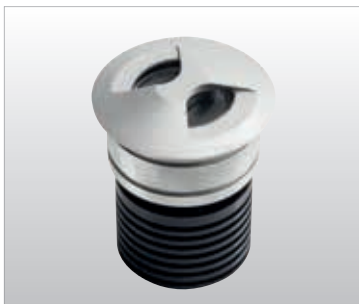
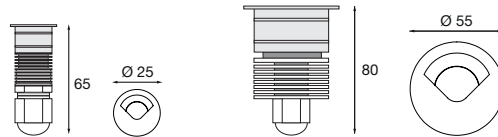

3804 Ø 25 - **3824** Ø 55

3804.660	LED	1W	110 lm	4000 K	60°
3804.670	LED	1W	98 lm	3000 K	60°

3824.660	LED	4W	370lm	4000 K	60°
3824.670	LED	4W	320lm	3000 K	60°

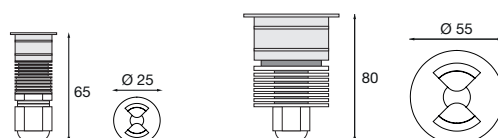

SCHEMI DI COLLEGAMENTO / SCHEMATICS

COLLEGAMENTO IN SERIE / SERIE CONNECTION : max 48Vdc SELV

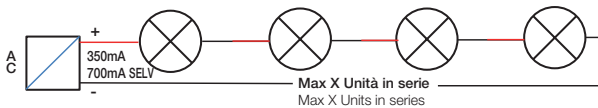

Max X Unità in serie
Max X Units in series

COLLEGAMENTO IN PARALLELO / PARALLEL CONNECTION - SELV

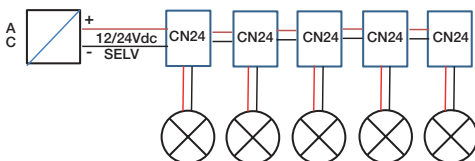

Il numero di unità dipende dalla potenza del driver impiegato e dalla lunghezza dei cavi / Unit nr. depends from power of driver and cables length

ALIMENTATORI IP20 / IP20 POWER SUPPLY

PIXEL MINI / PIXEL MINI

Cod. D 1 350 mA 1...12 apparecchi / 1...12 luminaires

PIXEL BIG / PIXEL BIG

Cod. D 2 700 mA 1...3 apparecchi / 1...3 luminaires

PIXEL MINI / PIXEL MINI

Cod. D 8 350 mA 1...14 apparecchi / 1...14 luminaires + **CN 24*** (per ogni faretto / each luminaire)

PIXEL BIG / PIXEL BIG

Cod. D 10 700 mA 1...4 apparecchi / 1...4 luminaires + **CN 24*** (per ogni faretto / each luminaire)

(*) **CN 24** va regolato secondo il manuale di istruzioni.
CN 24 must be set. Refer to CN24 instruction manual for setting.

OCEAN

Apparecchio da incasso a terra o a parete per esterni e interni costituito da:

- Corpo in acciaio inox AISI 316L o in resina acetica
- Vetro temperato o lente
- Cavo in neoprene L 500 mm
- Guarnizioni in silicone
- Cassaforma in ABS

Outdoor and indoor recessed ground or wall luminaire constructed of:

- Stainless steel AISI 316L or acetal resin frame
- Tempered glass or lens
- Neoprene cable L 500 mm
- Silicon gasket
- ABS holder

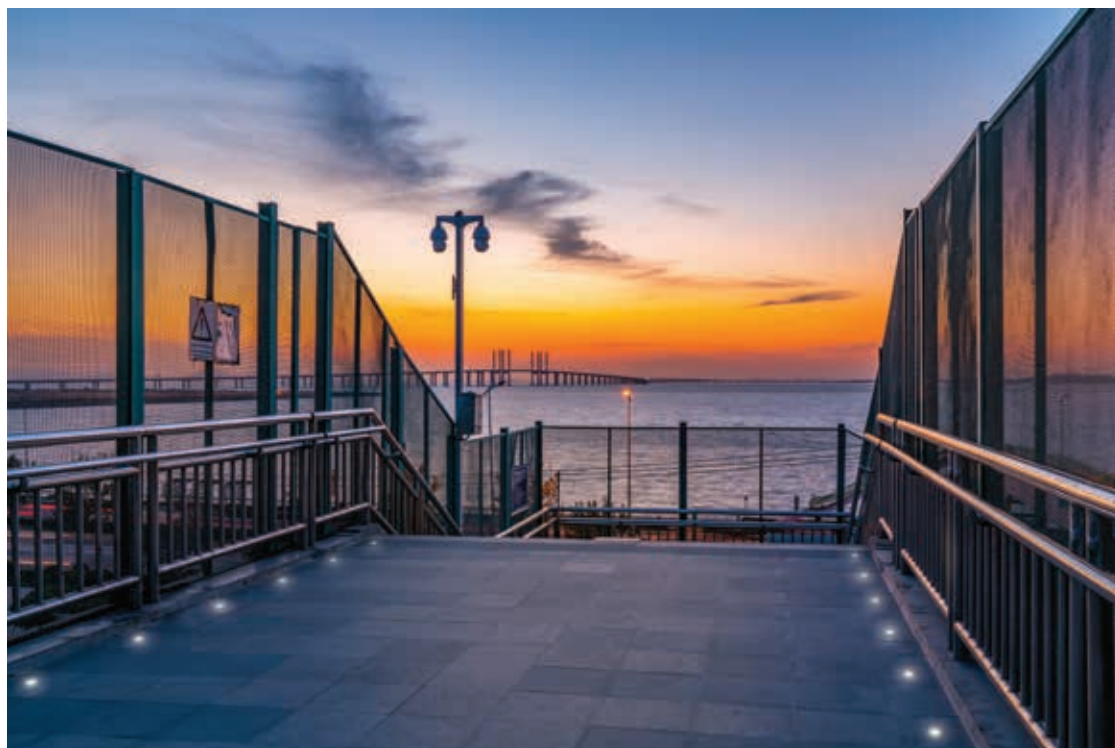

Gli apparecchi vengono forniti completi di cassaforma

The holder is enclosed with the luminaire



Incasso a parete
Recessed wall version



Incasso a terra
Recessed ground version

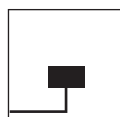

Entrata singola cavi di alimentazione
Single power supply cables input

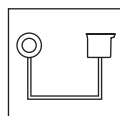

LED
L'apparecchio necessita di alimentatore remoto elettronico (fornito solo su richiesta)
The luminaire needs a remote power supply (supplied only on request)

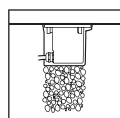

La cassaforma deve essere installata a filo terreno, prevedendo ghiaia di drenaggio per almeno 30 cm.
Ground luminaire. The box must be recessed into the ground providing a drainage-gravel for at least 30 cm



Apparecchio calpestabile
Walkable luminaire

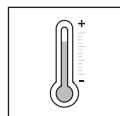

Temperatura di esercizio -40°C +50°C
Operating temperature -40°C +50°C



IK 10



cod. CS 05 per for art. 4305
cod. CS 04 per for art. 4304 - 4306
cod. CS 07 per for art. 4307
Cassaforma in ABS per incasso a terra
ABS holder for ground recessing



cod. CS 09 per for art. 4305
cod. CS 08 per for art. 4304 - 4306 - 4308
Cassaforma in PMMA per incasso a parete
PMMA holder for wall recessing



Simbolo che indica la temperatura delle superfici toccabili
Symbol indicating the temperature of the touchable surfaces

Temperatura superficie (ta 15°C)	Zona di installazione:
Surface temperature (ta 15°C)	Intended usage:
LED	2

NOTA: zona di installazione definita dalla norma EN 60598-2-13 Allegato A - Vedi pag. 348

Note: intended usage is defined by the standard EN 60598-2-13 Annex A - See pag. 348

NB
distanza tra driver e proiettore: max 20 mt.
Distance between driver and spotlight: max 20 mt.

Apparecchio da incasso a terra o a parete con ottica asimmetrica 45° (calpestabile).

Recessed ground or wall luminaire with 45° asymmetric optics (walkable)



4304 acciaio inox AISI 316L
AISI 316L stainless steel

4304.66X	LED	CRI85	3W	300 lm	4000 K	45°
-----------------	-----	-------	----	--------	--------	-----

4304.67X	LED	CRI85	3W	223 lm	2700 K	45°
-----------------	-----	-------	----	--------	--------	-----

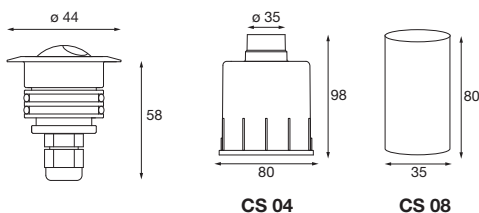

Alimentatore IP20 IP20 power supply

cod. A04

cod. Apparecchio	mA	n. max LED
4304 3W	700	10

Apparecchio da incasso a terra o a parete con ottica 110° (calpestabile).

Recessed ground or wall luminaire with 110° optics (walkable)

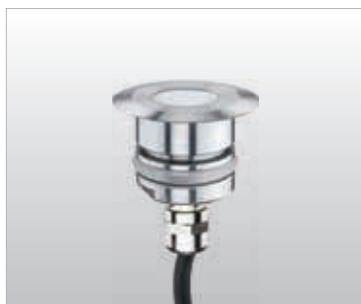

4305 acciaio inox AISI 316L
AISI 316L stainless steel

4305.66X	LED	CRI85	0,5W	12V DC	16 lm	4000 K	110°
-----------------	-----	-------	------	--------	-------	--------	------

4305.67X	LED	CRI85	0,5W	12V DC	13 lm	2700 K	110°
-----------------	-----	-------	------	--------	-------	--------	------

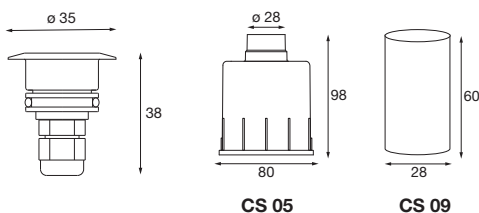

Alimentatore IP20 12V DC IP20 12V DC power supply

cod. A03

cod. Apparecchio	n. max LED
4305 0,5W	12V DC 10

Alimentatore IP20 12V DC IP20 12V DC power supply

cod. A05

cod. Apparecchio	n. max LED
4305 0,5W	12V DC 50

LED SMD collegati in parallelo.

Questo particolare tipo di LED ci permette di cablare gli apparecchi in parallelo potendo realizzare dei gruppi di accensione con numerosi LED.

LED SMD connected in parallel.

This particular LED allows cabling the appliances in parallel, offering the possibility to create switching units with numerous LEDs.

Apparecchio segnapasso da incasso a terra o a parete con calotta anti abbagliamento 70° (calpestabile).
 Recessed ground or wall steplight with 70° anti glare cover (walkable)



4306 acciaio inox AISI 316L
 AISI 316L stainless steel

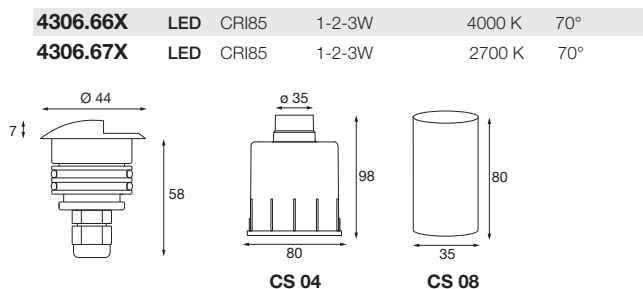

Alimentatore multipotenza IP20 IP20 multi-power supply
Cod. A06

Cod. Apparecchio	mA	n. max LED	lm
4306 1W	350	14	120
4306 2W	500	10	240
4306 3W	700	10	320

Apparecchio orientabile da incasso a terra disponibile con ottica 10°, 45° (calpestabile).
 Recessed ground adjustable luminaire with 10°, 45° optics (walkable)



4307 acciaio inox AISI 316L
 AISI 316L stainless steel

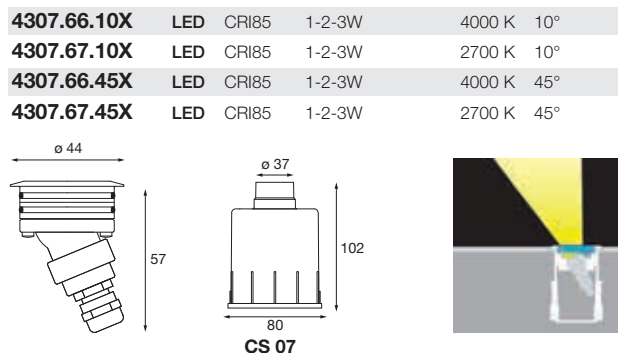

Alimentatore multipotenza IP20 IP20 multi-power supply
Cod. A06

Cod. Apparecchio	mA	n. max LED	lm
4307 1W	350	14	120
4307 2W	500	10	240
4307 3W	700	10	320

Apparecchio da incasso a parete 70°.
70° recessed wall luminaire.



4308 resina acetica
acetal resin

4308.66X	LED	CRI85	3W	320 lm	4000 K	70°
4308.67X	LED	CRI85	3W	300 lm	2700 K	70°

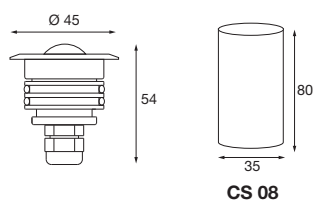

Alimentatore IP20 IP20 power supply

cod. A04

cod. Apparecchio	mA	n. max LED
4308 3W	700	10

DROP

Apparecchio da incasso a soffitto per esterni e interni costituito da:

- Art. 4301 corpo in alluminio e anello in acciaio inox AISI 316L
- Art. 4302 corpo in resina acetale
- Mollette di fissaggio in acciaio inox
- Lente piana satinata
- Cavo in neoprene L 500 mm
- Guarnizioni in silicone
- Cassaforma in ABS

Outdoor and indoor recessed ceiling luminaire constructed of:

- Art. 4301 Aluminium body and AISI 316L stainless steel ring
- Art. 4302 acetal resin body
- Satin flat lens
- Satinless steel fixing springs
- Neoprene cable L 500 mm
- Silicon gasket
- ABS holder

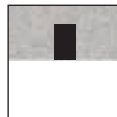

Incasso a soffitto
Recessed ceiling version

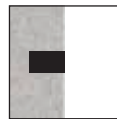

Incasso a parete
Recessed wall version

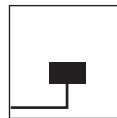

Entrata singola cavi di alimentazione
Single power supply cables input

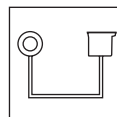

LED
L'apparecchio necessita di alimentatore remoto elettronico (fornito solo su richiesta)
The luminaire needs a remote power supply (supplied only on request)

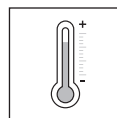

Temperatura di esercizio -40°C +50°C
Operating temperature -40°C +50°C



IK 10

Apparecchio da incasso a soffitto disponibile con ottica 10°, 45°.
Recessed ceiling luminaire with 10°, 45° optics.



4301

4301.66.10X	LED	CRI80	1-2-3W	4000 K	10°
4301.67.10X	LED	CRI80	1-2-3W	2700 K	10°
4301.66.45X	LED	CRI80	1-2-3W	4000 K	45°
4301.67.45X	LED	CRI80	1-2-3W	2700 K	45°

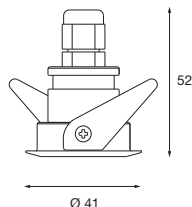

Alimentatore multipotenza IP20 Multi-power supply IP20
cod. A01

cod. Apparecchio	mA	n. max LED	lm
4301 1W	350	14	110
4301 2W	500	10	150
4301 3W	700	10	220

Apparecchio da incasso a soffitto 70°.
70° recessed ceiling luminaire.



4302 resina acetica
acetal resin

4302.66X	LED	CRI80	3W	223 lm	4000 K	70°
4302.67X	LED	CRI80	3W	195 lm	2700 K	70°

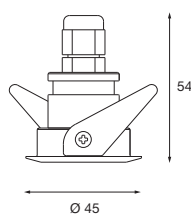

Alimentatore IP20 Power supply IP20
cod. A02

cod. Apparecchio	mA	n. max LED
4302 3W	700	10





OCEAN SPOT



GLAM

OCEAN SPOT

Proiettore per esterni ed interni
con gruppo ottico orientabile
costituito da:

- Corpo in acciaio inox AISI 316L
- Staffa di fissaggio in acciaio inox AISI 304
- Vetro temperato
- Ottica 10°, 45°, 90°
- Cavo in neoprene L 500 mm
- Guarnizioni in silicone
- Picchetto in acciaio inox AISI 304

Outdoor and indoor spotlight
with adjustable optical group
constructed of:

- Stainless steel AISI 316L body
- Stainless steel AISI 304 fixing bracket
- Tempered glass
- 10°, 45°, 90° optics
- Neoprene cable L 500 mm
- Silicon gaskets
- Stainless steel AISI 304 spike

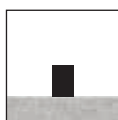

Installazione a terra
Floor mounting

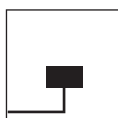

Entrata singola cavi di alimentazione
Single power supply cables input

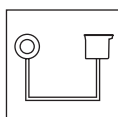

LED
L'apparecchio necessita di alimentatore remoto elettronico (fornito solo su richiesta)
The luminaire needs a remote power supply (supplied only on request)

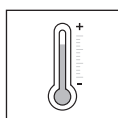

Temperatura di esercizio -40°C +50°C
Operating temperature -40°C +50°C



IK 10

ACCESSORIO
a richiesta / on request
art. PQ 51

Picchetto in acciaio inox AISI 304.
Stainless steel AISI 304 ground spike.

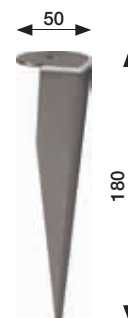

NB
distanza tra driver e proiettore: max 20 mt.
Distance between driver and spotlight: max 20 mt.

Disponibile in varie ottiche a 10°, 45°, 90°.
Available in various optics 10°, 45°, 90°.

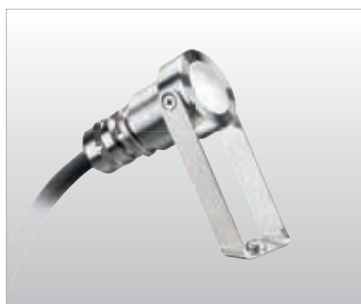

4310

4310.66.10X	LED	CRI85	3W	320 lm	4000 K	10°
4310.67.10X	LED	CRI85	3W	300 lm	2700 K	10°
4310.66.45X	LED	CRI85	3W	320 lm	4000 K	45°
4310.67.45X	LED	CRI85	3W	300 lm	2700 K	45°
4310.66.90X	LED	CRI85	3W	320 lm	4000 K	90°
4310.67.90X	LED	CRI85	3W	300 lm	2700 K	90°

cod. A10 driver 700 mA 31W max 12 LED IP20

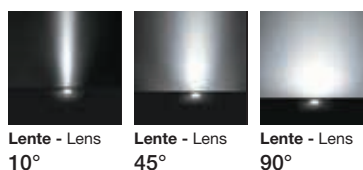
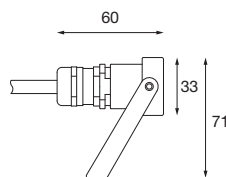

Disponibile con ottica 90°.
Available with 90° optic.



4311

4311.66.90X	LED	CRI85	5W	500 lm	4000 K	90°
4311.67.90X	LED	CRI85	5W	465 lm	2700 K	90°

cod. A11 driver 350 mA 27W max 4 LED IP20

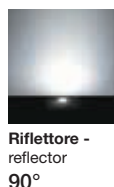
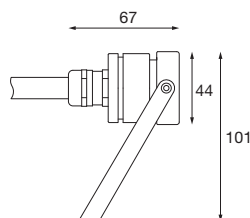

Disponibile in varie ottiche a 10°, 45°.
Available in various optics 10°, 45°.



4312

4312.66.10X	LED	CRI85	6W	730 lm	4000 K	10°
4312.67.10X	LED	CRI85	6W	670 lm	2700 K	10°
4312.66.45X	LED	CRI85	6W	730 lm	4000 K	45°
4312.67.45X	LED	CRI85	6W	670 lm	2700 K	45°

cod. A12 driver 500 mA 39W max 5 LED IP20

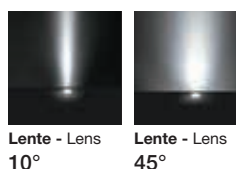
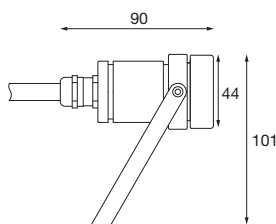

GLAM

Proiettore per interni ed esterni disponibile in due dimensioni BIG e MINI costituito da:

- Struttura in alluminio
- Ottica ibrida in policarbonato 24°, 38°
- Cavo in FEP + neoprene L 1000 mm
- Guarnizioni in silicone
- Viti di chiusura in acciaio inox
- Verniciatura in polveri poliesteri ad elevata resistenza ai raggi ultravioletti e alla corrosione

Indoor and outdoor spotlight available in two sizes BIG and MINI constructed of:

- Aluminium structure
- Polycarbonate hybrid lens 24°, 38°
- FEP + neoprene cable L 1000 mm
- Silicon gaskets
- Stainless steel screws
- Painting using high resistance to UV and corrosion polyester powders



Colori - Colours

X=3 Nero Black

X=4 Silver

Diffusore - Diffuser

Codice-Code 09 3850
09 3851



Installazione a parete
Wall mounting



Installazione a soffitto
Ceiling mounting

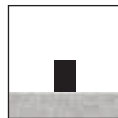

Installazione a terra
Floor mounting

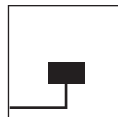

Entrata singola cavi di alimentazione
Single power supply cables input

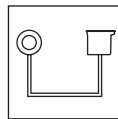

LED
L'apparecchio necessita di alimentatore remoto elettronico (fornito solo su richiesta)
The luminaire needs a remote power supply (supplied only on request)

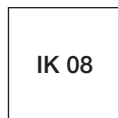

ACCESSORIO

art. PQ 50

Picchetto in acciaio inox AISI 304.
Stainless steel AISI 304 ground spike.

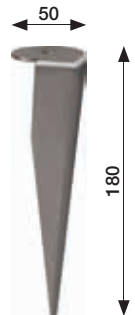

OPTIONAL

Per collegamento in parallelo
for parallel connection

art. CN 24

sistema di congiunzione IP67
con driver 350 mA / 500 mA / 700 mA
a 2 poli, 3 vie
per cavo Ø 4÷9,5 mm
IP67 connecting device
with driver 350 mA / 500 mA / 700 mA
with 2 poles, 3 ways
for cables Ø 4÷9,5 mm

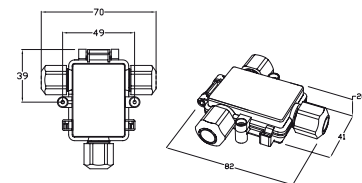

La base del proiettore GLAM può essere ruotata di 360° sul piano di montaggio al momento dell'installazione.

L'apparecchio è fornito di uno snodo che consente l'inclinazione manuale della testa di 90°.

The base of spotlight GLAM can be rotated 360° on the assembly surface during installation.

The appliance is equipped with swivel that allows 90° manual tilt of the head.

GLAM è disponibile in varie ottiche a 24°, 38°.

GLAM is available in various optics 24°, 38°.



3851 MINI

GLAM MINI

3851.66.24X	LED	CRI80	5,4W	24V	520 lm	4000 K	24°
3851.67.24X	LED	CRI90	5,4W	24V	500 lm	3000 K	24°
3851.66.38X	LED	CRI80	5,4W	24V	520 lm	4000 K	38°
3851.67.38X	LED	CRI90	5,4W	24V	500 lm	3000 K	38°



3850 BIG

GLAM BIG

3850.66.24X	LED	CRI80	8,4W	24V	1120 lm	4000 K	24°
3850.67.24X	LED	CRI90	8,4W	24V	1060 lm	3000 K	24°
3850.66.38X	LED	CRI80	8,4W	24V	1120 lm	4000 K	38°
3850.67.38X	LED	CRI90	8,4W	24V	1060 lm	3000 K	38°

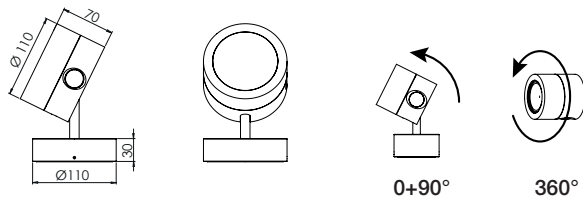

SCHEMI DI COLLEGAMENTO / SCHEMATICS

COLLEGAMENTO IN SERIE/ SERIE CONNECTION : max 48Vdc SELV

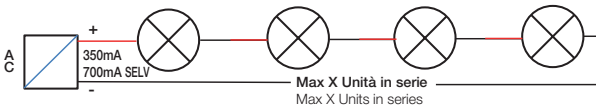

ALIMENTATORI IP20 / IP20 POWER SUPPLY

GLAM MINI / GLAM MINI

Cod. D 51 350 mA 1...3 apparecchi / 1...3 luminaires

GLAM BIG / GLAM BIG

Cod. D 50 700 mA 1...2 apparecchi / 1...2 luminaires

COLLEGAMENTO IN PARALLELO / PARALLEL CONNECTION - SELV

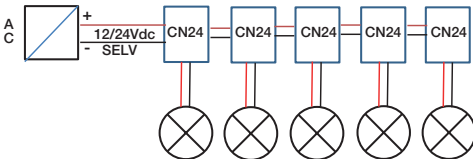

GLAM MINI / GLAM MINI

Cod. D 31 350 mA 1...3 apparecchi / 1...3 luminaires + CN 24* (per ogni faretto / each luminaire)

GLAM BIG / GLAM BIG

Cod. D 30 700 mA 1...4 apparecchi / 1...4 luminaires + CN 24* (per ogni faretto / each luminaire)

(*) CN 24 va regolato secondo il manuale di istruzioni.
CN 24 must be set. Refer to CN24 instruction manual for setting.

Il numero di unità dipende dalla potenza del driver impiegato e dalla lunghezza dei cavi / Unit nr. depends from power of driver and cables length

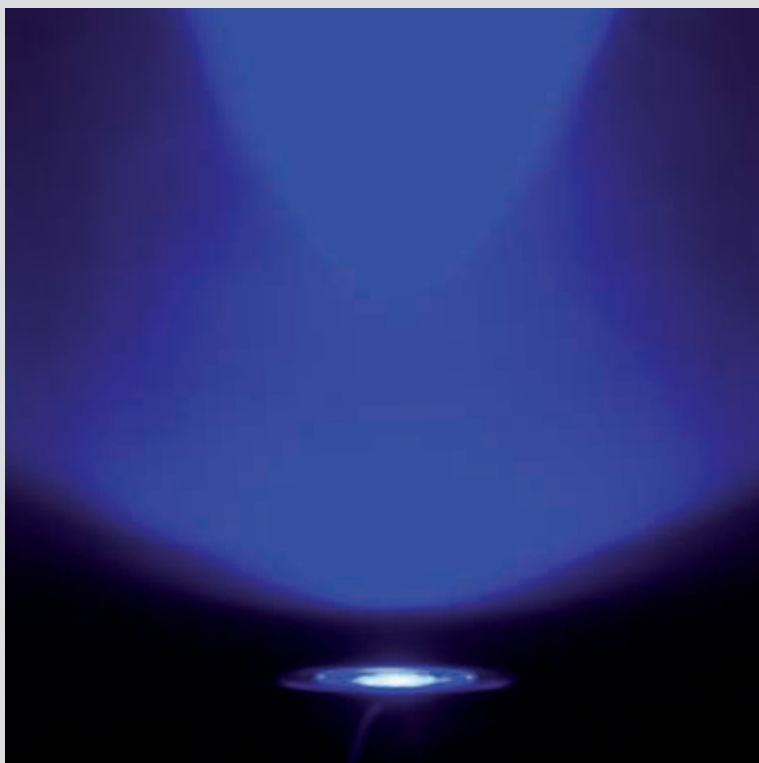



Ø 67



Ø 120



Ø 163



Ø 220



Ø 245



Ø 275



Ø 310

GEO

MICRO GEO

Apparecchio da incasso a terra per esterni ed interni costituito da:

- Corpo in alluminio pressofuso verniciato
- Anello frontale in acciaio inox AISI 316L
- Diffusore in vetro satinato temperato
- Guarnizione in silicone
- Viti di chiusura in acciaio inox
- Cassaforma in tecnopolimero
- Verniciatura in polveri poliestere ad elevata resistenza ai raggi ultravioletti e alla corrosione

Outdoor and indoor recessed ground luminaire constructed of:

- Painted die-cast aluminium body
- Stainless steel AISI 316L ring
- Satin tempered glass diffuser
- Silicon gasket
- Stainless steel screws
- Technopolymer holder
- Painting using high resistance to UV and corrosion polyester powders



Diffusore - Diffuser
Codice-Code 00 5094

Gli apparecchi vengono forniti completi di cassaforma
The holder is enclosed with the luminaire



Incasso a terra
Recessed ground version

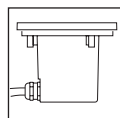

Entrata singola cavi di alimentazione con pressacavi PG 7 (Ø 3,5÷7 mm). Usare cavi flessibili. (Cavi rigidi possono compromettere la tenuta stagna IP67).
Single power supply entry cable with PG 7 (Ø 3,5÷7 mm) cable glands. Use flexible cables (rigid cables may compromise IP67 rating)

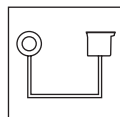

LED
L'apparecchio necessita di alimentatore remoto elettronico (non incluso)
The luminaire needs a remote power supply (not included)

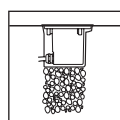

La cassaforma deve essere installata a filo terreno, prevedendo ghiaia di drenaggio per almeno 30 cm.
Ground luminaire. The box must be recessed into the ground providing a drainage-gravel for at least 30 cm

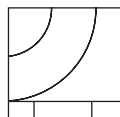

Carico massimo:
Kg 2000 a velocità max 5 Km/h
Maximum load:
Kgs 2000 at 5 Km/h max speed



IK 09



cod. CS 74
Cassaforma in tecnopolimero per vano ad incasso h 95 mm - 117x86 mm - Ø 64 mm
Technopolymer holder h 95 mm - 117x86 mm Ø 64 mm



Simbolo che indica la temperatura delle superfici toccabili
Symbol indicating the temperature of the touchable surfaces

Temperatura superficie (ta 15°C) Surface temperature (ta 15°C)	Zona di installazione: Intended usage:
LED  <40°C	3

NOTA: zona di installazione definita dalla norma EN 60598-2-13 Allegato A - Vedi pag. 348
Note: intended usage is defined by the standard EN 60598-2-13 Annex A - See pag. 348



5094

Apparecchio da incasso a terra

Ground recessed luminaire

- **5094.010** LED max 1,3W 24V 210 lm 4000 K
- **5094.020** LED max 1,3W 24V 210 lm 3000 K

- **Con alimentatore remoto (fornito solo su richiesta)**
Remote power supply (supplied on request)

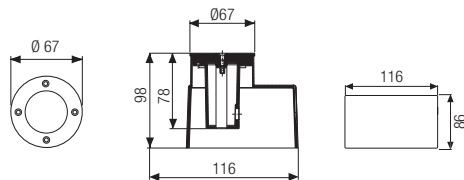

GEO Ø120

Apparecchio da incasso a terra, per esterni costituito da:

- Corpo in alluminio pressofuso verniciato
- Anello frontale in acciaio inox AISI 316L
- Diffusore in vetro satinato temperato
- Guarnizione in silicone
- Viti di chiusura in acciaio inox
- Cassaforma in tecnopolimero
- Verniciatura in polveri poliestere ad elevata resistenza ai raggi ultravioletti e alla corrosione

Outdoor recessed ground luminaire constructed of:

- Painted die-cast aluminium body
- Stainless steel AISI 316L
- Satin tempered glass diffuser
- Silicon gasket
- Stainless steel screws
- Technopolymer holder
- Painting using high resistance to UV and corrosion polyester powders



Diffusore - Diffuser
Codice-Code 00 6010

Gli apparecchi vengono forniti completi di cassaforma
The holder is enclosed with the luminaire

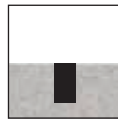

Incasso a terra
Recessed ground version

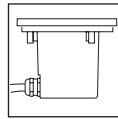

Entrata singola cavi di alimentazione con pressacavi M16 (Ø 5÷10 mm). Usare cavi flessibili. (Cavi rigidi possono compromettere la tenuta stagna IP67).
Single power supply entry cable with M16 cable glands. Use flexible cables (rigid cables may compromise IP67 rating)

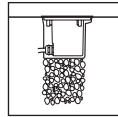

La cassaforma deve essere installata a filo terreno, prevedendo ghiaia di drenaggio per almeno 30 cm.
Ground luminaire. The holder must be recessed into the ground providing a drainage-gravel for at least 30 cm

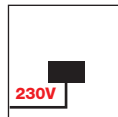

LED
Led a tensione di rete 220/240V 50/60Hz. Connessione diretta alla rete di alimentazione senza necessità di alimentatore.
LED's direct operation at 220/240V 50/60Hz. No power supply is required.

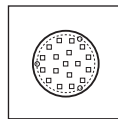

LED GX53
Non necessita di alcun alimentatore.
It does not need the power supply.



Lampadina LED GU10 IP20 dimmerabile
LED GU10 IP20 dimmable bulb

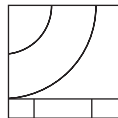

Carico massimo:
Kg 2000 a velocità max 5 Km/h
Maximum load:
Kgs 2000 at 5 Km/h max speed



IK 09



Simbolo che indica la temperatura delle superfici toccabili
Symbol indicating the temperature of the touchable surfaces

Temperatura superficie (ta 15°C)	Zona di installazione:
Surface temperature (ta 15°C)	Intended usage:
LED GX53	3
LED GU10	3
LED	3

NOTA: zona di installazione definita dalla norma EN 60598-2-13 Allegato A - Vedi pag. 348
Note: intended usage is defined by the standard EN 60598-2-13 Annex A - See pag. 348



5081

• 5081.680		LED	6,5W	GX53	650 lm	4000 K
• 5081.690		LED	6,5W	GX53	650 lm	3000 K
• 5081.050		LED GU10	4,9W		560 lm	4000 K
• 5081.060		LED GU10	4,9W		560 lm	3000 K
5081.660		LED	4W		510 lm	4000 K
5081.670		LED	4W		500 lm	3000 K

Anello in acciaio inox
Stainless steel ring

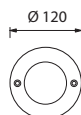

5082

• 5082.680		LED	6,5W	GX53	650 lm	4000 K
• 5082.690		LED	6,5W	GX53	650 lm	3000 K
• 5082.050		LED GU10	4,9W		560 lm	4000 K
• 5082.060		LED GU10	4,9W		560 lm	3000 K
5082.660		LED	4W		510 lm	4000 K
5082.670		LED	4W		500 lm	3000 K

Copertura in acciaio inox
Stainless steel cover

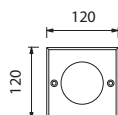

- L'apparecchio viene fornito completo di lampadina
Bulb enclosed with the luminaire



CS5087
(per/for LED GX53)
Cassaforma in tecnopolimero
per vano ad incasso
Ø 112/130 mm - h 103 mm
Technopolymer holder
to be recessed
Ø 112/130 mm - h 103 mm

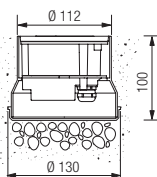

CS4010
(per/for LED 4W - LED GU10)
Cassaforma in tecnopolimero
per vano ad incasso
Ø 110 mm - h 100 mm
Technopolymer holder to be
recessed Ø 110 mm - h 100 mm

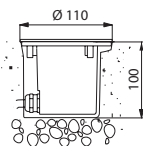

GEO Ø163

Apparecchio da incasso a terra per esterni costituito da:

- Struttura in alluminio pressofuso
- Anello frontale in acciaio inox AISI 316L o in alluminio pressofuso
- Diffusore in vetro trasparente
- Riflettore in alluminio
- Guarnizioni in silicone
- Viti di chiusura in acciaio inox
- Pozzetto in tecnopolimero
- Verniciatura in polveri poliestere ad elevata resistenza ai raggi ultravioletti e alla corrosione

Outdoor recessed ground luminaire constructed of:

- Painted die-cast aluminium structure
- Stainless steel AISI 316L or die-cast aluminium ring
- Transparent glass diffuser
- Aluminium reflector
- Silicon gaskets
- Stainless steel screws
- Technopolymer holder
- Painting using high resistance to UV and corrosion polyester powders



Colori - Colours Cod. 5090

X=9  Anthracite

X=4  Silver

Diffusore - Diffuser
Codice-Code 00 5090

Gli apparecchi vengono forniti completi di cassaforma
The holder is enclosed with the luminaire



Incasso a terra
Recessed ground version



cod. CS 91
Cassaforma in tecnopolimero
Technopolymer holder
Ø 158/123 mm - h 204 mm

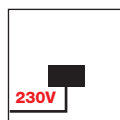



LED
L'apparecchio è fornito completo di alimentatore elettronico 220/240V 50/60Hz posizionato all'interno dell'apparecchio.
The luminaire is supplied with a 220/240V 50/60Hz built-in power supply.

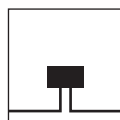

Simbolo che indica la temperatura delle superfici toccabili
Symbol indicating the temperature of the touchable surfaces



Entrata doppia cavi di alimentazione con presacavi M16 (Ø 5÷10 mm). Usare cavi flessibili. (Cavi rigidi possono compromettere la tenuta stagna IP67).
Double power supply entry cables with M16 cable glands. Use flexible cables (rigid cables may compromise IP67 rating).

Temperatura superficie (ta 15°C) Surface temperature (ta 15°C)	Zona di installazione: Intended usage:
LED PAR30  <50°C	3
LED  <50°C	3

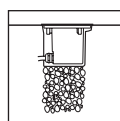

La cassaforma deve essere installata a filo terreno, prevedendo ghiaia di drenaggio per almeno 30 cm.
The holder must be recessed into the ground providing a drainage-gravel for at least 30 cm



Lampadina LED PAR30 IP65 dimmerabile
LED PAR30 IP65 dimmable bulb

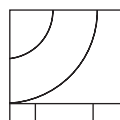

Carico massimo:
Kg 2000 a velocità max 5 Km/h
Maximum load:
Kgs 2000 at 5 Km/h max speed



NOTA: zona di installazione definita dalla norma EN 60598-2-13 Allegato A - Vedi pag. 348
Note: intended usage is defined by the standard EN 60598-2-13 Annex A - See pag. 348



5091.20 - 5091.21

LED disponibile in varie ottiche : 16°, 40°, 74°.
LED available in various optics : 16°, 40°, 74°.

Copertura in acciaio Inox AISI 316L
Stainless steel cover AISI 316L

5091.200	LED COB	13,7W	2070 lm	4000 K
5091.210	LED COB	13,7W	2000 lm	3000 K

Riflettore simmetrico - Symmetrical reflector

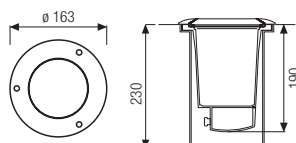

5091.05 - 5091.06

Copertura in acciaio INOX.
Stainless steel cover.

- **5091.050** LED PAR30 E27 9,5W 800 lm 4000 K 40°
- **5091.060** LED PAR30 E27 9,5W 800 lm 3000 K 40°

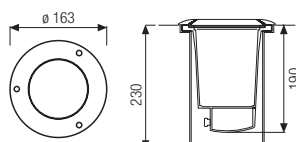

5090.20 - 5090.21

LED disponibile in varie ottiche : 16°, 40°, 74°.
LED available in various optics : 16°, 40°, 74°.

Copertura in acciaio Inox AISI 316L
Stainless steel cover AISI 316L

5090.20X	LED COB	13,7W	2070 lm	4000 K
5090.21X	LED COB	13,7W	2000 lm	3000 K

Riflettore simmetrico - Symmetrical reflector

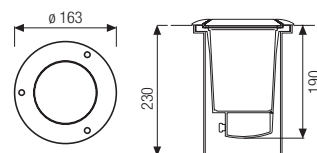

5090.05 - 5090.06

Copertura in alluminio pressofuso.
Die-cast aluminium cover.

- **5090.050** LED PAR30 E27 9,5W 800 lm 4000 K 40°
- **5090.060** LED PAR30 E27 9,5W 800 lm 3000 K 40°

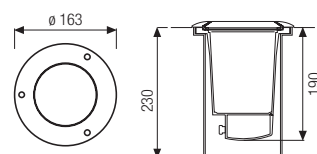

- **L'apparecchio viene fornito completo di lampadina**
Bulb enclosed with the luminaire

GEO Ø220

Apparecchio da incasso a terra per esterni costituito da:

- Struttura in alluminio pressofuso
- Anello frontale in acciaio inox AISI 316L o in alluminio pressofuso
- Diffusore in vetro trasparente o satinato
- Riflettore in alluminio
- Guarnizioni in silicone
- Viti di chiusura in acciaio inox
- Pozzetto in polipropilene
- Verniciatura in polveri poliestere ad elevata resistenza ai raggi ultravioletti e alla corrosione

Outdoor recessed ground luminaire constructed of:

- Painted die-cast aluminium structure
- Stainless steel AISI 316L or die-cast aluminium ring
- Transparent or satin glass diffuser
- Aluminium reflector
- Silicon gaskets
- Stainless steel screws
- Polypropylene holder
- Painting using high resistance to UV and corrosion polyester powders



CON ANELLO INOX

Diffusore trasparente: 00 2065

Diffusore satinato: 00 2060

With inox ring

Transparent diffuser: 00 2065

Satin diffuser: 00 2060

CON ANELLO ALLUMINIO

Diffusore trasparente: 00 3065

Diffusore satinato: 00 3060

With aluminium ring

Transparent diffuser: 00 3065

Satin diffuser: 00 3060

Gli apparecchi vengono forniti completi di cassaforma

The holder is enclosed with the luminaire



Incasso a terra
Recessed ground version

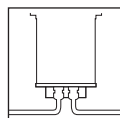

Doppia entrata cavi di alimentazione con presacavi PG13,5 (ø 6÷12 mm). Usare cavi flessibili per non compromettere la tenuta stagna IP67.
Double entrance of the supply cables with gland type PG 13,5(ø 6÷12 mm). Use only flexible cables to grant protection against water exposure (IP67)

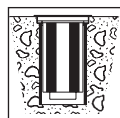

La cassaforma deve essere installata a filo terreno, prevedendo ghiaia di drenaggio per almeno 30 cm.
The holder must be recessed into the ground providing a drainage-gravel for at least 30 cm

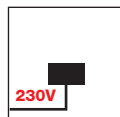

LED
L'apparecchio è fornito completo di alimentatore elettronico 220/240V 50/60Hz posizionato all'interno dell'apparecchio.
The luminaire is supplied with a 220/240V 50/60Hz built-in power supply.



Lampadina LED PAR30 IP65 dimmerabile
LED PAR30 IP65 dimmable bulb

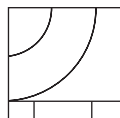

Carico massimo:
Kg 2000 a velocità max 5 Km/h
Maximum load:
Kgs 2000 at 5 Km/h max speed



IK 09



cod. CS 60
Pozzetto in polipropilene
Polypropylene holder
Ø 180 mm - h 250 mm



cod. CS 69
Pozzetto in polipropilene
Polypropylene holder
Ø 180 mm - h 230 mm



Simbolo che indica la temperatura delle superfici toccabili
Symbol indicating the temperature of the touchable surfaces

Temperatura superficie (ta 15°C)	Zona di installazione:
Surface temperature (ta 15°C)	Intended usage:
LED PAR30	3
LED	3

NOTA: zona di installazione definita dalla norma EN 60598-2-13 Allegato A - Vedi pag. 348

Note: intended usage is defined by the standard EN 60598-2-13 Annex A - See pag. 348

Anello frontale acciaio inox AISI 316L
AISI 316L stainless steel bezel

ANELLO INOX con sporgenza fuori terra inferiore a 5 mm
INOX RING with projection from the ground less than 5 mm

GEO Ø220

GEO Ø220

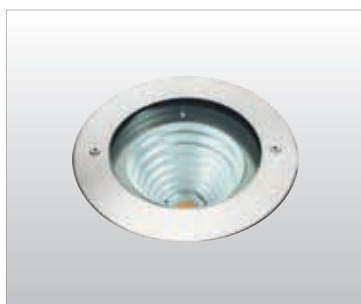

2065

Riflettore simmetrico
Symmetrical reflector

LED disponibile in varie ottiche : 29°, 46°, 72°.
LED available in various optics : 29°, 46°, 72°.

Vetro Trasparente - Transparent glass

2065.200	LED COB	17,5W	2900 lm	4000 K
2065.210	LED COB	17,5W	2890 lm	3000 K

Riflettore simmetrico - Symmetrical reflector

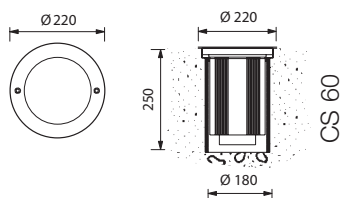

2069

Riflettore asimmetrico
Asymmetrical reflector

Vetro Trasparente - Transparent glass

2069.200	LED COB	17,5W	2900 lm	4000 K
2069.210	LED COB	17,5W	2890 lm	3000 K

Riflettore asimmetrico - Asymmetrical reflector

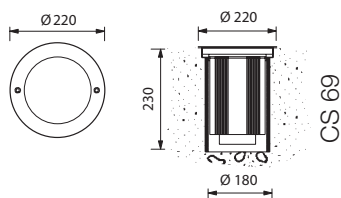

2060

Vetro Trasparente - Transparent glass

- **2060.050**  LED PAR30 9,5W E27 800 lm 4000 K 40°
- **2060.060**  LED PAR30 9,5W E27 800 lm 3000 K 40°

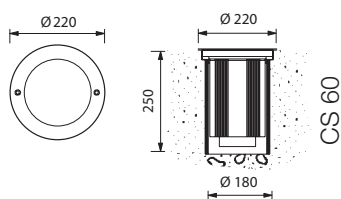

- **L'apparecchio viene fornito completo di lampadina**
Bulb enclosed with the luminaire



Anello frontale in alluminio
 pressofuso verniciato nero
 Die casted black frontal aluminium
 bezel

ANELLO ALLUMINIO perfettamente a filo pavimento
 (sporgenza 0 mm) in modo da non intralciare il camminamento
 Perfectly flush with the floor ALUMINIUM RING (projection 0 mm)
 as do not obstacle the walking

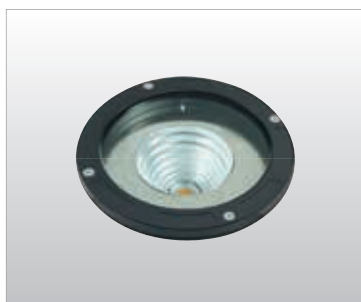

3065
 Riflettore simmetrico
 Symmetrical reflector

LED disponibile in varie ottiche : 29°, 46°, 72°.
 LED available in various optics : 29°, 46°, 72°.

Vetro Trasparente - Transparent glass

3065.203	LED COB	17,5W	2900 lm	4000 K
3065.213	LED COB	17,5W	2890 lm	3000 K

Riflettore simmetrico - Symmetrical reflector

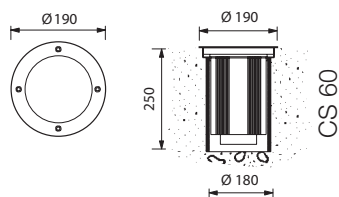

3069
 Riflettore asimmetrico
 Asymmetrical reflector

Vetro Trasparente - Transparent glass

3069.203	LED COB	17,5W	2900 lm	4000 K
3069.213	LED COB	17,5W	2890 lm	3000 K

Riflettore asimmetrico - Asymmetrical reflector

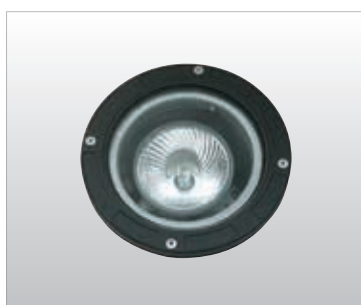
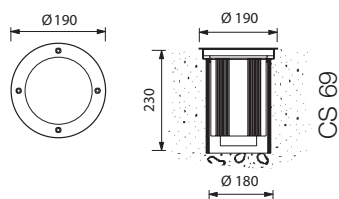

3060

Vetro Trasparente o satinato - Transparent or satin glass

- **3060.053** LED PAR30 9,5W E27 800 lm 4000 K 40°
- **3060.063** LED PAR30 9,5W E27 800 lm 3000 K 40°

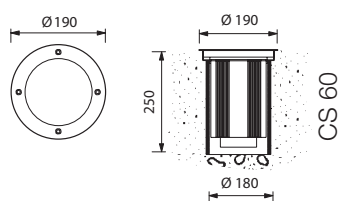

- L'apparecchio viene fornito completo di lampadina
 Bulb enclosed with the luminaire

GEO Ø245

Apparecchio da incasso a terra per esterni costituito da:

- Struttura in alluminio pressofuso
- Anello frontale in acciaio inox AISI 316L o in alluminio pressofuso
- Diffusore in vetro trasparente
- Riflettore in alluminio
- Guarnizioni in silicone
- Viti di chiusura in acciaio inox
- Cassaforma in tecnopolimero
- Verniciatura in polveri poliestere ad elevata resistenza ai raggi ultravioletti e alla corrosione

Outdoor recessed ground luminaire constructed of:

- Painted die-cast aluminium structure
- Stainless steel AISI 316L or die-cast aluminium ring
- Transparent glass diffuser
- Aluminium reflector
- Silicon gaskets
- Stainless steel screws
- Technopolymer holder
- Painting using high resistance to UV and corrosion polyester powders

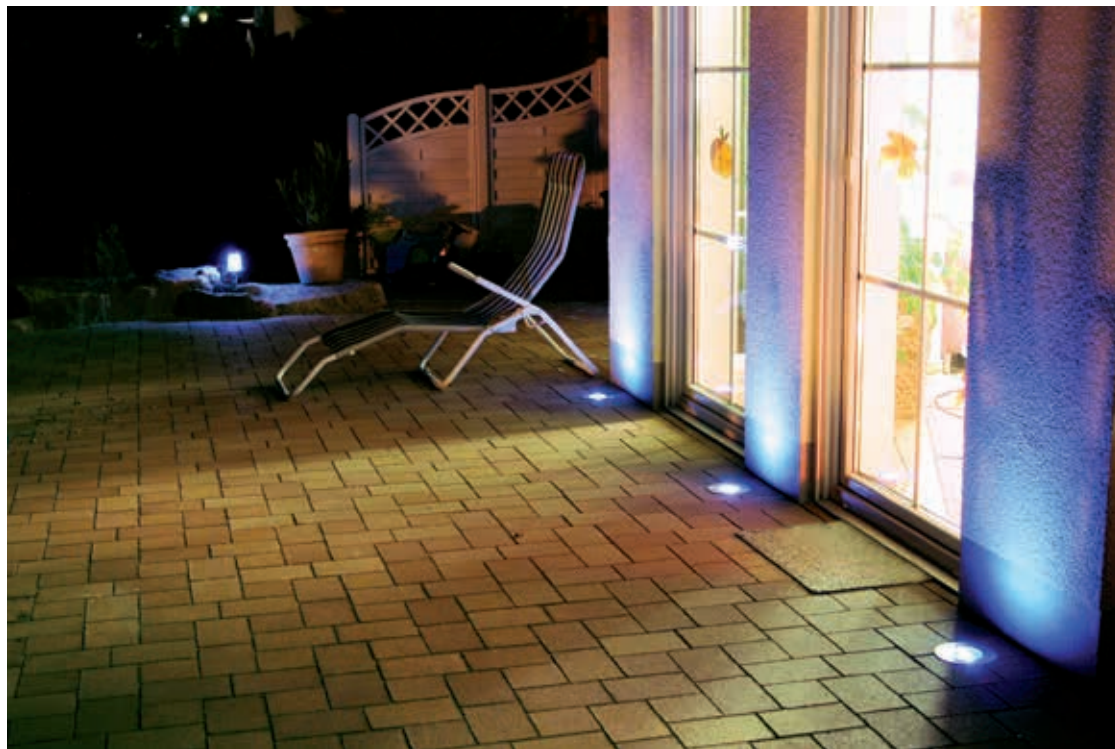

Colori - Colours Cod. 4470 - 4471

- X=3  Nero
Black
- X=4  Silver

Diffusore - Diffuser
Codice-Code 00 4270
00 4470

Gli apparecchi vengono forniti completi di cassaforma
The holder is enclosed with the luminaire



Incasso a terra
Recessed ground version

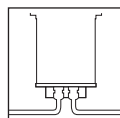

Doppia entrata cavi di alimentazione con presacavi PG13,5 (ø 6÷12 mm). Usare cavi flessibili per non compromettere la tenuta stagna IP67.
Double entrance of the supply cables with gland type PG 13,5(ø 6÷12 mm). Use only flexible cables to grant protection against water exposure (IP67)

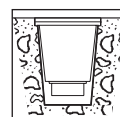

La cassaforma deve essere installata a filo terreno, prevedendo ghiaia di drenaggio per almeno 30 cm.
The holder must be recessed into the ground providing a drainage-gravel for at least 30 cm

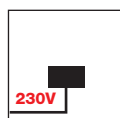

LED
L'apparecchio è fornito completo di alimentatore elettronico 220/240V 50/60Hz posizionato all'interno dell'apparecchio.
The luminaire is supplied with a 220/240V 50/60Hz built-in power supply.

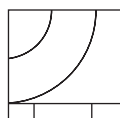

Carico massimo:
Kg 2000 a velocità max 5 Km/h
Maximum load:
Kgs 2000 at 5 Km/h max speed



IK 09



cod. CS 90
Cassaforma in tecnopolimero
Ø 230/180 mm - h 367 mm
technopolymer holder
Ø 230/180 mm - h 367 mm

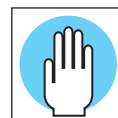

Simbolo che indica la temperatura delle superfici toccabili
Symbol indicating the temperature of the touchable surfaces

Temperatura superficie (ta 15°C) Surface temperature (ta 15°C)		Zona di installazione: Intended usage:
LED	 <50°C	3

NOTA: zona di installazione definita dalla norma EN 60598-2-13 Allegato A - Vedi pag. 348
Note: intended usage is defined by the standard EN 60598-2-13 Annex A - See pag. 348

Anello frontale acciaio inox AISI 316L
AISI 316L stainless steel bezel

ANELLO INOX con sporgenza fuori terra inferiore a 5 mm
INOX RING with projection from the ground less than 5 mm

GEO Ø245

GEO Ø245

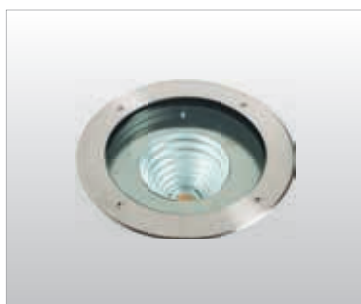

4270
Riflettore simmetrico
Symmetrical reflector

LED disponibile in varie ottiche : 29°, 46°, 72°.
LED available in various optics : 29°, 46°, 72°.

4270.200	LED COB	23,3W	3820 lm	4000 K
4270.210	LED COB	23,3W	3800 lm	3000 K

Riflettore simmetrico - Symmetrical reflector

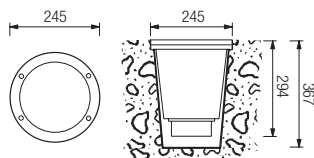

4271
Riflettore asimmetrico
Asymmetrical reflector

4271.200	LED COB	23,3W	3820 lm	4000 K
4271.210	LED COB	23,3W	3800 lm	3000 K

Riflettore asimmetrico - Asymmetrical reflector

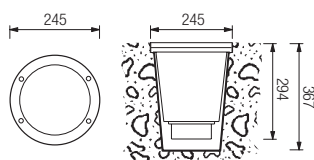

Anello frontale in alluminio pressofuso verniciato nero o silver - Black or silver die-cast aluminium bezel

ANELLO ALLUMINIO perfettamente a filo pavimento (sporgenza 0 mm)
in modo da non intralciare il camminamento

Perfectly flush with the floor ALUMINIUM RING (projection 0 mm)
as do not obstacle the walking



4470
Riflettore simmetrico
Symmetrical reflector

LED disponibile in varie ottiche : 29°, 46°, 72°.
LED available in various optics : 29°, 46°, 72°.

4470.20X	LED COB	23,3W	3820 lm	4000 K
4470.21X	LED COB	23,3W	3800 lm	3000 K

Riflettore simmetrico - Symmetrical reflector

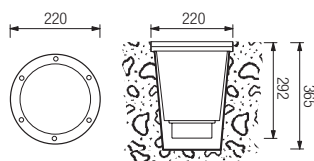

4471
Riflettore asimmetrico
Asymmetrical reflector

4471.20X	LED COB	23,3W	3820 lm	4000 K
4471.21X	LED COB	23,3W	3800 lm	3000 K

Riflettore asimmetrico - Asymmetrical reflector

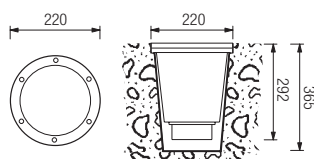

GEO Ø275

Apparecchio da incasso a terra per esterni costituito da:

- Struttura in alluminio pressofuso
- Anello frontale in acciaio inox AISI 316L o in alluminio
- Diffusore in vetro trasparente o satinato
- Riflettore in alluminio
- Guarnizioni in silicone
- Viti di chiusura in acciaio inox
- Cassaforma in tecnopolimero
- Verniciatura in polveri poliestere ad elevata resistenza ai raggi ultravioletti e alla corrosione

Outdoor recessed ground luminaire constructed of:

- Painted die-cast aluminium structure
- Stainless steel AISI 316L or aluminium ring
- Transparent or satin glass diffuser
- Aluminium reflector
- Silicon gaskets
- Stainless steel screws
- Technopolymer holder
- Painting using high resistance to UV and corrosion polyester powders



Diffusore - Diffuser

Codice-Code 00 1070 per/for Cod. 1070 - 1071

Codice-Code 00 2070 per/for Cod. 2070 - 2071

Gli apparecchi vengono forniti completi di cassaforma
The holder is enclosed with the luminaire

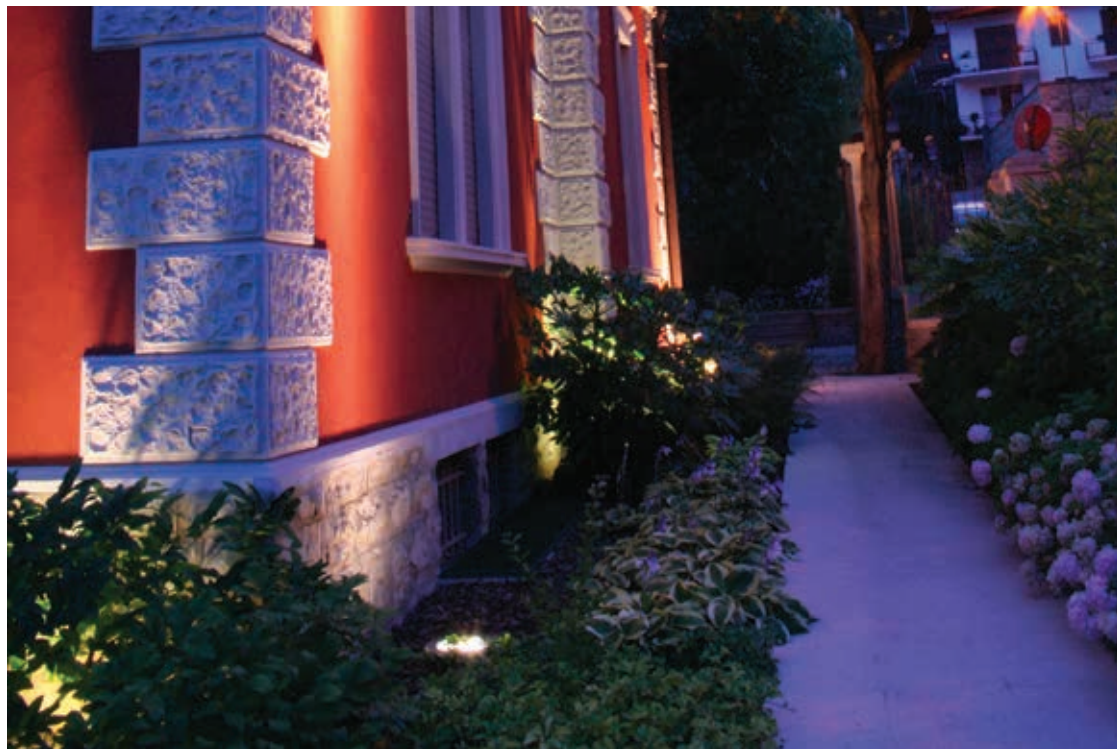

Incasso a terra
Recessed ground version

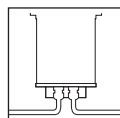

Doppia entrata cavi di alimentazione con presacavi PG13,5 (ø 6÷12 mm). Usare cavi flessibili per non compromettere la tenuta stagna IP67
Double entrance of the supply cables with gland type PG 13,5(ø 6÷12 mm). Use only flexible cables to grant protection against water exposure (IP67)

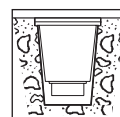

La cassaforma deve essere installata a filo terreno, prevedendo ghiaia di drenaggio per almeno 30 cm
The holder must be recessed into the ground providing a drainage-gravel for at least 30 cm

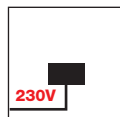

LED
L'apparecchio è fornito completo di alimentatore elettronico 220/240V 50/60Hz posizionato all'interno dell'apparecchio.
The luminaire is supplied with a 220/240V 50/60Hz built-in power supply.

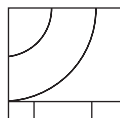

Carico massimo:
Kg 2000 a velocità max 5 Km/h
Maximum load:
Kgs 2000 at 5 Km/h max speed



IK 09



cod. CS 90
Cassaforma in tecnopolimero
Ø 255/190 mm - h 350 mm
technopolymer holder
Ø 255/190 mm - h 350 mm



Simbolo che indica la temperatura delle superfici toccabili
Symbol indicating the temperature of the touchable surfaces

Temperatura superficie (ta 15°C)		Zona di installazione:
Surface temperature	(ta 15°C)	Intended usage:
LED	<60°C	3

NOTA: zona di installazione definita dalla norma EN 60598-2-13 Allegato A - Vedi pag. 348
Note: intended usage is defined by the standard EN 60598-2-13 Annex A - See pag. 348

Anello frontale acciaio inox AISI 316L
AISI 316L stainless steel bezel

ANELLO INOX con sporgenza fuori terra inferiore a 5 mm
INOX RING with projection from the ground less than 5 mm

GEO Ø275

GEO Ø275

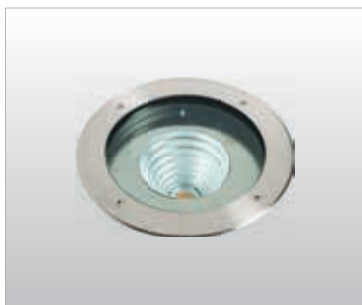

1070
Riflettore simmetrico
Symmetrical reflector

LED disponibile in varie ottiche : 29°, 46°, 72°.
LED available in various optics : 29°, 46°, 72°.

Vetro Trasparente - Transparent glass

1070.200	LED COB	23,3W	3820 lm	4000 K
1070.210	LED COB	23,3W	3800 lm	3000 K

Riflettore simmetrico - Symmetrical reflector

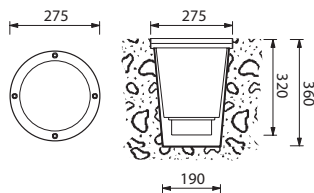

1071
Riflettore asimmetrico
Asymmetrical reflector

Vetro Trasparente - Transparent glass

1071.200	LED COB	23,3W	3820 lm	4000 K
1071.210	LED COB	23,3W	3800 lm	3000 K

Riflettore asimmetrico - Asymmetrical reflector

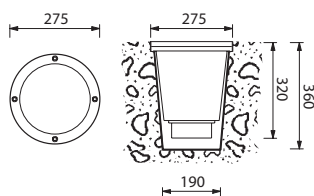

Anello frontale in alluminio pressofuso verniciato nero - Black die-cast aluminium bezel

ANELLO ALLUMINIO perfettamente a filo pavimento (sporgenza 0 mm)
in modo da non intralciare il camminamento

Perfectly flush with the floor ALUMINIUM RING (projection 0 mm)
as do not obstacle the walking



2070
Riflettore simmetrico
Symmetrical reflector

LED disponibile in varie ottiche : 29°, 46°, 72°.
LED available in various optics : 29°, 46°, 72°.

Vetro Trasparente - Transparent glass

2070.203	LED COB	23,3W	3820 lm	4000 K
2070.213	LED COB	23,3W	3800 lm	3000 K

Riflettore simmetrico - Symmetrical reflector

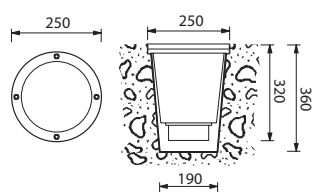

2071
Riflettore asimmetrico
Asymmetrical reflector

Vetro Trasparente - Transparent glass

2071.203	LED COB	23,3W	3820 lm	4000 K
2071.213	LED COB	23,3W	3800 lm	3000 K

Riflettore asimmetrico - Asymmetrical reflector

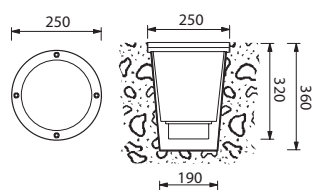

GEO Ø310

Apparecchio da incasso a terra per esterni costituito da:

- Struttura in alluminio pressofuso
- Anello frontale in acciaio inox AISI 316L
- Diffusore in vetro trasparente
- Riflettore in alluminio
- Guarnizioni in silicone
- Viti di chiusura in acciaio inox
- Cassaforma in tecnopolimero
- Verniciatura in polveri poliestere ad elevata resistenza ai raggi ultravioletti e alla corrosione

Outdoor recessed ground luminaire constructed of:

- Painted die-cast aluminium structure
- Stainless steel AISI 316L
- Transparent glass diffuser
- Aluminium reflector
- Silicon gaskets
- Stainless steel screws
- Technopolymer holder
- Painting using high resistance to UV and corrosion polyester powders



Diffusore - Diffuser
Codice-Code 00 1078

Gli apparecchi vengono forniti completi di cassaforma

The holder is enclosed with the luminaire



Incasso a terra
Recessed ground version

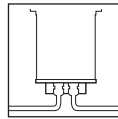

Doppia entrata cavi di alimentazione con presacavi PG13,5 (ø 6÷12 mm). Usare cavi flessibili per non compromettere la tenuta stagna IP67
Double entrance of the supply cables with gland type PG 13,5(ø 6÷12 mm). Use only flexible cables to grant protection against water exposure (IP67)

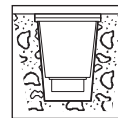

La cassaforma deve essere installata a filo terreno, prevedendo ghiaia di drenaggio per almeno 30 cm.
The holder must be recessed into the ground providing a drainage-gravel for at least 30 cm

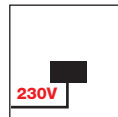

LED
L'apparecchio è fornito completo di alimentatore elettronico 220/240V 50/60Hz posizionato all'interno dell'apparecchio
The luminaire is supplied with a 220/240V 50/60Hz built-in power supply.

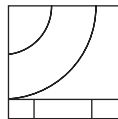

Carico massimo:
Kg 2000 a velocità max 5 Km/h
Maximum load:
Kgs 2000 at 5 Km/h max speed



IK 09



cod. CS 78
Cassaforma in tecnopolimero
Ø 290/230 mm - h 417 mm
Technopolymer holder
Ø 290/230 mm - h 417 mm

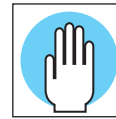

Simbolo che indica la temperatura delle superfici toccabili
Symbol indicating the temperature of the touchable surfaces

Temperatura superficie (ta 15°C)		Zona di installazione:
Surface temperature	(ta 15°C)	Intended usage:
LED	<60°C	3

NOTA: zona di installazione definita dalla norma EN 60598-2-13 Allegato A - Vedi pag. 348
Note: intended usage is defined by the standard EN 60598-2-13 Annex A - See pag. 348

Anello frontale acciaio inox AISI 316L
AISI 316L stainless steel bezel

ANELLO INOX con sporgenza fuori terra inferiore a 5 mm
INOX RING with projection from the ground less than 5 mm

GEO Ø310

GEO Ø310



1078

Riflettore simmetrico
Symmetrical reflector

LED disponibile in varie ottiche : 29°, 46°, 72°.
LED available in various optics : 29°, 46°, 72°.

1078.200	LED COB	35,8W	5670 lm	4000 K
1078.210	LED COB	35,8W	5650 lm	3000 K

Riflettore simmetrico - Symmetrical reflector

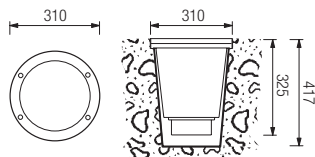

1079

Riflettore asimmetrico
Asymmetrical reflector

1079.200	LED COB	35,8W	5670 lm	4000 K
1079.210	LED COB	35,8W	5650 lm	3000 K

Riflettore asimmetrico - Asymmetrical reflector

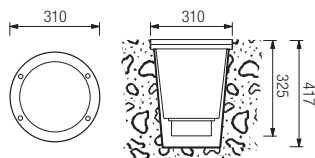





HELIOS



ADAS

HELIOS

Apparecchio da incasso
costituito da:

- Struttura in alluminio pressofuso
- Diffusore in policarbonato opale
- Parabola riflettente in alluminio
- Guarnizioni in silicone
- Viti di chiusura in acciaio inox
- Pozzetto in polipropilene
- Verniciatura in polveri poliestere ad elevata resistenza ai raggi ultravioletti e alla corrosione

Recessed luminaire
constructed of:

- Die-cast aluminium structure
- Opal polycarbonate diffuser
- Aluminium reflector
- Silicon gaskets
- Stainless steel screws
- Polypropylene holder
- Painting using high resistance to UV and corrosion polyester powders



IP67 INCASSO A TERRA
GROUND RECESSED

IP65 INCASSO A PARETE
WALL RECESSED

Colori - Colours

- X=3** Nero
Black
- X=9** Antracite
Anthracite

Diffusore - Diffuser
Codice-Code 08 1050

**Gli apparecchi vengono
forniti completi di cassaforma**

The holder is enclosed
with the luminaire



HELIOS art. 1050
Incasso a terra
Recessed ground version



HELIOS art. 1020-1022-1030-1032
Incasso a parete
Recessed wall version

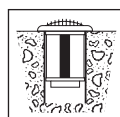

La cassaforma deve essere installata a filo terreno, prevedendo ghiaia di drenaggio per almeno 30 cm
The holder must be recessed into the ground providing a drainage-gravel for at least 30 cm

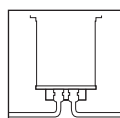

Doppia entrata cavi di alimentazione con presacavi PG13,5 (ø 6÷12 mm). Usare cavi flessibili per non compromettere la tenuta stagna IP67
Double entrance of the supply cables with gland type PG 13,5(ø 6÷12 mm). Use only flexible cables to grant protection against water exposure (IP67)

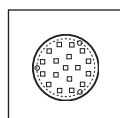

LED GX53
Non necessita di alcun alimentatore
It does not need the power supply



Lampadina LED PAR30 IP65 dimmerabile
LED PAR30 IP65 dimmable bulb

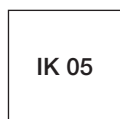

IK 05



cod. CS 51
per/for art. 1050.05/06
Pozzetto in polipropilene
Ø 180 mm - h 210 mm
Polypropylene holder
Ø 180 mm - h 210 mm



cod. CS 52
per/for art. 1050.68/69
Pozzetto in polipropilene
Ø 180 mm - h 120 mm
Polypropylene holder
Ø 180 mm - h 120 mm



cod. CS 20
per/for art. 1020 - 1022 - 1030 - 1032
Cassaforma in tecnopolimero da incassare nel muro prima dell'installazione della lampada Ø 185 mm - h 100 mm.
Non può essere installata a pavimento.
Technopolymer holder to be recessed into the wall before the installation of the luminaire Ø 185 mm - h 100 mm.
Not to be fitted as a buried uplighter.



Simbolo che indica la temperatura delle superfici toccabili
Symbol indicating the temperature of the touchable surfaces

Temperatura superficie (ta 15°C) Surface temperature (ta 15°C)	Zona di installazione: Intended usage:
LED <40°C	1

NOTA: zona di installazione definita dalla norma EN 60598-2-13 Allegato A - Vedi pag. 348
Note: intended usage is defined by the standard EN 60598-2-13 Annex A - See pag. 348

Apparecchio da incasso a terra non calpestabile e non carrabile.
 Not walkover and not driveover recessed ground luminaire.

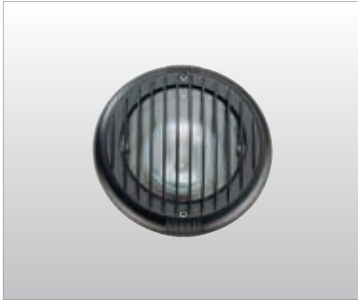

1050

- **1050.05X** LED PAR30 9,5W E27 800 lm 4000 K 40°
- **1050.06X** LED PAR30 9,5W E27 800 lm 3000 K 40°
- **1050.68X** LED 6,5W GX53 650 lm 4000 K
- **1050.69X** LED 6,5W GX53 650 lm 3000 K

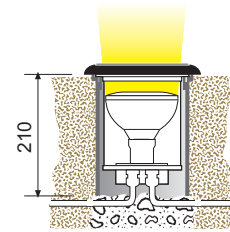
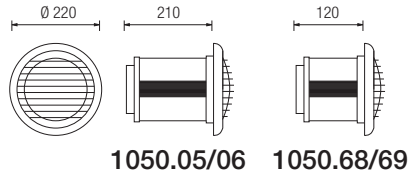

art. 1050.05/06

Apparecchio da incasso a parete.
 Recessed wall luminaire.

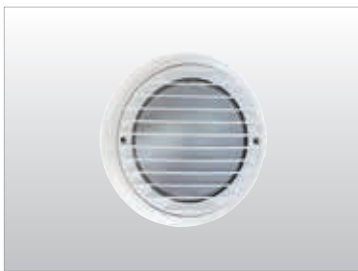

1030

- **1030.68X** LED 6,5W GX53 650 lm 4000 K
- **1030.69X** LED 6,5W GX53 650 lm 3000 K

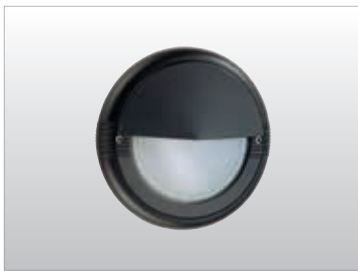
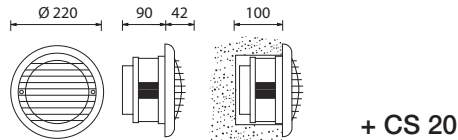

1032

- **1032.68X** LED 6,5W GX53 650 lm 4000 K
- **1032.69X** LED 6,5W GX53 650 lm 3000 K

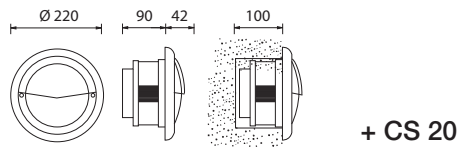

1020

- **1020.68X** LED 6,5W GX53 650 lm 4000 K
- **1020.69X** LED 6,5W GX53 650 lm 3000 K

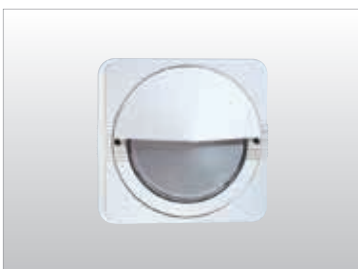
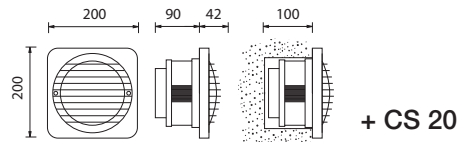

1022

- **1022.68X** LED 6,5W GX53 650 lm 4000 K
- **1022.69X** LED 6,5W GX53 650 lm 3000 K

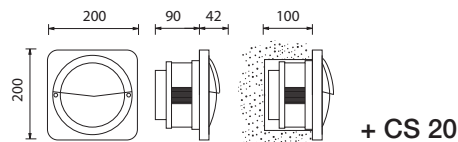

- L'apparecchio viene fornito completo di lampadina
 Bulb enclosed with the luminaire

ADAS

Apparecchio da incasso a parete e a terra costituito da:

- Struttura in alluminio pressofuso
- Copertura in acciaio inox satinato
- Diffusore in vetro temperato
- Parabola riflettente in alluminio
- Guarnizioni in silicone
- Viti di chiusura in acciaio inox
- Cassaforma in tecnopolimero per Cod. 1085
- Pozzetto in polipropilene per Cod. 1084
- Verniciatura in polveri poliestere ad elevata resistenza ai raggi ultravioletti e alla corrosione

Outdoor recessed wall or ground luminaire constructed of:

- Die-cast aluminium structure
- Satin stainless steel bezel
- Tempered glass diffuser
- Aluminium reflector
- Silicon gaskets
- Stainless steel screws
- Technopolymer holder for Code 1085
- Polypropylene holder for Code 1084
- Painting using high resistance to UV and corrosion polyester powders



Diffusore - Diffuser
Codice-Code 00 1085

Gli apparecchi vengono forniti completi di cassaforma
The holder is enclosed with the luminaire



Cod. 1084
Incasso a terra
Recessed ground version



Cod. 1085
Incasso a parete
Recessed wall version

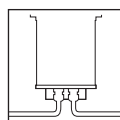

Doppia entrata cavi di alimentazione con presacavi PG13,5 (ø 6÷12 mm). Usare cavi flessibili per non compromettere la tenuta stagna IP67.
Double entrance of the supply cables with gland type PG 13,5(ø 6÷12 mm). Use only flexible cables to grant protection against water exposure (IP67)

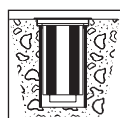

Versione terra. La cassaforma deve essere installata a filo terreno, prevedendo ghiaia di drenaggio per almeno 30 cm.
Recessed ground luminaire.
The holder must be recessed into the ground providing a drainage-gravel for at least 30 cm

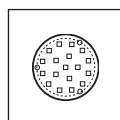

LED GX53
Non necessita di alcun alimentatore.
It does not need the power supply.



Lampadina LED PAR30 IP65 dimmerabile
LED PAR30 IP65 dimmable bulb



Apparecchio calpestabile max 1000 Kg
Walkable luminaire max 1000 Kgs



cod. CS 84
per/for art. 1084.05/06
Pozzetto in polipropilene
Ø 180 mm - h 210 mm
Polypropylene holder
Ø 180 mm - h 210 mm



cod. CS 83
per/for art. 1084.68/69
Pozzetto in polipropilene
Ø 180 mm - h 120 mm
Polypropylene holder
Ø 180 mm - h 130 mm



cod. CS 85
per/for art. 1085
Cassaforma in tecnopolimero da incassare a filo muro prima dell'installazione della lampada
Ø 185 mm - h. 130 mm.
Non può essere installata a pavimento.
Technopolymer holder to be recessed into the wall before the installation of the luminaire
Ø 185 mm - h. 130 mm.
Not to be fitted as a buried uplighter.

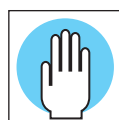

Simbolo che indica la temperatura delle superfici toccabili
Symbol indicating the temperature of the touchable surfaces

Temperatura superficie (ta 15°C)	Zona di installazione:
Surface temperature (ta 15°C)	Intended usage:
LED	2

NOTA: zona di installazione definita dalla norma EN 60598-2-13 Allegato A - Vedi pag. 348
Note: intended usage is defined by the standard EN 60598-2-13 Annex A - See pag. 348



1085

Apparecchio da incasso a parete

Recessed wall luminaire

- **1085.680**  LED 6,5W GX53 650 lm 4000 K
- **1085.690**  LED 6,5W GX53 650 lm 3000 K

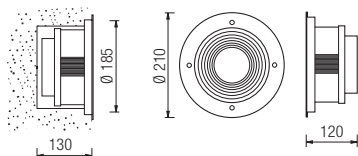

1084

Apparecchio da incasso a terra

Ground recessed luminaire

- **1084.050**  LED PAR30 9,5W E27 800 lm 4000 K 40°
- **1084.060**  LED PAR30 9,5W E27 800 lm 3000 K 40°

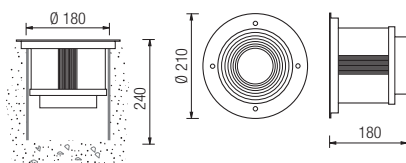

Apparecchio da incasso a terra

Ground recessed luminaire

- **1084.680**  LED 6,5W GX53 650 lm 4000 K
- **1084.690**  LED 6,5W GX53 650 lm 3000 K

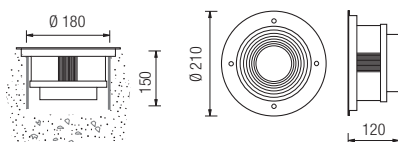

- **L'apparecchio viene fornito completo di lampadina**
Bulb enclosed with the luminaire



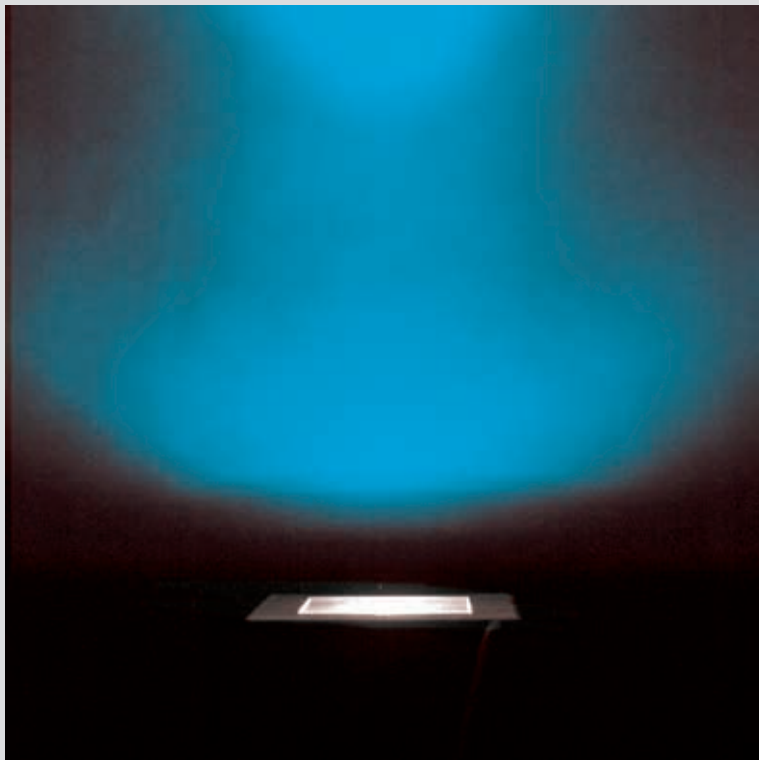



QUAD

MICRO QUAD

Apparecchio da incasso a terra e a parete per esterni ed interni costituito da:

- Corpo in alluminio pressofuso verniciato
- Anello frontale in acciaio inox AISI 316L
- Diffusore in vetro satinato temperato
- Guarnizione in silicone
- Viti di chiusura in acciaio inox
- Cassaforma in tecnopolimero
- Verniciatura in polveri poliestere ad elevata resistenza ai raggi ultravioletti e alla corrosione

Outdoor and indoor recessed ground and wall luminaire constructed of:

- Painted die-cast aluminium body
- Stainless steel AISI 316L ring
- Satin tempered glass diffuser
- Silicon gasket
- Stainless steel screws
- Technopolymer holder
- Painting using high resistance to UV and corrosion polyester powders



Diffusore - Diffuser
Codice-Code 00 5074

Gli apparecchi vengono forniti completi di cassaforma
The holder is enclosed with the luminaire



Incasso a terra
Recessed ground version

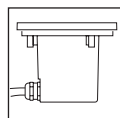

Entrata singola cavi di alimentazione con presacavi PG 7 (Ø 3,5÷7 mm). Usare cavi flessibili. (Cavi rigidi possono compromettere la tenuta stagna IP67).
Single power supply entry cable with PG 7 (Ø 3,5÷7 mm) cable glands. Use flexible cables (rigid cables may compromise IP67 rating)

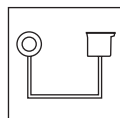

LED
L'apparecchio necessita di alimentatore remoto elettronico.
The luminaire needs a remote power supply.

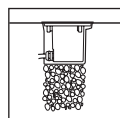

La cassaforma deve essere installata a filo terreno, prevedendo ghiaia di drenaggio per almeno 30 cm.
Ground luminaire. The holder must be recessed into the ground providing a drainage-gravel for at least 30 cm

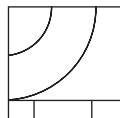

Carico massimo:
Kg 2000 a velocità max 5 Km/h
Maximum load:
Kgs 2000 at 5 Km/h max speed



IK 09



cod. CS 44
Cassaforma in tecnopolimero per vano ad incasso h 94 mm - 114 x 85 mm - □ 64 mm
Technopolymer holder to be recessed h 94 mm - 114 x 85 mm - □ 64 mm



Simbolo che indica la temperatura delle superfici toccabili
Symbol indicating the temperature of the touchable surfaces

Temperatura superficie (ta 15°C) Surface temperature (ta 15°C)	Zona di installazione: Intended usage:
LED	3

NOTA: zona di installazione definita dalla norma EN 60598-2-13 Allegato A - Vedi pag. 348
Note: intended usage is defined by the standard EN 60598-2-13 Annex A - See pag. 348



5074

Apparecchio da incasso a terra

Ground recessed luminaire

- **5074.010** LED 1,3W 24V 210 lm 4000 K
- **5074.020** LED 1,3W 24V 210 lm 3000 K
- **Con alimentatore remoto (fornito solo su richiesta)**
Remote power supply (supplied on request)

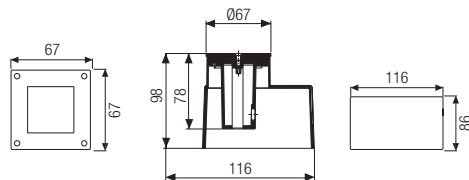

QUAD 125

Apparecchio da incasso a terra per interni ed esterni costituito da:

- Struttura in alluminio pressofuso verniciato
- Anello in acciaio inox AISI 316L o in alluminio pressofuso
- Diffusore in vetro satinato
- Riflettore in alluminio
- Guarnizioni in silicone
- Viti di chiusura in acciaio inox
- Cassaforma in tecnopolimero
- Verniciatura in polveri poliestere ad elevata resistenza ai raggi ultravioletti e alla corrosione

Outdoor and indoor recessed ground luminaire constructed of:

- Painted die-cast aluminium structure
- Stainless steel AISI 316L or die cast aluminium ring
- Satin glass diffuser
- Aluminium reflector
- Silicon gaskets
- Stainless steel screws
- Technopolymer holder
- Painting using high resistance to UV and corrosion polyester powders

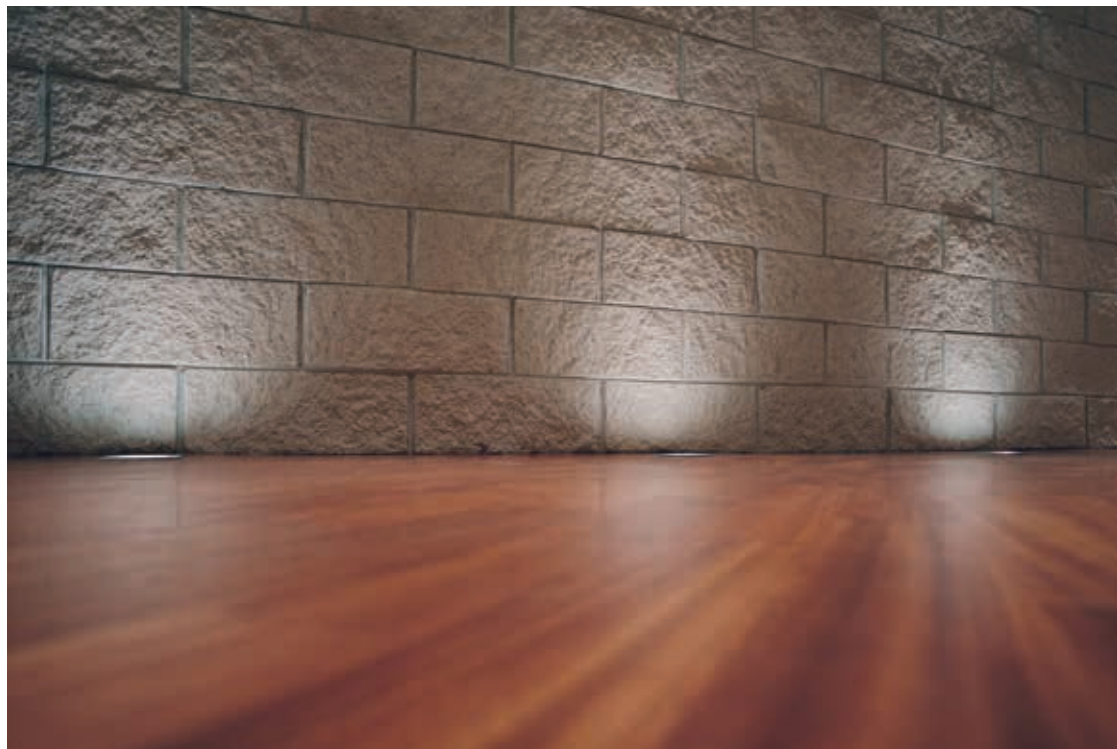

Colori - Colours per/for 5070

X=9  Antracite
Anthracite

X=4  Silver

Diffusore - Diffuser
Codice-Code 00 5070

Gli apparecchi vengono forniti completi di cassaforma
The holder is enclosed with the luminaire



Incasso a terra
Recessed ground version



cod. CS 72
Cassaforma in tecnopolimero
Technopolymer holder
☑ 118 mm - h 125 mm

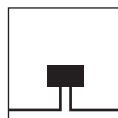

Doppia entrata cavi di alimentazione con pressacavi M16 (Ø 5÷10 mm). Usare cavi flessibili (cavi rigidi possono compromettere la tenuta stagna IP67).
Double power supply entry cable with M16 cable glands. Use flexible cables (rigid cables may compromise IP67 rating).



Simbolo che indica la temperatura delle superfici toccabili
Symbol indicating the temperature of the touchable surfaces

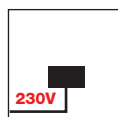

LED
Led a tensione di rete 220/240V 50/60Hz. Connessione diretta alla rete di alimentazione senza necessità di alimentatore.
LED's direct operation at 220/240V 50/60Hz. No power supply is required.

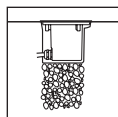

La cassaforma deve essere installata a filo terreno, prevedendo ghiaia di drenaggio per almeno 30 cm.
The holder must be recessed into the ground providing a drainage-gravel for at least 30 cm



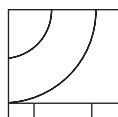

Lampadina LED GU10 IP20 dimmerabile
LED GU10 IP20 dimmable bulb

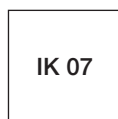

Carico massimo:
Kg 2000 a velocità max 5 Km/h
Maximum load:
Kgs 2000 at 5 Km/h max speed



IK 07

Temperatura superficie (ta 15°C)		Zona di installazione:
Surface temperature	(ta 15°C)	Intended usage:
LED GU10	 <40°C	3
LED	 <40°C	3

NOTA: zona di installazione definita dalla norma EN 60598-2-13 Allegato A - Vedi pag. 348
Note: intended usage is defined by the standard EN 60598-2-13 Annex A - See pag. 348



5072

Copertura in acciaio inox

Stainless steel cover

5072.660	LED	4W	510 lm	4000 K
5072.670	LED	4W	500 lm	3000 K
● 5072.050	LED GU10	4,9W	560 lm	4000 K
● 5072.060	LED GU10	4,9W	560 lm	3000 K

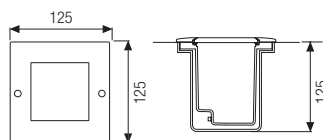

5070

Copertura in alluminio

Die-cast aluminium cover

5070.660	LED	4W	510 lm	4000 K
5070.670	LED	4W	500 lm	3000 K
● 5070.050	LED GU10	4,9W	560 lm	4000 K
● 5070.060	LED GU10	4,9W	560 lm	3000 K

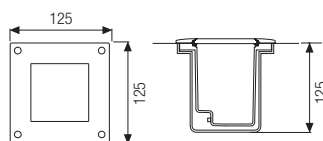

- **L'apparecchio viene fornito completo di lampadina**
Bulb enclosed with the luminaire

QUAD 163

Apparecchio da incasso a terra per esterni costituito da:

- Struttura in alluminio pressofuso
- Anello frontale in acciaio inox AISI 316L o in alluminio pressofuso
- Diffusore in vetro trasparente
- Riflettore in alluminio
- Guarnizioni in silicone
- Viti di chiusura in acciaio inox
- Pozzetto in tecnopolimero
- Verniciatura in polveri poliestere ad elevata resistenza ai raggi ultravioletti e alla corrosione

Outdoor recessed ground luminaire constructed of:

- Painted die-cast aluminium structure
- Stainless steel AISI 316L or die-cast aluminium ring
- Transparent glass diffuser
- Aluminium reflector
- Silicon gaskets
- Stainless steel screws
- Technopolymer holder
- Painting using high resistance to UV and corrosion polyester powders



Colori - Colours Cod. 5093

X=9  Antracite
Anthracite

X=4  Silver

Diffusore - Diffuser
Codice-Code 00 5092

Gli apparecchi vengono forniti completi di cassaforma

The holder is enclosed with the luminaire



Incasso a terra
Recessed ground version

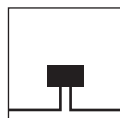

Doppia entrata cavi di alimentazione con presacavi M16 (Ø 5÷10 mm). Usare cavi flessibili. (Cavi rigidi possono compromettere la tenuta stagna IP67).
Double power supply entry cable with M16 cable glands. Use flexible cables (rigid cables may compromise IP67 rating)

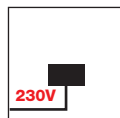

LED Cod. 5092.20/21 - 5093.20/21
L'apparecchio è fornito completo di alimentatore elettronico 220/240V 50/60Hz posizionato all'interno dell'apparecchio.
The luminaire is supplied with a 220/240V 50/60Hz built-in power supply.



Lampadina LED PAR30 IP65 dimmerabile
LED PAR30 IP65 dimmable bulb

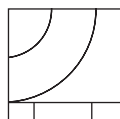

Carico massimo:
Kg 2000 a velocità max 5 Km/h
Maximum load:
Kgs 2000 at 5 Km/h max speed

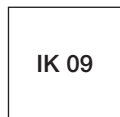



IK 09



cod. CS 92
Cassaforma in tecnopolimero
Technopolymer holder
☑ 158 mm - h 203 mm



Simbolo che indica la temperatura delle superfici toccabili
Symbol indicating the temperature of the touchable surfaces

Temperatura superficie (ta 15°C) Surface temperature (ta 15°C)	Zona di installazione: Intended usage:
LED PAR30  <50°C	3
LED  <50°C	3

NOTA: zona di installazione definita dalla norma EN 60598-2-13 Allegato A - Vedi pag. 348
Note: intended usage is defined by the standard EN 60598-2-13 Annex A - See pag. 348



5092.20 - 5092.21

Copertura in acciaio Inox AISI 316L

Stainless steel cover AISI 316L

LED disponibile in varie ottiche :16°, 40°, 74°.

LED available in various optics : 16°, 40°, 74°.

5092.200	LED COB	16,4W	2400 lm	4000 K
5092.210	LED COB	16,4W	2320 lm	3000 K

Riflettore simmetrico - Symmetrical reflector

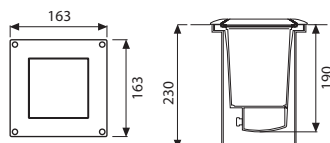

5092.05 - 5092.06

Copertura in acciaio Inox AISI 316L

Stainless steel cover AISI 316L

- **5092.050** LED PAR30 9,5W E27 800 lm 4000 K 40°
- **5092.060** LED PAR30 9,5W E27 800 lm 3000 K 40°

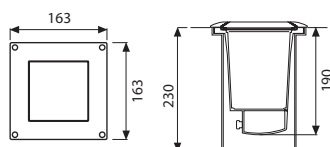

5093.20 - 5093.21

Copertura in alluminio pressofuso

Die-cast aluminium cover

LED disponibile in varie ottiche :16°, 40°, 74°.

LED available in various optics : 16°, 40°, 74°.

5093.20X	LED COB	16,4W	2400 lm	4000 K
5093.21X	LED COB	16,4W	2320 lm	3000 K

Riflettore simmetrico - Symmetrical reflector

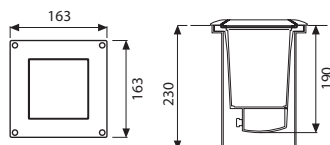

5093.05 - 5093.06

Copertura in alluminio pressofuso

Die-cast aluminium cover

- **5093.05X** LED PAR30 9,5W E27 800 lm 4000 K 40°
- **5093.06X** LED PAR30 9,5W E27 800 lm 3000 K 40°

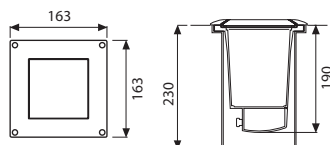

- L'apparecchio viene fornito completo di lampadina
Bulb enclosed with the luminaire

QUAD 200

Apparecchio da incasso a terra per esterni costituito da:

- Struttura in alluminio pressofuso
- Anello frontale in acciaio inox AISI 316L
- Diffusore in vetro trasparente
- Riflettore in alluminio
- Guarnizioni in silicone
- Viti di chiusura in acciaio inox
- Pozzetto in tecnopolimero
- Verniciatura in polveri poliestere ad elevata resistenza ai raggi ultravioletti e alla corrosione

Outdoor recessed ground luminaire constructed of:

- Painted die-cast aluminium structure
- Stainless steel AISI 316L ring
- Transparent glass diffuser
- Aluminium reflector
- Silicon gaskets
- Stainless steel screws
- Technopolymer holder
- Painting using high resistance to UV and corrosion polyester powders



Diffusore - Diffuser
Codice-Code 00 7230

Gli apparecchi vengono forniti completi di cassaforma

The holder is enclosed with the luminaire



Incasso a terra
Recessed ground version



cod. CS 95
Cassaforma in tecnopolimero
Technopolymer holder
220/250 mm - h 360 mm

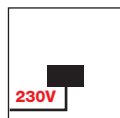

LED
L'apparecchio è fornito completo di alimentatore elettronico 220/240V 50/60Hz posizionato all'interno dell'apparecchio
The luminaire is supplied with a 220/240V 50/60Hz built-in power supply



Simbolo che indica la temperatura delle superfici toccabili
Symbol indicating the temperature of the touchable surfaces

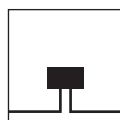

Entrata doppia cavi di alimentazione con pressacavi PG 13,5 (Ø 6÷12 mm). Usare cavi flessibili. (Cavi rigidi possono compromettere la tenuta stagna IP67)
Double power supply entry cables with PG 13,5 (Ø 6÷12 mm) cable glands. Use flexible cables (rigid cables may compromise IP67 rating)

Temperatura superficie (ta 15°C)		Zona di installazione:
Surface temperature	(ta 15°C)	Intended usage:
LED	<60°C	3

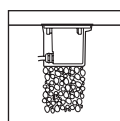

La cassaforma deve essere installata a filo terreno, prevedendo ghiaia di drenaggio per almeno 30 cm
Ground luminaire. The holder must be recessed into the ground providing a drainage-gravel for at least 30 cm

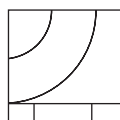

Carico massimo:
Kg 2000 a velocità max 5 Km/h
Maximum load:
Kgs 2000 at 5 Km/h max speed



NOTA: zona di installazione definita dalla norma EN 60598-2-13 Allegato A - Vedi pag. 348
Note: intended usage is defined by the standard EN 60598-2-13 Annex A - See pag. 348

Anello frontale acciaio inox AISI 316L
 AISI 316L stainless steel bezel

ANELLO INOX con sporgenza fuori terra inferiore a 5 mm
 INOX RING with projection from the ground less than 5 mm



7230
 Riflettore simmetrico
 Symmetrical reflector

LED disponibile in varie ottiche : 29°, 46°, 72°.
 LED available in various optics : 29°, 46°, 72°.

7230.200	LED COB	23,3W	3820 lm	4000 K
7230.210	LED COB	23,3W	3800 lm	3000 K

Riflettore simmetrico - Symmetrical reflector

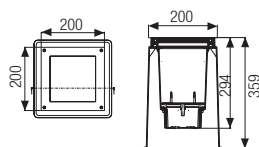

7231
 Riflettore asimmetrico
 Asymmetrical reflector

7231.200	LED COB	23,3W	3820 lm	4000 K
7231.210	LED COB	23,3W	3800 lm	3000 K

Riflettore asimmetrico - Asymmetrical reflector

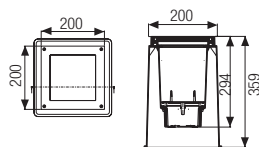

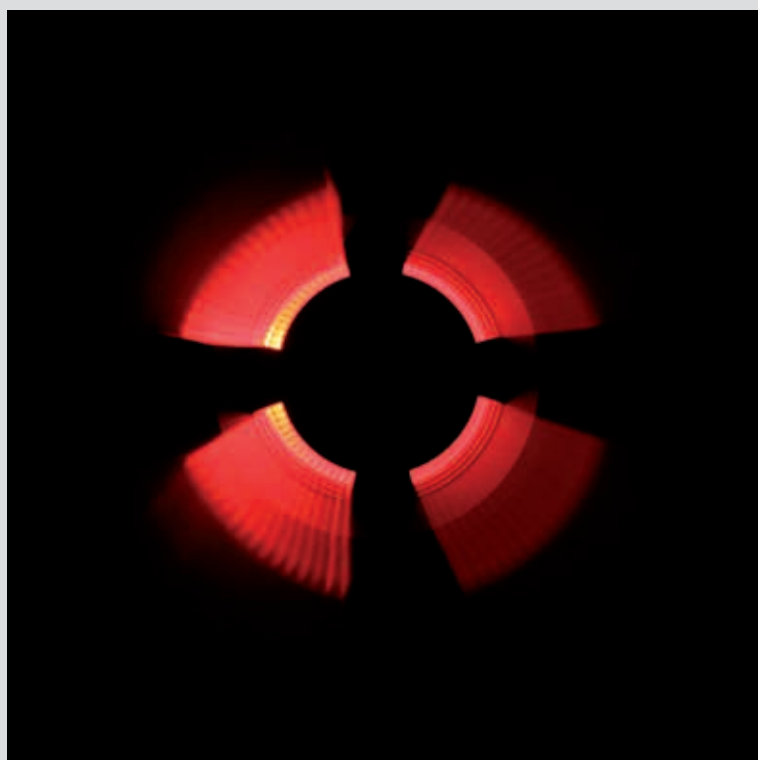



TREK



ZED

TREK MINI

Apparecchio da incasso a terra carrabile, per esterni costituito da:

- Corpo in alluminio pressofuso verniciato
- Diffusore in vetro satinato temperato
- Parabola riflettente in alluminio
- Guarnizione in silicone
- Viti di chiusura in acciaio inox
- Cassaforma in tecnopolimero
- Verniciatura in polveri poliestere ad elevata resistenza ai raggi ultravioletti e alla corrosione

Outdoor recessed driveover ground luminaire constructed of:

- Painted die-cast aluminium body
- Satin tempered glass diffuser
- Aluminium reflector
- Silicon gasket
- Stainless steel screws
- Technopolymer holder
- Painting using high resistance to UV and corrosion polyester powders



Colori - Colours

- X=3** Nero / Black
- X=9** Antracite / Anthracite
- X=4** Silver

Diffusore - Diffuser
Codice-Code 00 4011

Gli apparecchi vengono forniti completi di cassaforma
The holder is enclosed with the luminaire



Incasso a terra
Recessed ground version

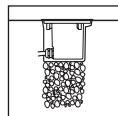

La cassaforma deve essere installata a filo terreno, prevedendo ghiaia di drenaggio per almeno 30 cm.
The holder must be recessed into the ground providing a drainage-gravel for at least 30 cm

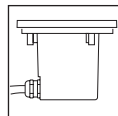

Entrata singola cavi di alimentazione con pressacavi M16 (Ø 5÷10 mm). Usare cavi flessibili. (Cavi rigidi possono compromettere la tenuta stagna IP67).
Single power supply entry cable with M16 cable glands. Use flexible cables (rigid cables may compromise IP67 rating)

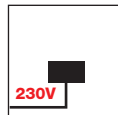

LED
Led a tensione di rete 220/240V 50/60Hz. Connessione diretta alla rete di alimentazione senza necessità di alimentatore.
LED's direct operation at 220/240V 50/60Hz. No power supply is required.

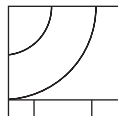

Carico massimo:
Kg 1500 a velocità max 5 Km/h
Maximum load:
Kgs 1500 at 5 Km/h max speed



IK 09



cod. CS 4010
Cassaforma in tecnopolimero per vano ad incasso Ø 110 mm - h 100 mm
Technopolymer holder to be recessed into the wall Ø 110 mm - h 100 mm

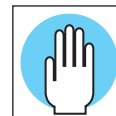

Simbolo che indica la temperatura delle superfici toccabili
Symbol indicating the temperature of the touchable surfaces

Temperatura superficie (ta 15°C)	Zona di installazione:
Surface temperature (ta 15°C)	Intended usage:
LED	3

NOTA: zona di installazione definita dalla norma EN 60598-2-13 Allegato A - Vedi pag. 348
Note: intended usage is defined by the standard EN 60598-2-13 Annex A - See pag. 348

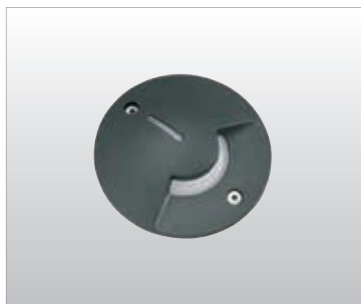

5015

5015.66X	LED	4W	510 lm	4000 K
5015.67X	LED	4W	500 lm	3000 K

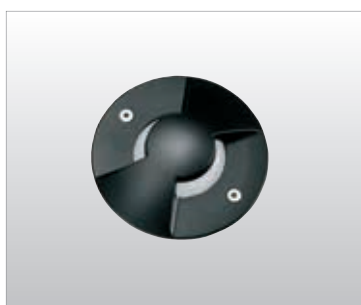
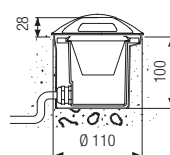
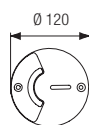
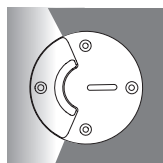

5014

5014.66X	LED	4W	510 lm	4000 K
5014.67X	LED	4W	500 lm	3000 K

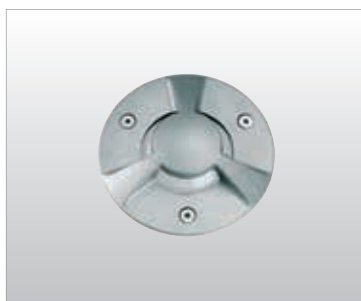
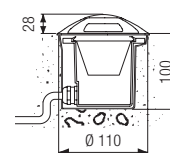
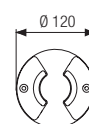
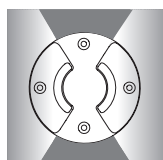

5016

5016.66X	LED	4W	510 lm	4000 K
5016.67X	LED	4W	500 lm	3000 K

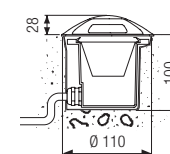
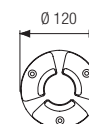
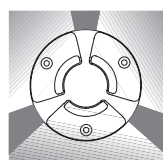

TREK BIG

Apparecchio da incasso a terra carrabile, per esterni costituito da:

- Corpo in alluminio pressofuso verniciato
- Diffusore in vetro trasparente temperato
- Parabola riflettente in alluminio
- Guarnizione in silicone
- Viti di chiusura in acciaio inox
- Cassaforma in polipropilene o in tecnopolimero
- Verniciatura in polveri poliesteri ad elevata resistenza ai raggi ultravioletti e alla corrosione

Outdoor recessed driveover ground luminaire constructed of:

- Painted die-cast aluminium body
- Transparent tempered glass diffuser
- Aluminium reflector
- Silicon gasket
- Stainless steel screws
- Polypropylene holder
- Painting using high resistance to UV and corrosion polyester powders



Colori - Colours

- X=3** Nero / Black
X=9 Antracite / Anthracite
X=4 Silver

Diffusore - Diffuser

Codice-Code **00 1050**
per/for Cod. 1045 - 1057

Codice-Code **00 5026**
per/for Cod. 5024 - 5025 - 5026

Gli apparecchi vengono forniti completi di cassaforma

The holder is enclosed with the luminaire



Incasso a terra
Recessed ground version

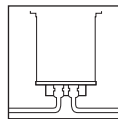

Doppia entrata cavi di alimentazione
Double entrance of the supply cables

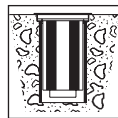

La cassaforma deve essere installata a filo terreno, prevedendo ghiaia di drenaggio per almeno 30 cm.
The holder must be recessed into the ground providing a drainage-gravel for at least 30 cm

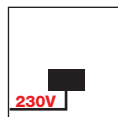

LED
L'apparecchio è fornito completo di alimentatore elettronico 220/240V 50/60Hz posizionato all'interno dell'apparecchio.
The luminaire is supplied with a 220/240V 50/60Hz built-in power supply.

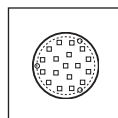

LED GX53
Non necessita di alcun alimentatore.
It does not need the power supply.



Lampadina LED PAR30 IP65 dimmerabile
LED PAR30 IP65 dimmable bulb

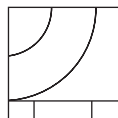

Carico massimo:
Kg 1500 a velocità max 5 Km/h
Maximum load:
Kgs 1500 at 5 Km/h max speed



IK 09

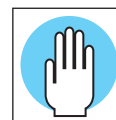

Simbolo che indica la temperatura delle superfici toccabili
Symbol indicating the temperature of the touchable surfaces

Temperatura superficie (ta 15°C)	Zona di installazione:
Surface temperature (ta 15°C)	Intended usage:
LED	3

NOTA: zona di installazione definita dalla norma EN 60598-2-13 Allegato A - Vedi pag. 348

Note: intended usage is defined by the standard EN 60598-2-13 Annex A - See pag. 348





5025

• 5025.68X		LED	6,5W	Gx53	650 lm	4000 K
• 5025.69X		LED	6,5W	Gx53	650 lm	3000 K
5025.25X		LED	6W		800 lm	4000 K
5025.26X		LED	6W		800 lm	3000 K

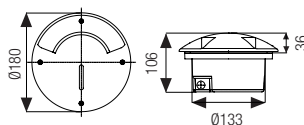
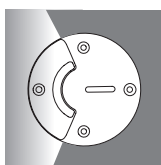

5024

• 5024.68X		LED	6,5W	Gx53	650 lm	4000 K
• 5024.69X		LED	6,5W	Gx53	650 lm	3000 K
5024.25X		LED	6W		800 lm	4000 K
5024.26X		LED	6W		800 lm	3000 K

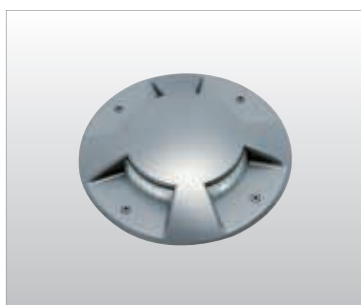
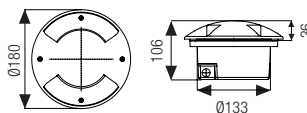
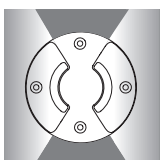

5026

• 5026.68X		LED	6,5W	Gx53	650 lm	4000 K
• 5026.69X		LED	6,5W	Gx53	650 lm	3000 K
5026.25X		LED	6W		800 lm	4000 K
5026.26X		LED	6W		800 lm	3000 K

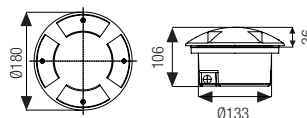

cod. CS 25
 Cassaforma in tecnopolimero per vano ad incasso
 Ø 170/186 mm - h 100 mm
 Technopolymer holder to be recessed into the wall
 Ø 170/186 mm - h 100 mm

- L'apparecchio viene fornito completo di lampadina
 Bulb enclosed with the luminaire





1057

- **1057.05X**  LED PAR30 9,5W E27 800 lm 4000 K 40°
- **1057.06X**  LED PAR30 9,5W E27 800 lm 3000 K 40°
- **1057.68X**  LED 6,5W Gx53 650 lm 4000 K
- **1057.69X**  LED 6,5W Gx53 650 lm 3000 K

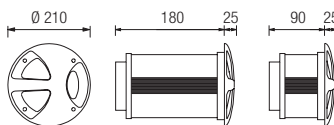
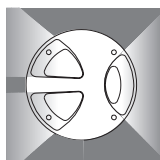

1057.05/06 1057.68/69



1045

- **1045.05X**  LED PAR30 9,5W E27 800 lm 4000 K 40°
- **1045.06X**  LED PAR30 9,5W E27 800 lm 3000 K 40°
- **1045.68X**  LED 6,5W Gx53 650 lm 4000 K
- **1045.69X**  LED 6,5W Gx53 650 lm 3000 K

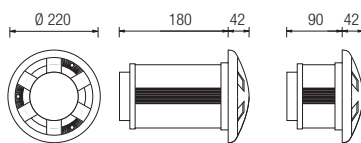
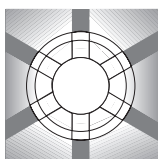

1045.05/06 1045.68/69



cod. CS 51
per/for art.
1057.05/06 e 1045.05/06
 Pozzetto in polipropilene
 Ø 180 mm - h 210 mm
 Polypropylene holder
 Ø 180 mm - h 210 mm



cod. CS 52
per/for art.
1057.68/69 - 1045.68/69
 Pozzetto in polipropilene
 Ø 180 mm - h 120 mm
 Polypropylene holder
 Ø 180 mm - h 120 mm

- L'apparecchio viene fornito completo di lampadina
 Bulb enclosed with the luminaire

ZED

Apparecchio da incasso a terra per illuminazione di esterni costituito da:

- Struttura in alluminio pressofuso verniciato
- Diffusore in vetro trasparente
- Guarnizioni in silicone
- Viti di chiusura in acciaio inox
- Pozzetto in polipropilene per installazione a terra
- Verniciatura in polveri poliestere ad elevata resistenza ai raggi ultravioletti e alla corrosione

Outdoor recessed ground luminaire constructed of:

- Painted die-cast aluminium body
- Transparent glass diffuser
- Silicon gaskets
- Stainless steel screws
- Polypropylene holder for ground fixing
- Painting using high resistance to UV and corrosion polyester powders



Colori - Colours

X=9  Antracite
Anthracite

X=4  Silver

Diffusore - Diffuser

Codice-Code 00 5054

Gli apparecchi vengono forniti completi di cassafornia
The holder is enclosed with the luminaire



Incasso a terra
Recessed ground version

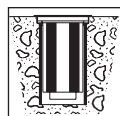

La cassafornia deve essere installata a filo terreno, prevedendo ghiaia di drenaggio per almeno 30 cm.

The holder must be recessed into the ground providing a drainage-gravel for at least 30 cm

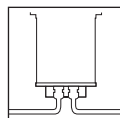

Doppia entrata cavi di alimentazione con pressacavi PG13,5 (ø 6÷12 mm). Usare cavi flessibili per non compromettere la tenuta stagna IP67.

Double entrance of the supply cables with gland type PG 13,5 (ø 6÷12 mm). Use only flexible cables to grant protection against water exposure (IP67)

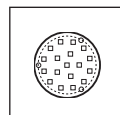

LED Gx53
Non necessita di alcun alimentatore.
It does not need the power supply.



cod. CS 52
Pozzetto in polipropilene
Ø 180 mm - h 150 mm
Polypropylene holder
Ø 180 mm - h 150 mm



Simbolo che indica la temperatura delle superfici toccabili
Symbol indicating the temperature of the touchable surfaces

Temperatura superficie (ta 15°C)		Zona di installazione:
Surface temperature	(ta 15°C)	Intended usage:
LED	 <40°C	1

NOTA: zona di installazione definita dalla norma EN 60598-2-13 Allegato A - Vedi pag. 348
Note: intended usage is defined by the standard EN 60598-2-13 Annex A - See pag. 348



5056 4 aperture / 4 openings

● 5056.68X		LED	6,5W	Gx53	650 lm	4000 K
● 5056.69X		LED	6,5W	Gx53	650 lm	3000 K

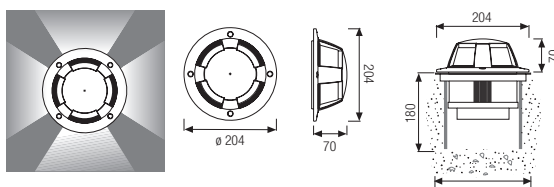

5054 2 aperture / 2 openings

● 5054.68X		LED	6,5W	Gx53	650 lm	4000 K
● 5054.69X		LED	6,5W	Gx53	650 lm	3000 K

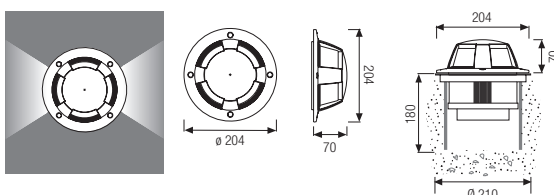

5058

● 5058.68X		LED	6,5W	Gx53	650 lm	4000 K
● 5058.69X		LED	6,5W	Gx53	650 lm	3000 K

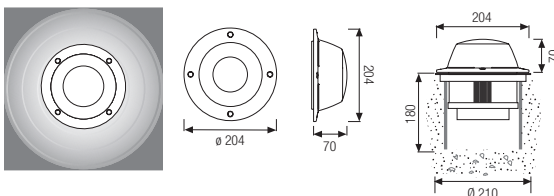

● L'apparecchio viene fornito completo di lampadina
Bulb enclosed with the luminaire





CLIC

CLIC

Apparecchio da incasso a parete per illuminazione di interni ed esterni costituito da:

- Struttura in alluminio pressofuso verniciato
- Art. 6012-6014 anello in acciaio inox AISI 316L
- Diffusore in vetro temperato
- Guarnizione in silicone
- Viti di chiusura in acciaio inox
- Cassaforma in tecnopolimero
- Verniciatura in polveri poliestere ad elevata resistenza ai raggi ultravioletti e alla corrosione

Indoor and outdoor recessed wall luminaire constructed of:

- Painted die-cast aluminium structure
- Art. 6012-6014 stainless steel AISI 316L ring
- Tempered glass diffuser
- Silicon gasket
- Stainless steel screws
- Technopolymer wall holder
- Painting using high resistance to UV and corrosion polyester powders



Colori - Colours

X=9  Antracite
Anthracite

X=4  Silver

Diffusore - Diffuser

Codice-Code **00 4010**
per/for Cod. 4012

Codice-Code **00 4011**
per/for Cod. 4011/4014

Codice-Code **00 6010**
per/for Cod. 6012 - 6014

Gli apparecchi vengono forniti completi di cassaforma

The holder is enclosed with the luminaire



Incasso a parete
Recessed wall version



cod. CS 4010
Cassaforma in tecnopolimero per vano ad incasso Ø 110 mm - h 100 mm
Technopolymer holder to be recessed into the wall Ø 110 mm - h 100 mm



La cassaforma deve essere installata a filo muro
Holder must be recessed flush with the wall surface

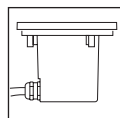

Entrata singola cavi di alimentazione con pressacavi M16 (Ø 5÷10 mm). Usare cavi flessibili. (Cavi rigidi possono compromettere la tenuta stagna IP67).
Single power supply entry cable with M16 cable glands. Use flexible cables (rigid cables may compromise IP67 rating)

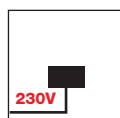

LED
Led a tensione di rete 220/240V 50/60Hz. Connessione diretta alla rete di alimentazione senza necessità di alimentatore.
LED's direct operation at 220/240V 50/60Hz. No power supply is required.

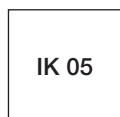

4011 - 4014



4012 - 6012 - 6014



4011

4011.66X	LED	4W	510 lm	4000 K
4011.67X	LED	4W	500 lm	3000 K

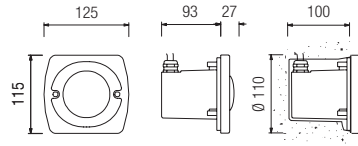

4012

4012.66X	LED	4W	510 lm	4000 K
4012.67X	LED	4W	500 lm	3000 K

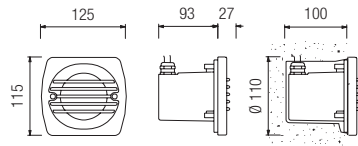

4014

4014.66X	LED	4W	510 lm	4000 K
4014.67X	LED	4W	500 lm	3000 K

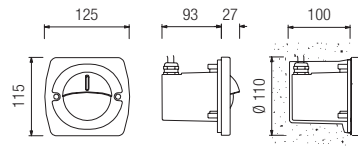

6012 INOX

6012.660	LED	4W	510 lm	4000 K
6012.670	LED	4W	500 lm	3000 K

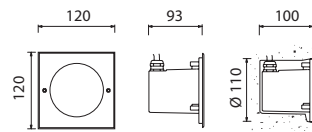

6014 INOX

6014.660	LED	4W	510 lm	4000 K
6014.670	LED	4W	500 lm	3000 K

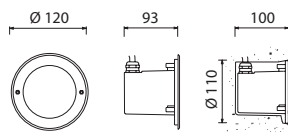

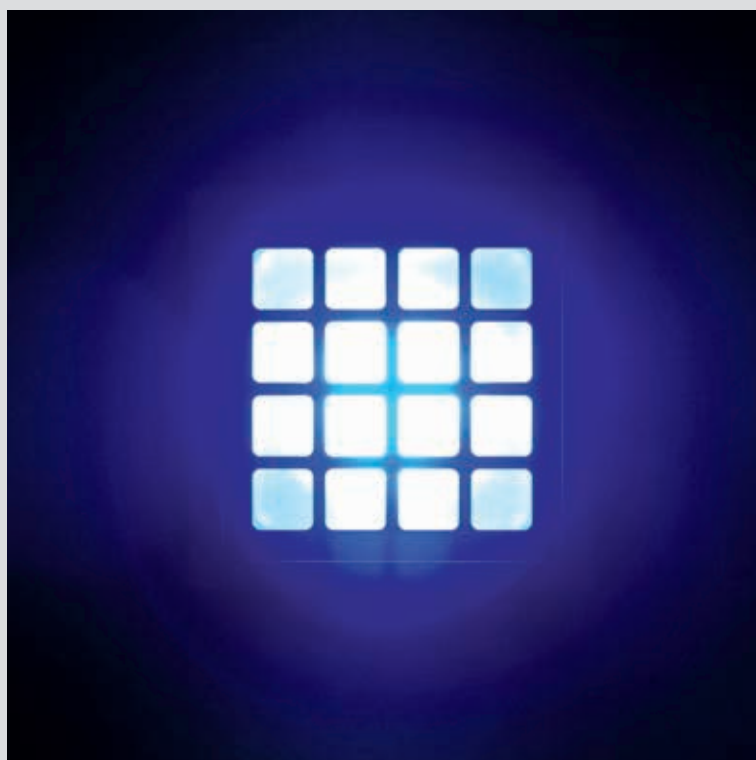



DIANA



IPSE



RITZ



FLASH



STYLE



GAMMA

DIANA

Apparecchio da incasso a parete costituito da:

- Struttura in alluminio pressofuso
- Diffusore in vetro temperato satinato
- Parabola riflettente in alluminio
- Guarnizioni in silicone
- Viti di chiusura in acciaio inox
- Cassaforma in tecnopolimero
- Verniciatura in polveri poliestere ad elevata resistenza ai raggi ultravioletti e alla corrosione

Recessed wall luminaire constructed of:

- Die-cast aluminium structure
- Tempered satin glass diffuser
- Aluminium reflector
- Silicon gaskets
- Stainless steel screws
- Technopolymer holder
- Painting using high resistance to UV and corrosion polyester powders



Colori - Colours

X=9  Antracite
Anthracite

X=4  Silver

Diffusore - Diffuser
Codice-Code 00 4090

Gli apparecchi vengono forniti completi di cassaforma
The holder is enclosed with the luminaires

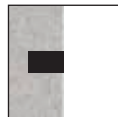

Incasso a parete
Recessed wall version



La cassaforma deve essere installata a filo muro
Holder must be recessed flush with the wall surface

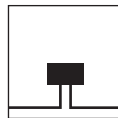

Doppia entrata cavi di alimentazione
Double power supply cables input

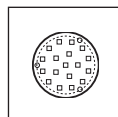

LED GX53
Non necessita di alcun alimentatore.
It does not need the power supply.



IK 05



cod. CS 49
Cassaforma in tecnopolimero da incassare nel muro prima dell'installazione della lampada
☑ 145x145 mm - h 94 mm
Technopolymer holder to be recessed into the wall before the installation of the luminaire
☑ 145x145 mm - h 94 mm

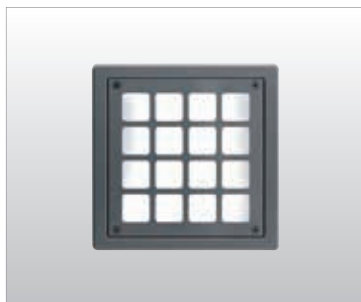

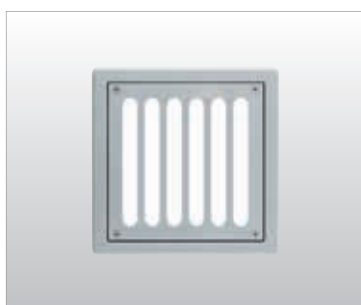
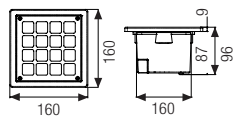

4090

- **4090.68X**  LED 6,5W GX53 650 lm 4000 K
- **4090.69X**  LED 6,5W GX53 650 lm 3000 K



4091

- **4091.68X**  LED 6,5W GX53 650 lm 4000 K
- **4091.69X**  LED 6,5W GX53 650 lm 3000 K

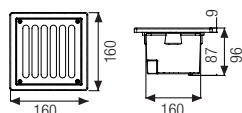

4092

- **4092.68X**  LED 6,5W GX53 650 lm 4000 K
- **4092.69X**  LED 6,5W GX53 650 lm 3000 K

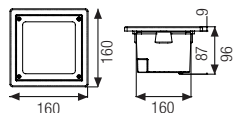

4094

- **4094.68X**  LED 6,5W GX53 650 lm 4000 K
- **4094.69X**  LED 6,5W GX53 650 lm 3000 K

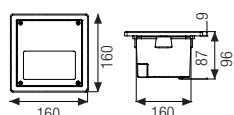

- **L'apparecchio viene fornito completo di lampadina**
Bulb enclosed with the luminaire

RITZ

Apparecchio da incasso a pavimento o a parete costituito da:

- Corpo in alluminio pressofuso verniciato
- Anello in alluminio pressofuso verniciato o in acciaio inox AISI 316L
- Diffusore in vetro temperato satinato
- Parabola riflettente in acciaio inox
- Guarnizioni in silicone
- Viti di chiusura in acciaio inox
- Cassaforma a muro in tecnopolimero
- Verniciatura in polveri poliestere ad elevata resistenza ai raggi ultravioletti e alla corrosione

Cod. 1414 - 1415

Installabile anche a pavimento. Il diffusore rimane perfettamente a filo pavimento in modo da non intralciare il camminamento

Recessed floor or wall luminaire constructed of:

- Painted die-cast aluminium body
- Painted die-cast aluminium or stainless steel AISI 316L ring
- Aluminium reflector
- Satin tempered glass diffuser
- Silicon gaskets
- Stainless steel screws
- Technopolymer wall holder
- Painting using high resistance to UV and corrosion polyester powders

Cod. 1414 - 1415

The diffuser is flush with the floor perfectly as do not obstacle the walking



IP65 INCASSO A PARETE
WALL RECESSED

IP67 INCASSO A PAVIMENTO
GROUND RECESSED

Colori - Colours Cod. 1414

X=9 Anthracite

X=4 Silver

Diffusore - Diffuser

Codice-Code 00 1414

Gli apparecchi vengono forniti completi di cassaforma

The holder is enclosed with the luminaire



Incasso a parete
Recessed wall version



Cod. 1414 - 1415
Incasso a pavimento
Recessed floor luminaire

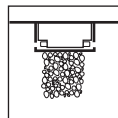

Versione terra. La cassaforma deve essere installata a filo terreno, prevedendo ghiaia di drenaggio per almeno 30 cm.
Ground luminaire. The holder must be recessed into the ground providing a drainage-gravel for at least 30 cm

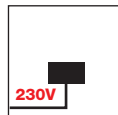

L'apparecchio è fornito completo di alimentatore elettronico 220/240V 50/60Hz posizionato all'interno dell'apparecchio.
The luminaire is supplied with a 220/240V 50/60Hz built-in power supply.

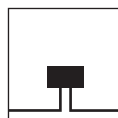

Doppia entrata cavi di alimentazione con pressacavi M16 (Ø 5÷10 mm). Usare cavi flessibili. (Cavi rigidi possono compromettere la tenuta stagna IP67).
Double power supply entry cable with M16 (Ø 5÷10 mm) cable glands. Use flexible cables (rigid cables may compromise IP67 rating)



Cod. 1414 - 1415
Apparecchio calpestabile
Walkable luminaire

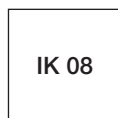

cod. CS 14
Cassaforma in tecnopolimero per vano ad incasso 88x270 mm - h 112 mm
Technopolymer holder to be recessed 88x270 mm - h mm 112



Simbolo che indica la temperatura delle superfici toccabili
Symbol indicating the temperature of the touchable surfaces

Temperatura superficie (ta 15°C)		Zona di installazione:
Surface temperature	(ta 15°C)	Intended usage:
LED	<35°C	2

NOTA: zona di installazione definita dalla norma EN 60598-2-13 Allegato A - Vedi pag. 348
Note: intended usage is defined by the standard EN 60598-2-13 Annex A - See pag. 348



1420

Copertura in acciaio inox - Installabile a parete
Stainless steel cover - Wall mounting

1420.660	LED	10W	1250 lm	4000 K
1420.670	LED	10W	1250 lm	3000 K

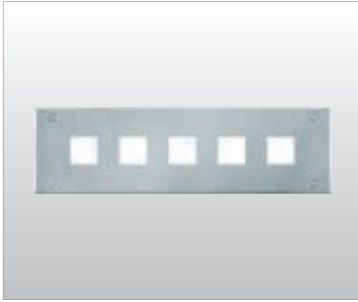
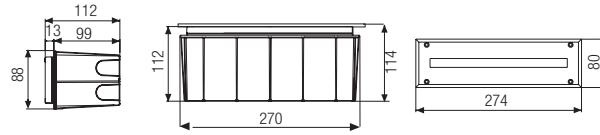

1418

Copertura in acciaio inox - Installabile a parete
Stainless steel cover - Wall mounting

1418.660	LED	10W	1250 lm	4000 K
1418.670	LED	10W	1250 lm	3000 K

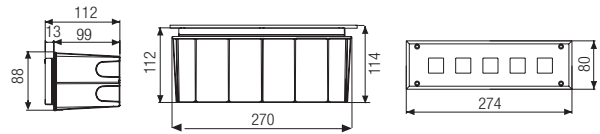

1416

Copertura in acciaio inox - Installabile a parete
Stainless steel cover - Wall mounting

1416.660	LED	10W	1250 lm	4000 K
1416.670	LED	10W	1250 lm	3000 K

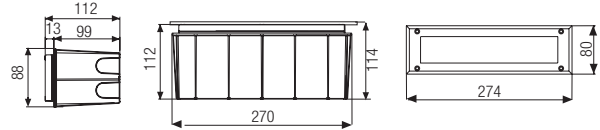

1415

Copertura in acciaio inox - Installabile a pavimento su base solida o a parete
Stainless steel cover - Solid surface floor mounting or wall mounting

1415.660	LED	10W	1250 lm	4000 K
1415.670	LED	10W	1250 lm	3000 K

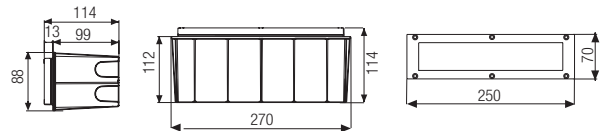

1414

Copertura in alluminio pressofuso - Installabile a pavimento su base solida o a parete
Die-cast aluminium cover - Solid surface floor mounting or wall mounting

1414.66X	LED	10W	1250 lm	4000 K
1414.67X	LED	10W	1250 lm	3000 K

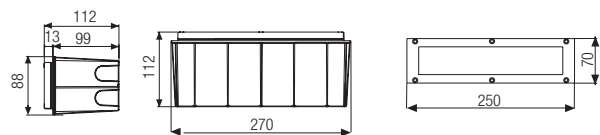

STYLE

Apparecchio da incasso a parete per illuminazione di interni ed esterni, disponibile in due dimensioni **BIG** e **MINI** costituito da:

- Corpo in alluminio pressofuso
- Copertura in acciaio inox AISI 316L
- Diffusore in vetro opale temperato
- Guarnizioni in silicone
- Cassaforma a muro in tecnopolimero
- Viti di chiusura in acciaio inox
- Verniciatura in polveri poliestere ad elevata resistenza ai raggi ultravioletti e alla corrosione

Indoor and outdoor recessed wall luminaire, available in two sizes **BIG** and **MINI** constructed of:

- Die-cast aluminium structure
- Stainless steel cover AISI 316L
- Tempered opal glass diffuser
- Silicon gaskets
- Technopolymer wall holder
- Stainless steel screws
- Painting using high resistance to UV and corrosion polyester powders



Diffusore - Diffuser
Codice-Code 00 1015 per-for MINI
Codice-Code 00 8051 per-for BIG

Gli apparecchi vengono forniti completi di cassaforma

The holder is enclosed with the luminaire

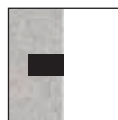

Incasso a parete
 Recessed wall version



La cassaforma deve essere installata a filo muro
 Holder must be recessed flush with the wall surface

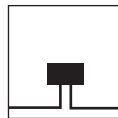

Doppia entrata cavi di alimentazione
 Double power supply cables input

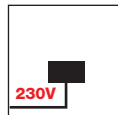

LED
 Led a tensione di rete 220/240V 50/60Hz.
 Connessione diretta alla rete di alimentazione senza necessità di alimentatore.
 LED's direct operation at 220/240V 50/60Hz.
 No power supply is required.



IK 06



cod. CS 99 per-for **STYLE MINI**
Cassaforma in tecnopolimero per vano ad incasso - 240x100x84 mm
 Technopolymer holder to be recessed into the wall - 240x100x84 mm



cod. CS 54 per-for **STYLE BIG**
Cassaforma in tecnopolimero da incassare nel muro - 313x125x100 mm
 Technopolymer holder to be recessed into the wall - 313x125x100 mm





1015 MINI
2015 BIG

STYLE MINI

1015.000	LED	4,5W	E14		
1015.550	LED	9W		1240 lm	4000 K
1015.560	LED	9W		1160 lm	3000 K

STYLE BIG

2015.000	LED	8W	E27		
2015.950	TC-D	26W	G24 d-3		
2015.550	LED	13W		1790 lm	4000 K
2015.560	LED	13W		1790 lm	3000 K

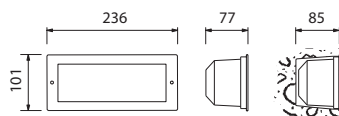

STYLE MINI

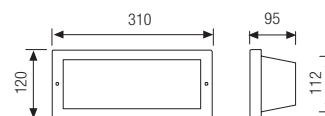

STYLE BIG

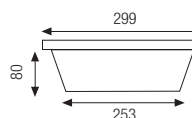

1016 MINI
2016 BIG

STYLE MINI

1016.000	LED	4,5W	E14		
1016.550	LED	9W		1240 lm	4000 K
1016.560	LED	9W		1160 lm	3000 K

STYLE BIG

2016.000	LED	8W	E27		
2016.950	TC-D	26W	G24 d-3		
2016.550	LED	13W		1790 lm	4000 K
2016.560	LED	13W		1790 lm	3000 K

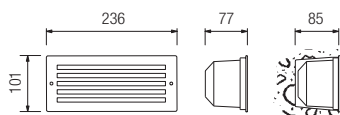

STYLE MINI

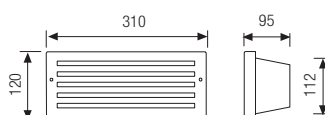

STYLE BIG

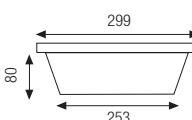

IPSE

Apparecchio da incasso a parete costituito da:

- Corpo in alluminio pressofuso verniciato
- Diffusore in vetro temperato
- Parabola riflettente in alluminio
- Guarnizioni in EPDM
- Cassaforma a muro in tecnopolimero
- Viti di chiusura in acciaio Inox
- Verniciatura in polveri poliesteri ad elevata resistenza ai raggi ultravioletti e alla corrosione

Recessed wall luminaire constructed of:

- Die-cast painted aluminium body
- Satin tempered glass diffuser
- Aluminium reflector
- EPDM gaskets
- Technopolymer wall holder
- Stainless steel screws
- Painting using high resistance to UV and corrosion polyester powders



Colori - Colours

X=9  Antracite

X=4  Silver

Diffusore - Diffuser

Codice-Code 00 8051

per/for Cod. 8051 - 8053 - 8055

Codice-Code 00 1034

per/for Cod. 8050 - 8052 - 8054

Le lampadine vengono fornite solo su richiesta

Bulbs supplied only on request

Gli apparecchi vengono forniti completi di cassaforma

The holder is enclosed with the luminaire

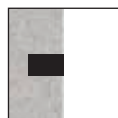

Incasso a parete
Recessed wall version



La cassaforma deve essere installata a filo muro
Holder must be recessed flush with the wall surface

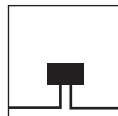

Doppia entrata cavi di alimentazione
Double power supply cables input

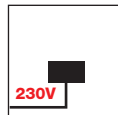

LED
Led a tensione di rete 220/240V 50/60Hz.
Connessione diretta alla rete di alimentazione senza necessità di alimentatore.
LED's direct operation at 220/240V 50/60Hz.
No power supply is required.

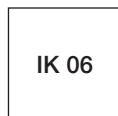

IK 06



cod. CS 19 (per/for Cod. 8050 - 8052 - 8054)
Cassaforma in tecnopolimero da incassare nel muro 275x144x80 mm
Technopolymer holder to be recessed into the wall 275x144x80 mm



cod. CS 53 (per/for Cod. 8051 - 8053 - 8055)
Cassaforma in tecnopolimero da incassare nel muro - 290x107x87 mm
Technopolymer holder to be recessed into the wall - 290x107x87 mm



8053
8052

8053.00X	LED	8W	E27	
8053.95X	TC-D	26W	G24 d-3	
8053.55X	LED	13W	1790 lm	4000 K
8053.56X	LED	13W	1790 lm	3000 K

8052.00X	LED	8W	E27	
8052.95X	TC-D	26W	G24 d-3	
8052.55X	LED	13W	1790 lm	4000 K
8052.56X	LED	13W	1790 lm	3000 K

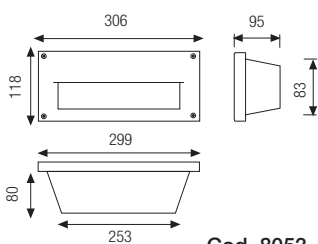

Cod. 8053

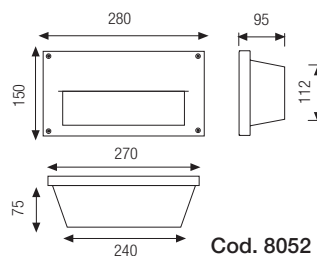

Cod. 8052



8051
8050

8051.00X	LED	8W	E27	
8051.95X	TC-D	26W	G24 d-3	
8051.55X	LED	13W	1790 lm	4000 K
8051.56X	LED	13W	1790 lm	3000 K

8050.00X	LED	8W	E27	
8050.95X	TC-D	26W	G24 d-3	
8050.55X	LED	13W	1790 lm	4000 K
8050.56X	LED	13W	1790 lm	3000 K

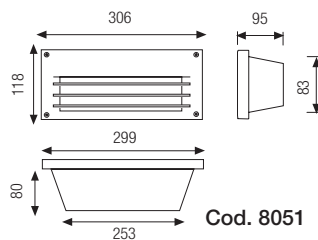

Cod. 8051

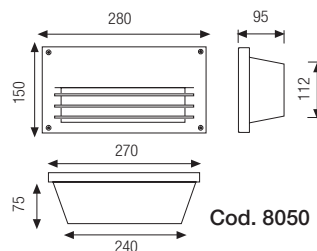

Cod. 8050



8055
8054

8055.00X	LED	8W	E27	
8055.95X	TC-D	26W	G24 d-3	
8055.55X	LED	13W	1790 lm	4000 K
8055.56X	LED	13W	1790 lm	3000 K

8054.00X	LED	8W	E27	
8054.95X	TC-D	26W	G24 d-3	
8054.55X	LED	13W	1790 lm	4000 K
8054.56X	LED	13W	1790 lm	3000 K

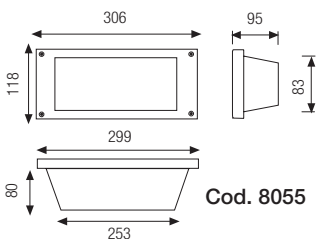

Cod. 8055

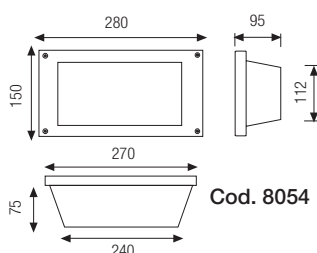

Cod. 8054

FLASH

Apparecchio da incasso a parete disponibile in due dimensioni BIG e MINI costituito da:

- Corpo in alluminio pressofuso
- Diffusore in vetro temperato satinato
- Guarnizione in silicone per Flash Mini e in EPDM per Flash Big
- Cassaforma a muro in tecnopolimero
- Viti di chiusura in acciaio inox
- Verniciatura in polveri poliestere ad elevata resistenza ai raggi ultravioletti e alla corrosione

Recessed wall luminaire, available in two sizes BIG and MINI constructed of:

- Die-cast aluminium structure
- Satin tempered glass diffuser
- Silicon gasket for Flash Mini and EPDM gasket for Flash Big
- Technopolymer wall holder
- Stainless steel screws
- Painting using high resistance to UV and corrosion polyester powders



Colori - Colours

X=9  Anthracite
Anthracite

X=4  Silver

Diffusore - Diffuser

Codice-Code 00 1034
per/for BIG

Codice-Code 00 1037
per/for MINI

Le lampadine vengono fornite solo su richiesta

Bulbs supplied only on request

Gli apparecchi vengono forniti completi di cassaforma

The holder is enclosed with the luminaire

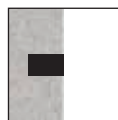

Incasso a parete
Recessed wall version



La cassaforma deve essere installata a filo muro
Holder must be recessed flush with the wall surface

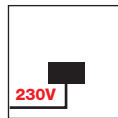

LED FLASH MINI
Led a tensione di rete 220/240V 50/60Hz.
Connessione diretta alla rete di alimentazione senza necessità di alimentatore.
LED's direct operation at 220/240V 50/60Hz.
No power supply is required.

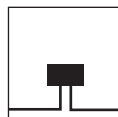

Doppia entrata cavi di alimentazione
Power supply cables input



IK 06



cod. CS 99 per/for MINI
Cassaforma in tecnopolimero per vano ad incasso - 240x100x84 mm
Technopolymer holder to be recessed into the wall - 240x100x84 mm



cod. CS 19 per/for BIG
Cassaforma in tecnopolimero da incassare nel muro 275x144x80 mm
Technopolymer holder to be recessed into the wall 275x144x80 mm



1037 MINI
1034 BIG

FLASH MINI

1037.00X	LED	4,5W	E14
1037.55X	LED	9W	1240 lm 4000 K
1037.56X	LED	9W	1160 lm 3000 K

FLASH BIG

1034.00X	LED	8W	E27
1034.95X	TC-D	26W	G24 d-3
1034.55X	LED	13W	1790 lm 4000 K
1034.56X	LED	13W	1790 lm 3000 K

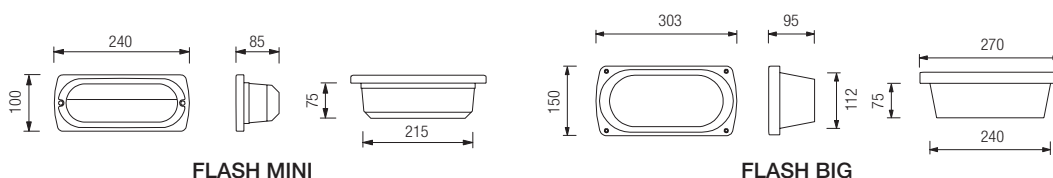

1039 MINI
1036 BIG

FLASH MINI

1039.00X	LED	4,5W	E14
1039.55X	LED	9W	1240 lm 4000 K
1039.56X	LED	9W	1160 lm 3000 K

FLASH BIG

1036.00X	LED	8W	E27
1036.95X	TC-D	26W	G24 d-3
1036.55X	LED	13W	1790 lm 4000 K
1036.56X	LED	13W	1790 lm 3000 K

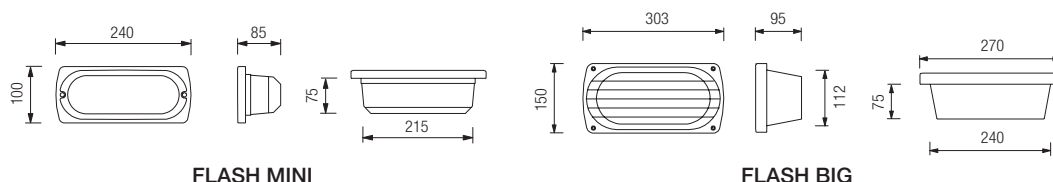

1035 MINI
1038 BIG

FLASH MINI

1035.00X	LED	4,5W	E14
1035.55X	LED	9W	1240 lm 4000 K
1035.56X	LED	9W	1160 lm 3000 K

FLASH BIG

1038.00X	LED	8W	E27
1038.95X	TC-D	26W	G24 d-3
1038.55X	LED	13W	1790 lm 4000 K
1038.56X	LED	13W	1790 lm 3000 K

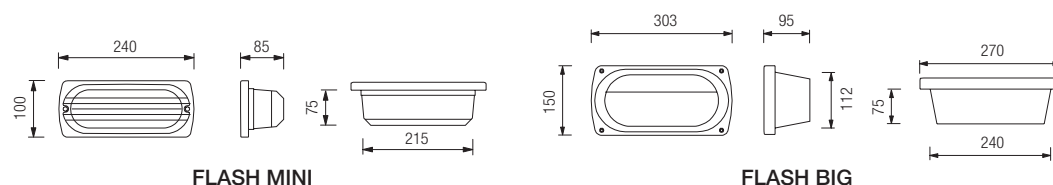

GAMMA

Apparecchio da incasso a parete costituito da:

- Corpo e anello in alluminio pressofuso
- Diffusore in vetro temperato satinato
- Guarnizione in EPDM per Gamma Big e in silicone per Gamma Mini
- Cassaforma a muro in tecnopolimero
- Viti di chiusura in acciaio inox
- Verniciatura in polveri poliestere ad elevata resistenza ai raggi ultravioletti e alla corrosione

Recessed wall luminaire constructed of:

- Die-cast aluminium body and ring
- Satin tempered glass diffuser
- EPDM gasket for Gamma Big and silicon gasket for Gamma Mini
- Technopolymer wall holder
- Stainless steel screws
- Painting using high resistance to UV and corrosion polyester powders



Colori - Colours

- X=2 Bianco
White
- X=3 Nero
Black
- X=9 Antracite
Anthracite
- X=4 Silver

Colori - Colours GAMMA OVAL

- X=2 Bianco
White
- X=3 Nero
Black

Diffusore - Diffuser

Codice-Code 00 1090
per/for **BIG**

Codice-Code 00 1093
per/for **MINI**

Codice-Code 00 1095
per/for **OVAL**

Le lampadine vengono fornite solo su richiesta

Bulbs supplied only on request

Gli apparecchi vengono forniti completi di cassaforma

The holder is enclosed with the luminaire

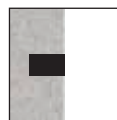

Incasso a parete
Recessed wall version



La cassaforma deve essere installata a filo muro
holder must be recessed flush with the wall surface

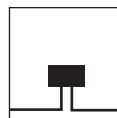

Doppia entrata cavi di alimentazione
Power supply cables input

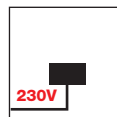

LED GAMMA MINI
Led a tensione di rete 220/240V 50/60Hz.
Connessione diretta alla rete di alimentazione senza necessità di alimentatore.
LED's direct operation at 220/240V 50/60Hz.
No power supply is required.



IK 06

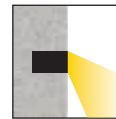

Per/for Cod. 1094
L'emissione di luce verso il basso è nel pieno rispetto delle leggi contro l'inquinamento luminoso.

The direct light emission is in full compliance with standard light pollution directives



cod. CS 99 per/for MINI
Cassaforma in tecnopolimero per vano ad incasso - 240x100x84 mm
Technopolymer holder to be recessed into the wall - 240x100x84 mm



cod. CS 19 per/for BIG
Cassaforma in tecnopolimero da incassare nel muro 275x144x80 mm
Technopolymer holder to be recessed into the wall 275x144x80 mm



1010

1010.00X	LED	8W	E27		
1010.95X	 TC-D	26W	G24 d-3		
1010.55X	LED	13W		1790 lm	4000 K
1010.56X	LED	13W		1790 lm	3000 K

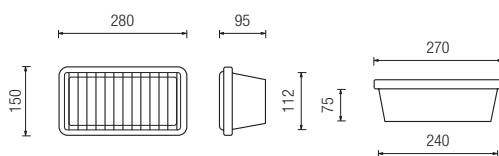

1090

1090.00X	LED	8W	E27		
1090.95X	 TC-D	26W	G24 d-3		
1090.55X	LED	13W		1790 lm	4000 K
1090.56X	LED	13W		1790 lm	3000 K

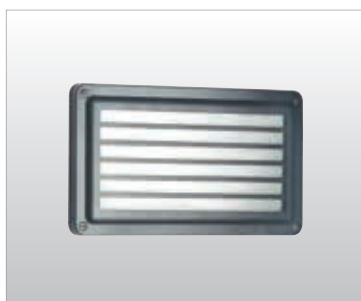
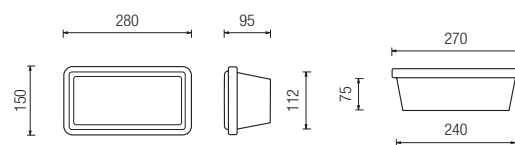

1091

1091.00X	LED	8W	E27		
1091.95X	 TC-D	26W	G24 d-3		
1091.55X	LED	13W		1790 lm	4000 K
1091.56X	LED	13W		1790 lm	3000 K

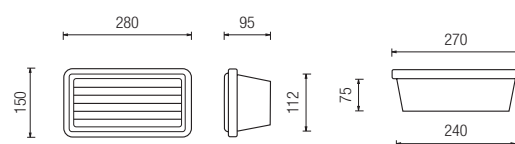

GAMMA MINI

GAMMA MINI



1011

1011.00X	LED	4,5W	E14	
1011.55X	LED	9W	1240 lm	4000 K
1011.56X	LED	9W	1160 lm	3000 K

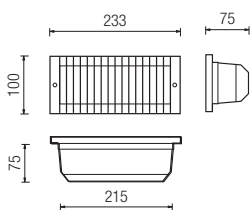

1099

1099.00X	LED	4,5W	E14	
1099.55X	LED	9W	1240 lm	4000 K
1099.56X	LED	9W	1160 lm	3000 K

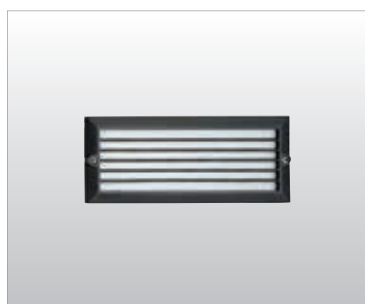
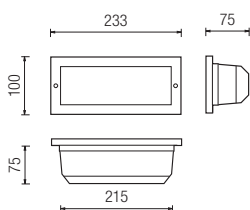

1093

1093.00X	LED	4,5W	E14	
1093.55X	LED	9W	1240 lm	4000 K
1093.56X	LED	9W	1160 lm	3000 K

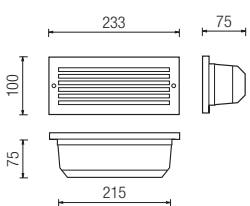

1094

1094.00X	LED	4,5W	E14	
1094.55X	LED	9W	1240 lm	4000 K
1094.56X	LED	9W	1160 lm	3000 K

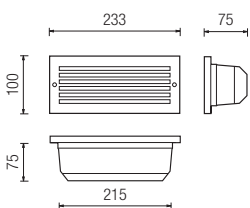



1095

1095.00X LED 8W E27

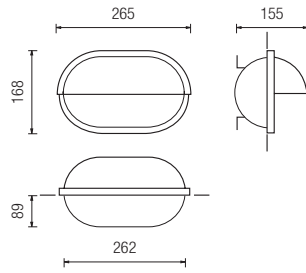

1096

1096.00X LED 8W E27

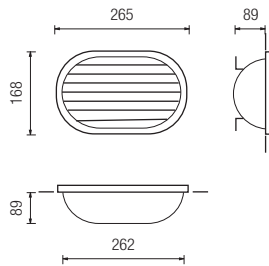

1097

1097.00X LED 8W E27

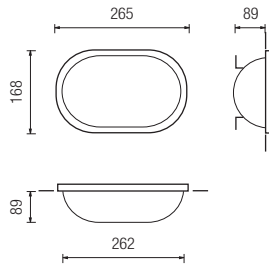



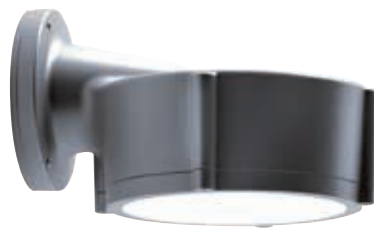

DIG



MIA

DIG

Apparecchio da esterni per installazione a parete costituito da:

- Corpo in alluminio pressofuso verniciato
- Diffusore in vetro temperato satinato
- Parabola riflettente in alluminio
- Guarnizioni in silicone
- Viti di chiusura in acciaio inox
- Verniciatura in polveri poliesteri ad elevata resistenza ai raggi ultravioletti e alla corrosione

Wall outdoor luminaire constructed of:

- Painted die-cast aluminium body
- Satin tempered glass diffuser
- Aluminium reflector
- Silicon gaskets
- Stainless steel screws
- Painting using high resistance to UV and corrosion polyester powders



Colori - Colours

X=9  Antracite
Anthracite

X=4  Silver

Diffusore - Diffuser

Codice-Code 00 5050

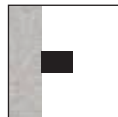

Installazione a parete
Wall mounting

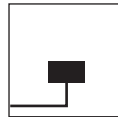

Entrata singola cavi di alimentazione
Single power supply cables input

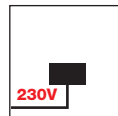

LED
L'apparecchio è fornito completo di alimentatore elettronico 220/240V 50/60Hz posizionato all'interno dell'apparecchio.
The luminaire is supplied with a 220/240V 50/60Hz built-in power supply

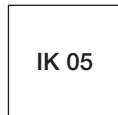

IK 05

**5050**

5050.66X	LED	10W	1250 lm	4000 K
5050.67X	LED	10W	1250 lm	3000 K

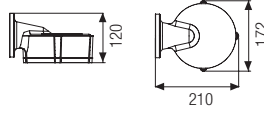

MIA

Proiettore per interni ed esterni disponibile in due dimensioni BIG e MINI costituito da:

- Corpo in alluminio pressofuso ed estruso verniciato
- Diffusore in vetro trasparente temperato
- Parabola riflettente in alluminio
- Guarnizioni in silicone
- Viti di chiusura in acciaio inox
- Picchetto in plastica
- Verniciatura in polveri poliestere ad elevata resistenza ai raggi ultravioletti e alla corrosione

Indoor and outdoor spotlight available in two sizes BIG and MINI constructed of:

- Painted extruded and die-casted aluminium body
- Transparent tempered glass diffuser
- Aluminium reflector
- Silicon gaskets
- Stainless steel screws
- Plastic spike
- Painting using high resistance to UV and corrosion polyester powders

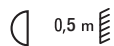

Colori - Colours

X=9  Antracite
Anthracite

X=4  Silver

Diffusore - Diffuser

Codice-Code 00 4054
per/for MIA MINI

Codice-Code 00 4058
per/for MIA BIG

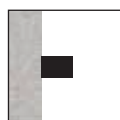

Cod. 4054 - 4058
Installazione a parete
Wall mounting

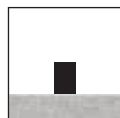

Cod. 4052
Installazione a terra
Floor mounting

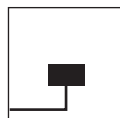

Entrata singola cavi di alimentazione
Single power supply cables input

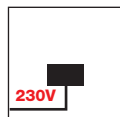

LED
Led a tensione di rete 220/240V 50/60Hz.
Connessione diretta alla rete di alimentazione
senza necessità di alimentatore.
LED's direct operation at 220/240V 50/60Hz.
No power supply is required.



Lampadina LED GU10 IP20 dimmerabile
LED GU10 IP20 dimmable bulb



IK 09

MIA CON PICCHETTO A TERRA
Apparecchio provvisto di cavo H05RN-F
con spina 2P+T IP44

MIA WITH GROUND SPIKE
Luminaire provided with flexible cable H05RN-F
and plug 2P+T IP44





4054 MINI

- **4054.05X**  LED GU10 4,9W 560 lm 4000 K
- **4054.06X**  LED GU10 4,9W 560 lm 3000 K

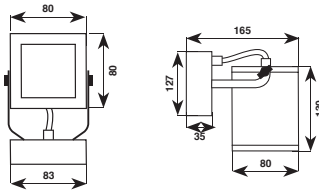

4058 BIG

- 4058.20X** LED COB 15W 1740 lm 4000 K
- 4058.21X** LED COB 15W 1670 lm 3000 K

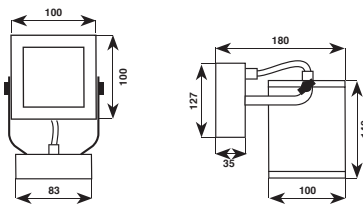

4052 BIG

Installazione a terra con picchetto - Ground fixing with spike

- 4052.20X** LED COB 15W 1740 lm 4000 K
- 4052.21X** LED COB 15W 1670 lm 3000 K

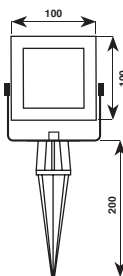

- **L'apparecchio viene fornito completo di lampadina**
Bulb enclosed with the luminaire





SPRINT



SPARK

SPARK STELO



SPRINT

Proiettore per interni ed esterni costituito da:

- Struttura in alluminio pressofuso verniciato
- Diffusore in vetro temperato
- Parabola riflettente in alluminio
- Guarnizioni in silicone
- Viti di chiusura in acciaio inox
- Picchetto in plastica
- Verniciatura in polveri poliesteri ad elevata resistenza ai raggi ultravioletti e alla corrosione

Indoor and outdoor spotlight constructed of:

- Painted die-cast aluminium structure
- Tempered glass diffuser
- Aluminium reflector
- Silicon gaskets
- Stainless steel screws
- Plastic Spike
- Painting using high resistance to UV and corrosion polyester powders



Colori - Colours

X=9  Antracite

X=4  Silver

Diffusore - Diffuser

Codice-Code 00 4010

Vetro piano/Flat glass

Codice-Code 00 4011

Vetro cupolino/Domed glass

Le lampadine vengono fornite solo su richiesta ad eccezione della versione GU10 LED

Bulbs supplied only on request except for GU10 LED version



Installazione a soffitto
Ceiling mounting

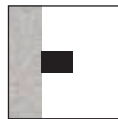

Installazione a parete
Wall mounting

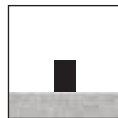

Installazione a terra con picchetto
Ground fixing with spike



Lampadina LED GU10 IP20 dimmerabile
LED GU10 IP20 dimmable bulb



ACCESSORIO

art. PQ 40

Picchetto a terra in plastica
provvisto di cavo H05RN-F
con spina 2P+T IP44.

Plastic ground spike
provided with flexible cable H05RN-F
and plug 2P+T IP44.

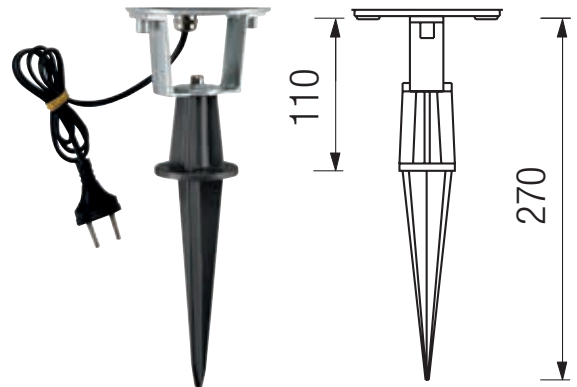

Installazione a terra con picchetto

Ground fixing with spike

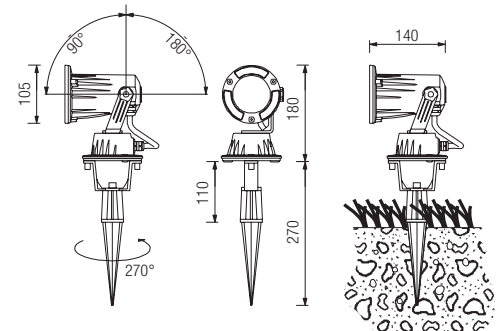

Vetro piano / Flat glass



2010 ○ anello / ring

2010.12X		QT12	35W	GY 6.35	12V
-----------------	--	------	-----	---------	-----

Con trasformatore elettronico incorporato / Built-in electronic transformer

● 2010.05X		LED	GU10	4,9W	560 lm	4000 K
● 2010.06X		LED	GU10	4,9W	560 lm	3000 K

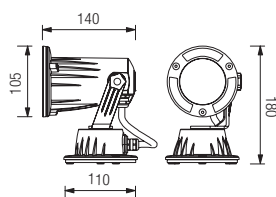

2011 ● griglia / grid

2011.12X		QT12	35W	GY 6.35	12V
-----------------	--	------	-----	---------	-----

Con trasformatore elettronico incorporato / Built-in electronic transformer

● 2011.05X		LED	GU10	4,9W	560 lm	4000 K
● 2011.06X		LED	GU10	4,9W	560 lm	3000 K

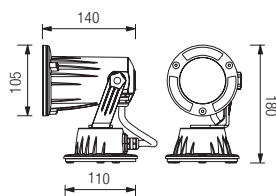

Vetro cupolino / Doned glass



2020 ○ anello / ring

2020.12X		QT12	35W	GY 6.35	12V
-----------------	--	------	-----	---------	-----

Con trasformatore elettronico incorporato / Built-in electronic transformer

● 2020.05X		LED	GU10	4,9W	560 lm	4000 K
● 2020.06X		LED	GU10	4,9W	560 lm	3000 K

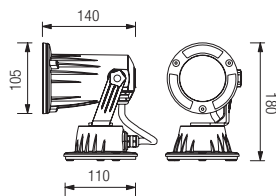

2024

2024.12X		QT12	35W	GY 6.35	12V
-----------------	--	------	-----	---------	-----

Con trasformatore elettronico incorporato / Built-in electronic transformer

● 2024.05X		LED	GU10	4,9W	560 lm	4000 K
● 2024.06X		LED	GU10	4,9W	560 lm	3000 K

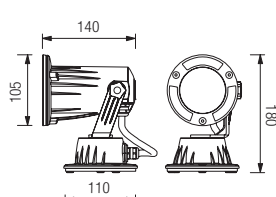

- L'apparecchio viene fornito completo di lampadina
Bulb enclosed with the luminaire

SPARK

Proiettore per interni ed esterni costituito da:

- Corpo in alluminio pressofuso verniciato
- Diffusore in vetro trasparente temperato
- Parabola riflettente in alluminio
- Guarnizioni in silicone
- Viti di chiusura in acciaio inox
- Picchetto in plastica
- Verniciatura in polveri poliestere ad elevata resistenza ai raggi ultravioletti e alla corrosione

Indoor and outdoor spotlight constructed of:

- Painted die-cast aluminium body
- Transparent tempered glass diffuser
- Aluminium reflector
- Silicon gaskets
- Stainless steel screws
- Plastic spike
- Painting using high resistance to UV and corrosion polyester powders



SPARK STELO

Apparecchio per esterni costituito da:

- Corpo in alluminio pressofuso verniciato
- Palo in alluminio estruso verniciato
- Diffusore in vetro

Outdoor post luminaire constructed of:

- Painted die-cast aluminium body
- Painted extruded aluminium post
- Glass diffuser



Colori - Colours

X=9  Antracite
Anthracite

X=4  Silver

Diffusore - Diffuser

Codice-Code 00 1080



Cod. 1080 - 1081
Installazione a soffitto
Ceiling mounting

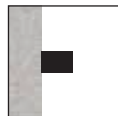

Cod. 1080 - 1081
Installazione a parete
Wall mounting

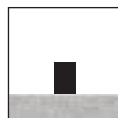

Cod. 1082 - 1083 - 1086 - 1088
Installazione a terra
Floor mounting

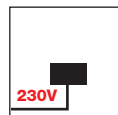

LED
Led a tensione di rete 220/240V 50/60Hz.
Connessione diretta alla rete di alimentazione
senza necessità di alimentatore.
LED's direct operation at 220/240V 50/60Hz.
No power supply is required.



Lampadina LED PAR30 IP65 dimmerabile
LED PAR30 IP65 dimmable bulb



IK 07

SPARK CON PICCHETTO A TERRA
Apparecchio provvisto di cavo H05RN-F
con spina 2P+T IP44

SPARK WITH GROUND SPIKE
Luminaire provided with flexible cable H05RN-F
and plug 2P+T IP44





1080 ○ anello / ring
1081 ● griglia / grid

Installazione a parete

Wall mounting

- **1080.05X** LED PAR30 9,5W E27 800 lm 4000 K 40°
 - **1080.06X** LED PAR30 9,5W E27 800 lm 3000 K 40°
 - 1080.45X** LED 17,6W 2270 lm 4000 K
 - 1080.46X** LED 17,6W 2125 lm 3000 K
-
- **1081.05X** LED PAR30 9,5W E27 800 lm 4000 K 40°
 - **1081.06X** LED PAR30 9,5W E27 800 lm 3000 K 40°
 - 1081.45X** LED 17,6W 2270 lm 4000 K
 - 1081.46X** LED 17,6W 2125 lm 3000 K

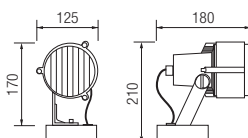

1082 ○ anello / ring
1083 ● griglia / grid

Installazione a terra con picchetto

Ground fixing with spike

- **1082.05X** LED PAR30 9,5W E27 800 lm 4000 K 40°
 - **1082.06X** LED PAR30 9,5W E27 800 lm 3000 K 40°
 - 1082.45X** LED 17,6W 2270 lm 4000 K
 - 1082.46X** LED 17,6W 2125 lm 3000 K
-
- **1083.05X** LED PAR30 9,5W E27 800 lm 4000 K 40°
 - **1083.06X** LED PAR30 9,5W E27 800 lm 3000 K 40°
 - 1083.45X** LED 17,6W 2270 lm 4000 K
 - 1083.46X** LED 17,6W 2125 lm 3000 K

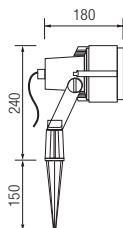

1088 H 700 ○ anello / ring
1086 H 450 ○ anello / ring

SPARK STELO

- **1088.05X** LED PAR30 9,5W E27 800 lm 4000 K 40°
 - **1088.06X** LED PAR30 9,5W E27 800 lm 3000 K 40°
 - 1088.45X** LED 17,6W 2270 lm 4000 K
 - 1088.46X** LED 17,6W 2125 lm 3000 K
-
- **1086.05X** LED PAR30 9,5W E27 800 lm 4000 K 40°
 - **1086.06X** LED PAR30 9,5W E27 800 lm 3000 K 40°
 - 1086.45X** LED 17,6W 2270 lm 4000 K
 - 1086.46X** LED 17,6W 2125 lm 3000 K

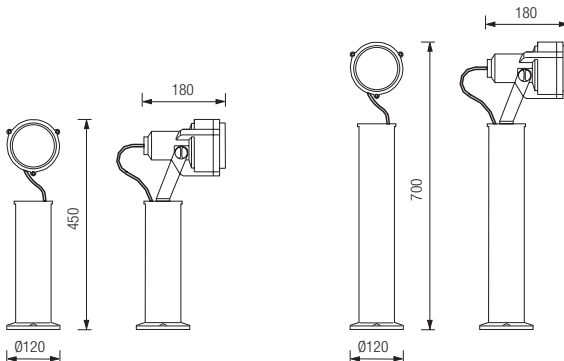

1086 H 450

1088 H 700

- L'apparecchio viene fornito completo di lampadina bulb enclosed with the luminaire

SPARK BIG

Proiettore per interni ed esterni costituito da:

- Corpo in alluminio pressofuso verniciato
- Diffusore in vetro trasparente temperato
- Parabola riflettente in alluminio
- Guarnizioni in silicone
- Viti di chiusura in acciaio inox
- Picchetto in plastica
- Verniciatura in polveri poliestere ad elevata resistenza ai raggi ultravioletti e alla corrosione

Indoor and outdoor spotlight constructed of:

- Painted die-cast aluminium body
- Transparent tempered glass diffuser
- Aluminium reflector
- Silicon gaskets
- Stainless steel screws
- Plastic spike
- Painting using high resistance to UV and corrosion polyester powders

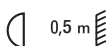

Colori - Colours

X=9  Antracite
Anthracite

X=4  Silver

Diffusore - Diffuser

Codice-Code 00 1780



Cod. 1780 - 1781
Installazione a soffitto
Ceiling mounting



Cod. 1780 - 1781
Installazione a parete
Wall mounting



Cod. 1782 - 1783
Installazione a terra
Floor mounting

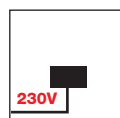

LED
Led a tensione di rete 220/240V 50/60Hz.
Connessione diretta alla rete di alimentazione
senza necessità di alimentatore.
LED's direct operation at 220/240V 50/60Hz.
No power supply is required.



Lampadina LED PAR 38 IP65 dimmerabile
LED PAR 38 IP65 dimmable bulb



IK 07

SPARK CON PICCHETTO A TERRA
Apparecchio provvisto di cavo H05RN-F
con spina 2P+T IP44

SPARK WITH GROUND SPIKE
Luminaire provided with flexible cable H05RN-F
and plug 2P+T IP44



1780 ○ anello / ring



1781 ● griglia / grid

Installazione a parete

Wall mounting

● 1780.05X	LED PAR38	16W	E27	1400 lm	4000 K	40°
● 1780.06X	LED PAR38	16W	E27	1400 lm	3000 K	40°
1780.66X	LED	17,6W		2270 lm	4000 K	
1780.67X	LED	17,6W		2125 lm	3000 K	
● 1781.05X	LED PAR38	16W	E27	1400 lm	4000 K	40°
● 1781.06X	LED PAR38	16W	E27	1400 lm	3000 K	40°
1781.66X	LED	17,6W		2270 lm	4000 K	
1781.67X	LED	17,6W		2125 lm	3000 K	

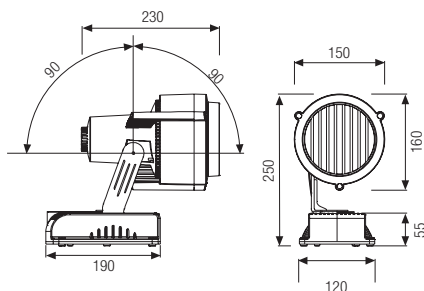

Installazione a terra con picchetto

Ground fixing with spike

● 1782.05X	LED PAR38	16W	E27	1400 lm	4000 K	40°
● 1782.06X	LED PAR38	16W	E27	1400 lm	3000 K	40°
1782.66X	LED	17,6W		2270 lm	4000 K	
1782.67X	LED	17,6W		2125 lm	3000 K	
● 1783.05X	LED PAR38	16W	E27	1400 lm	4000 K	40°
● 1783.06X	LED PAR38	16W	E27	1400 lm	3000 K	40°
1783.66X	LED	17,6W		2270 lm	4000 K	
1783.67X	LED	17,6W		2125 lm	3000 K	



1782 ○ anello / ring



1783 ● griglia / grid

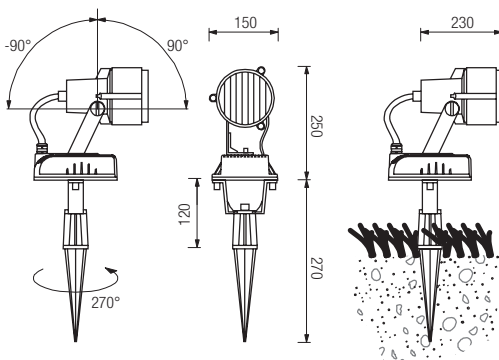

- L'apparecchio viene fornito completo di lampadina
bulb enclosed with the luminaire





MATCH

LIGHT YOUR MATCH

MATCH

Apparecchio per illuminazione di esterni costituito da:

- Palo in alluminio estruso verniciato
- Struttura superiore in alluminio pressofuso verniciato
- Diffusore in policarbonato trasparente
- Led ad alta efficienza
- Guarnizione in silicone
- Viti di chiusura in acciaio inox
- Verniciatura in polveri poliestere ad elevata resistenza ai raggi ultravioletti e alla corrosione

Outdoor luminaire constructed of:

- Painted extruded aluminium post
- Painted die-cast aluminium head
- Satin or transparent glass diffuser
- High efficiency led
- Silicon gasket
- Stainless steel screws
- Painting using high resistance to UV and corrosion polyester powders



Colori - Colours

- X=3 Nero / Black
- X=9 Antracite / Anthracite
- X=4 Silver

Diffusore - Diffuser

Codice-Code **08 4330**
policarbonato trasparente /
transparent polycarbonate

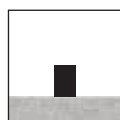

Installazione a terra
Floor mounting

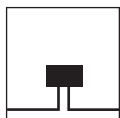

Doppia entrata cavi di alimentazione
Double power supply cables input

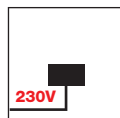

LED
L'apparecchio è fornito completo di alimentatore elettronico 220/240V 50/60Hz posizionato all'interno dell'apparecchio.
The luminaire is supplied with a 220/240V 50/60Hz built-in power supply.

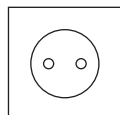

Compreso di controbases di fissaggio a terra
Root-mount ground fixing enclosed



IK 10

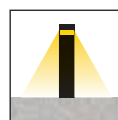

L'emissione di luce verso il basso è nel pieno rispetto delle leggi contro l'inquinamento luminoso.

The direct light emission is in full compliance with standard light pollution directives

OPTIONAL Cod. TR 43

Flangia: accessorio per palo.
Flange: accessory for post.

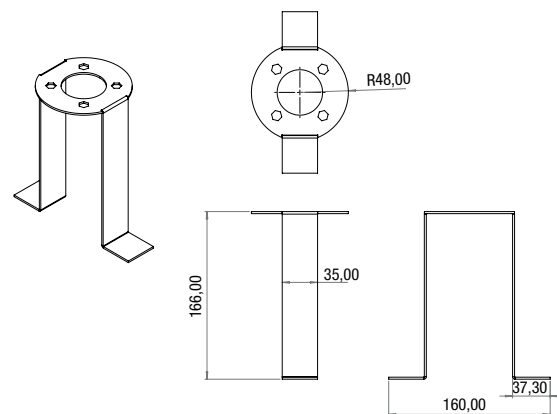



4332 H 450

4332.66X	LED	11,5W	1900 lm	4000 K
4332.67X	LED	11,5W	1900 lm	3000 K

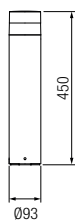

4331 H 600

4331.66X	LED	11,5W	1900 lm	4000 K
4331.67X	LED	11,5W	1900 lm	3000 K

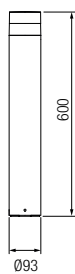

4330 H 850

4330.66X	LED	11,5W	1900 lm	4000 K
4330.67X	LED	11,5W	1900 lm	3000 K

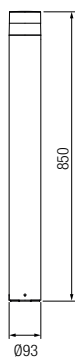

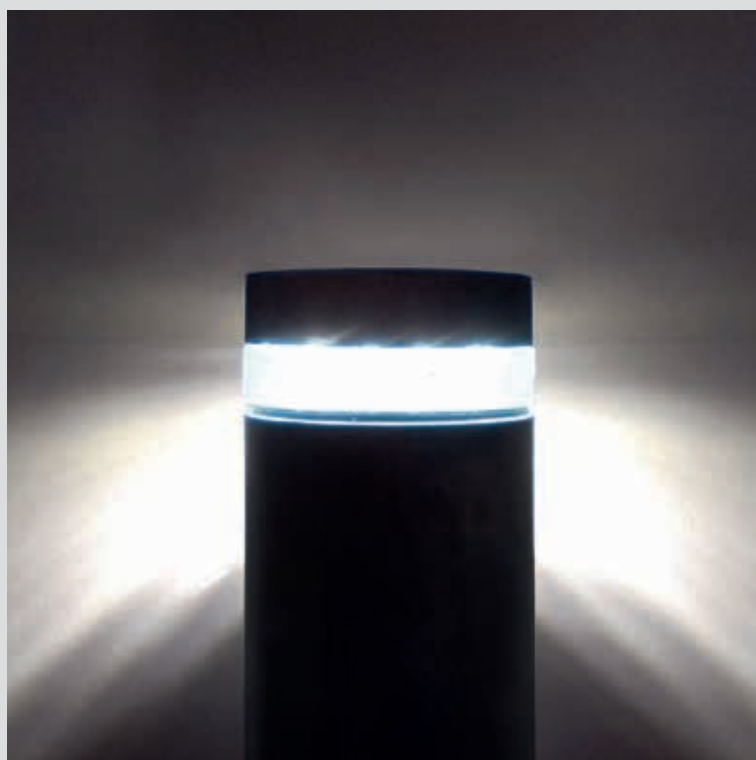



NECK

NECK

Apparecchio per illuminazione di esterni costituito da:

- Palo in alluminio estruso verniciato
- Struttura superiore in alluminio pressofuso verniciato
- Diffusore in policarbonato trasparente
- Led ad alta efficienza
- Lenti asimmetriche
- Guarnizione in silicone
- Viti di chiusura in acciaio inox
- Verniciatura in polveri poliestere ad elevata resistenza ai raggi ultravioletti e alla corrosione

Outdoor luminaire constructed of:

- Painted extruded aluminium post
- Painted die-cast aluminium head
- Satin or transparent glass diffuser
- High efficiency led
- Asymmetrical lens
- Silicon gasket
- Stainless steel screws
- Painting using high resistance to UV and corrosion polyester powders



Colori - Colours

- X=3 Nero
Black
- X=9 Antracite
Anthracite
- X=4 Silver

Diffusore - Diffuser
Codice-Code 08 8045
policarbonato trasparente/
transparent polycarbonate

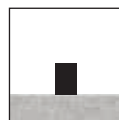

Installazione a terra
Floor mounting

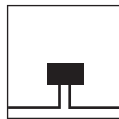

Doppia entrata cavi di alimentazione
Double power supply cables input

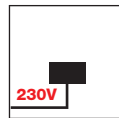

L'apparecchio è fornito completo di alimentatore elettronico 220/240V 50/60Hz posizionato all'interno dell'apparecchio.
The luminaire is supplied with a 220/240V 50/60Hz built-in power supply.

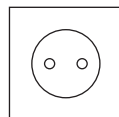

Compreso di controbase di fissaggio a terra
Root-mount ground fixing enclosed



IK 10

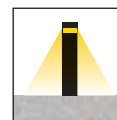

L'emissione di luce verso il basso è nel pieno rispetto delle leggi contro l'inquinamento luminoso.

The direct light emission is in full compliance with standard light pollution directives

OPTIONAL Cod. TR 8049

Flangia: accessorio per palo.
Flange: accessory for post.

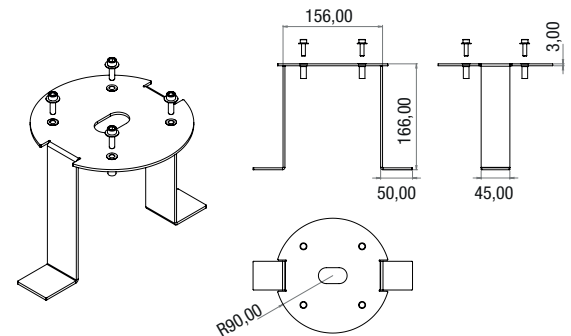



8045 H 400

8045.66X	LED	25W	3020 lm	4000 K
8045.67X	LED	25W	2880 lm	3000 K
8045.36X	LED	40W	4150 lm	4000 K
8045.37X	LED	40W	3900 lm	3000 K

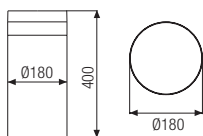

8047 H 700

8047.66X	LED	25W	3020 lm	4000 K
8047.67X	LED	25W	2880 lm	3000 K
8047.36X	LED	40W	4150 lm	4000 K
8047.37X	LED	40W	3900 lm	3000 K

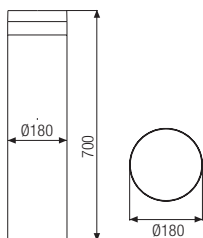

8049 H 1040

8049.66X	LED	25W	3020 lm	4000 K
8049.67X	LED	25W	2880 lm	3000 K
8049.36X	LED	40W	4150 lm	4000 K
8049.37X	LED	40W	3900 lm	3000 K

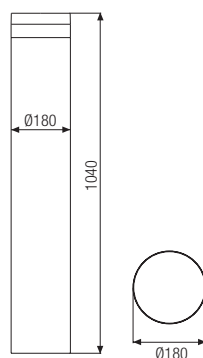





PIN

PIN

Apparecchio per illuminazione di esterni costituito da:



- Palo in alluminio estruso verniciato
- Struttura superiore in alluminio pressofuso verniciato
- Diffusore in vetro
- Guarnizione in silicone
- Viti di chiusura in acciaio inox
- Verniciatura in polveri poliestere ad elevata resistenza ai raggi ultravioletti e alla corrosione

Outdoor luminaire constructed of:

- Painted extruded aluminium post
- Painted die-cast aluminium head
- Glass diffuser
- Silicon gasket
- Stainless steel screws
- Painting using high resistance to UV and corrosion polyester powders



Colori - Colours

- X=3  Nero
Black
- X=9  Antracite
Anthracite
- X=4  Silver

Diffusore - Diffuser
Codice-Code 08 5180

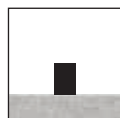

Installazione a terra
Floor mounting

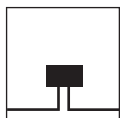

Doppia entrata cavi di alimentazione
Double power supply cables input

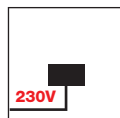

L'apparecchio è fornito completo di alimentatore elettronico 220/240V 50/60Hz posizionato all'interno dell'apparecchio.
The luminaire is supplied with a 220/240V 50/60Hz built-in power supply.



IK 07

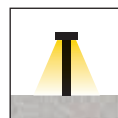

L'emissione di luce verso il basso è nel pieno rispetto delle leggi contro l'inquinamento luminoso.

The direct light emission is in full compliance with standard light pollution directives

ACCESSORIO (incluso)
ACCESSORY (included)

Cod. TR 5180

Flangia: accessorio per palo.
Flange: accessory for post.

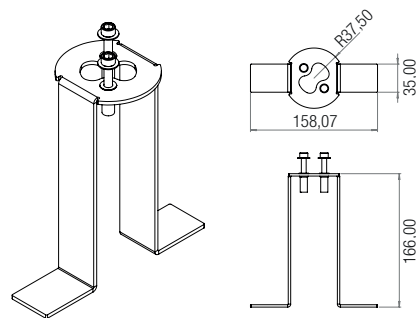

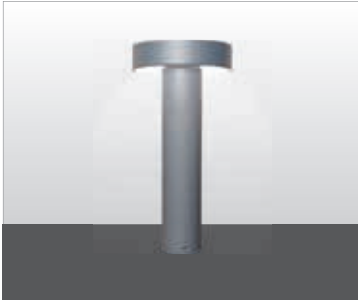

5182 H 460

5182.66X	LED	25W	3020 lm	4000 K
5182.67X	LED	25W	2880 lm	3000 K

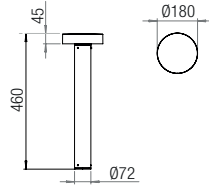

5181 H 660

5181.66X	LED	25W	3020 lm	4000 K
5181.67X	LED	25W	2880 lm	3000 K

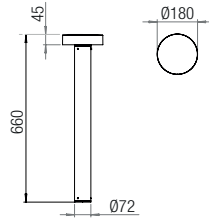

5180 H 1060

5180.66X	LED	25W	3020 lm	4000 K
5180.67X	LED	25W	2880 lm	3000 K

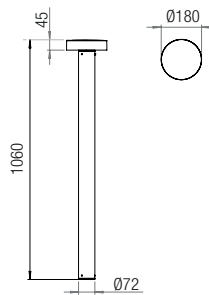





AKITA

AKITA

Apparecchio per illuminazione di esterni costituito da:

- Struttura in alluminio pressofuso verniciato
- Diffusore in vetro
- Guarnizione in silicone
- Viti di chiusura in acciaio inox
- Verniciatura in polveri poliestere ad elevata resistenza ai raggi ultravioletti e alla corrosione

Outdoor luminaire constructed of:

- Painted die-cast aluminium structure
- Glass diffuser
- Silicon gasket
- Stainless steel screws
- Painting using high resistance to UV and corrosion polyester powders



Colori - Colours

X=9  Antracite
Anthracite

X=4  Silver

Diffusore - Diffuser

Codice-Code 00 7070

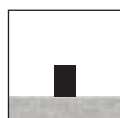

Installazione a terra
Floor mounting

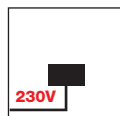

LED

L'apparecchio è fornito completo di alimentatore elettronico 220/240V 50/60Hz posizionato all'interno dell'apparecchio.

The luminaire is supplied with a 220/240V 50/60Hz built-in power supply



IK 10



L'emissione di luce verso il basso è nel pieno rispetto delle leggi contro l'inquinamento luminoso.

The direct light emission is in full compliance with standard light pollution directives



7070

7070.65X	LED	15W	2300 lm	4000 K
7070.66X	LED	15W	2300 lm	3000 K

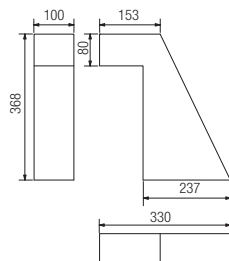





GRETA

GRETA MINI

Apparecchio per illuminazione di esterni costituito da:

- Palo in alluminio estruso verniciato
- Struttura superiore in alluminio pressofuso verniciato
- Diffusore in policarbonato
- Guarnizione in silicone
- Viti di chiusura in acciaio inox
- Verniciatura in polveri poliestere ad elevata resistenza ai raggi ultravioletti e alla corrosione

Outdoor luminaire constructed of:

- Painted extruded aluminium post
- Painted die-cast aluminium head
- Polycarbonate diffuser
- Silicon gasket
- Stainless steel screws
- Painting using high resistance to UV and corrosion polyester powders



Colori - Colours

X=9  Antracite
Anthracite

X=4  Silver

Diffusore - Diffuser

Codice-Code 08 3050

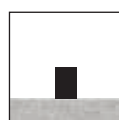

Installazione a terra
Floor mounting



Cod. 3056
Installazione a parete
Wall mounting

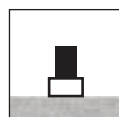

Cod. 3056
Installazione su muretto
Installation on a low fencing wall

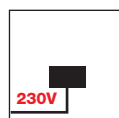

LED

L'apparecchio è fornito completo di alimentatore elettronico 220/240V 50/60Hz posizionato all'interno dell'apparecchio.

The luminaire is supplied with a 220/240V 50/60Hz built-in power supply



IK 08

OPTIONAL Cod. TR 3050

Flangia: accessorio per palo.

Flange: accessory for post.

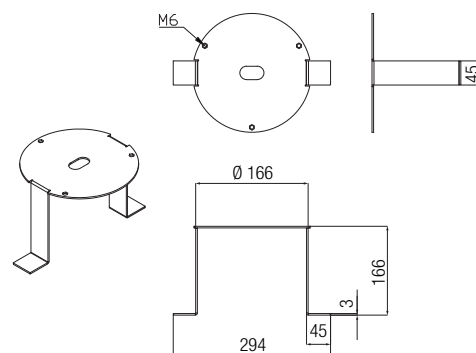

Diffusore in policarbonato
Polycarbonate diffuser

Installazione a muro o su muretto

Wall mounting or on a low fencing wall



3056 H 208

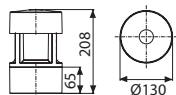

3056.00X	LED	15W	E27	
3056.66X	LED	15W	2300 lm	4000 K
3056.67X	LED	15W	2300 lm	3000 K



3052 H 360

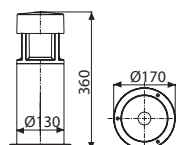

3052.00X	LED	15W	E27	
3052.66X	LED	15W	2300 lm	4000 K
3052.67X	LED	15W	2300 lm	3000 K



3051 H 650

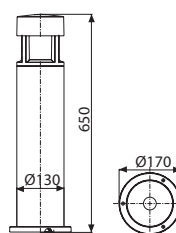

3051.00X	LED	15W	E27	
3051.66X	LED	15W	2300 lm	4000 K
3051.67X	LED	15W	2300 lm	3000 K



3050 H 1000

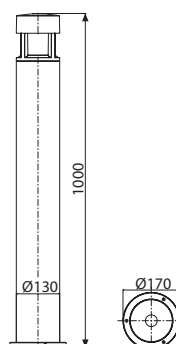

3050.00X	LED	15W	E27	
3050.66X	LED	15W	2300 lm	4000 K
3050.67X	LED	15W	2300 lm	3000 K

GRETA BIG

Apparecchio per illuminazione di esterni a luce diretta o indiretta costituito da:

- Palo in alluminio estruso verniciato
- Struttura superiore in alluminio pressofuso verniciato
- Diffusore in vetro satinato o trasparente oppure in policarbonato
- Parabola riflettente in alluminio
- Guarnizione in silicone
- Viti di chiusura in acciaio inox
- Verniciatura in polveri poliestere ad elevata resistenza ai raggi ultravioletti e alla corrosione

Outdoor luminaire constructed of:

- Painted extruded aluminium post
- Painted die-cast aluminium head
- Satin or transparent glass diffuser or polycarbonate
- Aluminium reflector
- Silicon gasket
- Stainless steel screws
- Painting using high resistance to UV and corrosion polyester powders



Colori - Colours

X=9  Antracite
Anthracite

X=4  Silver

Diffusore - Diffuser

Codice-Code 08 8040
vetro satinato/satin glass

Codice-Code 00 8140
vetro trasparente/transparent glass

Codice-Code 00 8840
vetro trasparente/transparent glass

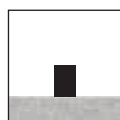

Installazione a terra
Floor mounting



Installazione a parete Cod. 8146 - 8046
Wall mounting

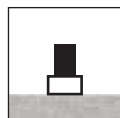

Installazione su muretto Cod. 8146 - 8046
Installation in a low fencing wall

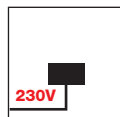

LED
L'apparecchio è fornito completo di alimentatore elettronico 220/240V 50/60Hz posizionato all'interno dell'apparecchio.
The luminaire is supplied with a 220/240V 50/60Hz built-in power supply



IK 07

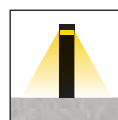

Cod. 8840 - 8841 - 8842

L'emissione di luce verso il basso è nel pieno rispetto delle leggi contro l'inquinamento luminoso.

The direct light emission is in full compliance with standard light pollution directives.

OPTIONAL

Cod. TR 8040

Flangia: accessorio per palo.
Flange: accessory for post.

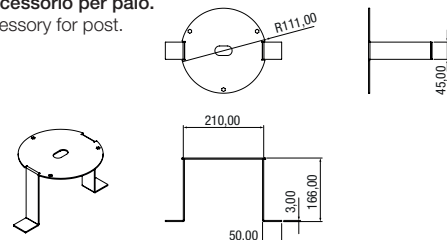

Apparecchio progettato nel rispetto delle leggi contro l'inquinamento luminoso
The luminaire is projected in full compliance with standard light pollution directives



8842 H 400

8842.66X	LED	25W	2850 lm	4000 K
8842.67X	LED	25W	2630 lm	3000 K

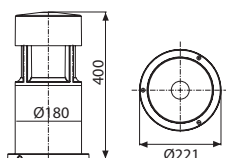

8841 H 700

8841.66X	LED	25W	2850 lm	4000 K
8841.67X	LED	25W	2630 lm	3000 K

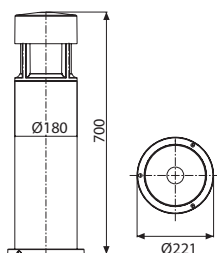

8840 H 1100

8840.66X	LED	25W	2850 lm	4000 K
8840.67X	LED	25W	2630 lm	3000 K

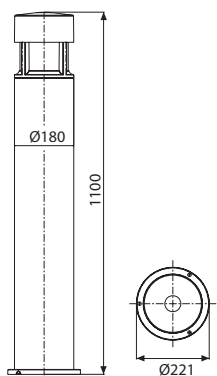

GRETA BIG

GRETA BIG



8146 H 260

Apparecchio a luce indiretta - Vetro trasparente
Indirect light luminaire - Transparent glass

Installazione a muro o su muretto

Wall mounting or on a low fencing wall

8146.00X	LED	15W	E27
8146.66X	LED	25W	2850 lm 4000 K
8146.67X	LED	25W	2630 lm 3000 K

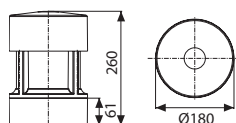

8142 H 400

8142.00X	LED	15W	E27
8142.66X	LED	25W	2850 lm 4000 K
8142.67X	LED	25W	2630 lm 3000 K

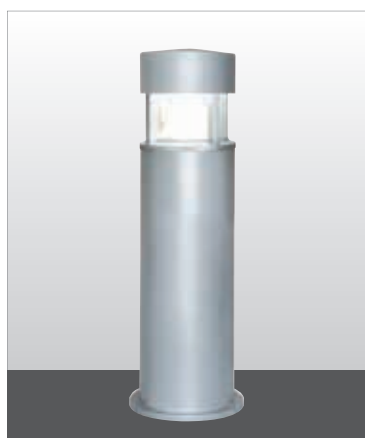
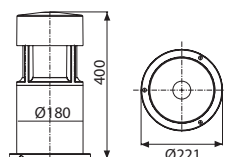

8141 H 700

8141.00X	LED	15W	E27
8141.66X	LED	25W	2850 lm 4000 K
8141.67X	LED	25W	2630 lm 3000 K

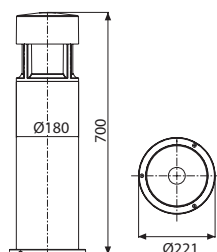

8140 H 1100

8140.00X	LED	15W	E27
8140.66X	LED	25W	2850 lm 4000 K
8140.67X	LED	25W	2630 lm 3000 K

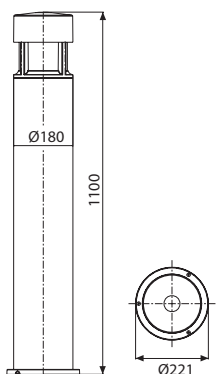

Apparechio a luce diretta - Diffusore in policarbonato
Direct light luminaire - Polycarbonate diffuser

GRETA BIG

GRETA BIG



8046 H 260

8046.00X	LED	15W	E27
8046.66X	LED	12W	1700 lm 4000 K
8046.67X	LED	12W	1700 lm 3000 K

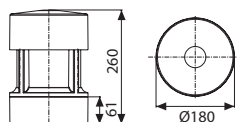

8042 H 400

8042.00X	LED	15W	E27
8042.66X	LED	25W	3700 lm 4000 K
8042.67X	LED	25W	3700 lm 3000 K

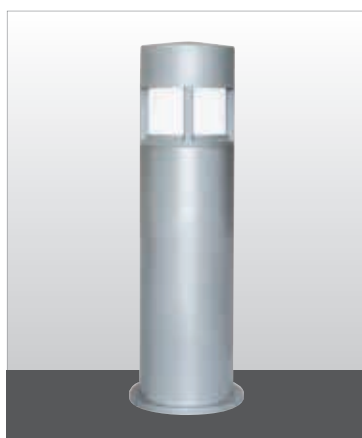
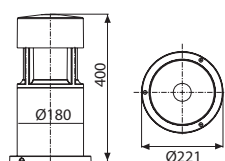

8041 H 700

8041.00X	LED	15W	E27
8041.66X	LED	25W	3700 lm 4000 K
8041.67X	LED	25W	3700 lm 3000 K

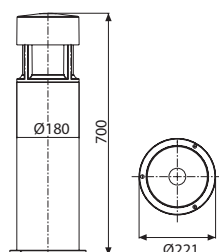

8040 H 1100

8040.00X	LED	15W	E27
8040.66X	LED	25W	3700 lm 4000 K
8040.67X	LED	25W	3700 lm 3000 K

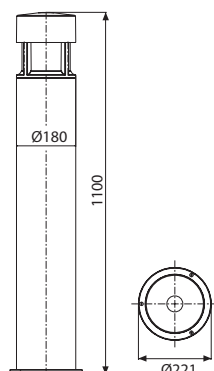





SELECTA
SELECTA STELO



DUNE
DUNE STELO



INTRO
INTRO STELO

SELECTA

Apparecchio per interni ed esterni a parete o a soffitto.
Disponibile in due diverse dimensioni MINI e BIG costituito da:

- Corpo in alluminio pressofuso verniciato
- Diffusore in vetro opale temperato
- Parabola riflettente in alluminio
- Guarnizioni in EPDM e in silicone
- Viti di chiusura in acciaio inox
- Verniciatura in polveri poliestere ad elevata resistenza ai raggi ultravioletti e alla corrosione

Indoor and outdoor wall or ceiling luminaire available in two different dimensions MINI and BIG constructed of:

- Painted die-cast aluminium body
- Tempered opal glass diffuser
- Aluminium reflector
- EPDM and silicon gaskets
- Stainless steel screws
- Painting using high resistance to UV and corrosion polyester powders



Colori - Colours

X=9  Antracite
Anthracite

X=4  Silver

Diffusore - Diffuser

Codice-Code 00 2080 BIG
00 5040 MINI

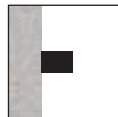

Installazione a parete
Wall mounting



Cod. 2083 - 5043
Installazione a soffitto
Ceiling mounting

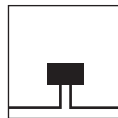

Doppia entrata cavi di alimentazione
Double power supply cables input

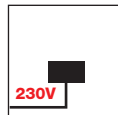

LED

L'apparecchio è fornito completo di alimentatore elettronico 220/240V 50/60Hz posizionato all'interno dell'apparecchio.

The luminaire is supplied with a 220/240V 50/60Hz built-in power supply.



IK 07



2080 BIG
5040 MINI

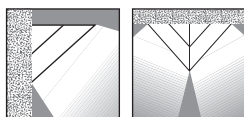

SELECTA BIG

2080.00X	LED	18W	E27	
2080.66X	LED	20W	2350 lm	4000 K
2080.67X	LED	20W	2350 lm	3000 K

SELECTA MINI

5040.00X	LED	12W	E27	
5040.66X	LED	20W	2350 lm	4000 K
5040.67X	LED	20W	2350 lm	3000 K

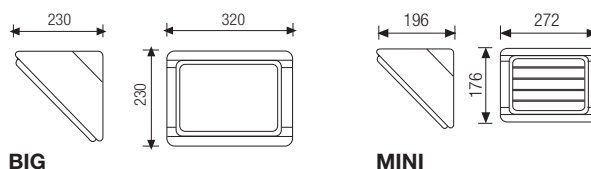

BIG

MINI



2081 BIG
5041 MINI

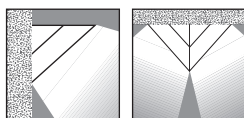

SELECTA BIG

2081.00X	LED	18W	E27	
2081.66X	LED	20W	2350 lm	4000 K
2081.67X	LED	20W	2350 lm	3000 K

SELECTA MINI

5041.00X	LED	12W	E27	
5041.66X	LED	20W	2350 lm	4000 K
5041.67X	LED	20W	2350 lm	3000 K

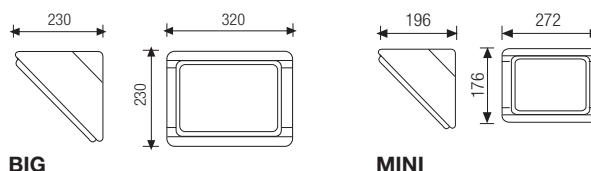

BIG

MINI



2083 BIG
5043 MINI

SELECTA BIG

2083.00X	LED	18W	E27	
2083.66X	LED	20W	2350 lm	4000 K
2083.67X	LED	20W	2350 lm	3000 K

SELECTA MINI

5043.00X	LED	12W	E27	
5043.66X	LED	20W	2550 lm	4000 K
5043.67X	LED	20W	2350 lm	3000 K

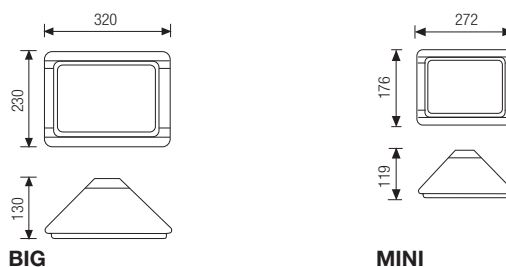

BIG

MINI

SELECTA STELO

Apparecchio da giardino per esterni costituito da:

- Corpo in alluminio pressofuso verniciato
- Diffusore in vetro opale temperato
- Parabola riflettente in alluminio
- Guarnizioni in EPDM e in silicone
- Viti di chiusura in acciaio inox
- Verniciatura in polveri poliestere ad elevata resistenza ai raggi ultravioletti e alla corrosione
- A richiesta supporto per l'installazione CP 20 per SELECTA BIG

Outdoor post garden luminaire constructed of:

- Painted die-cast aluminium body
- Tempered opal glass diffuser
- Aluminium reflector
- EPDM and silicon gaskets
- Stainless steel screws
- Painting using high resistance to UV and corrosion polyester powders
- Installation support CP 20 for SELECTA BIG on request



Colori - Colours

X=9 Antracite
Anthracite

X=4 Silver

Diffusore - Diffuser

Codice-Code 00 2080 BIG
00 5040 MINI

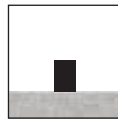

Installazione a terra
Floor mounting

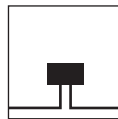

Doppia entrata cavi di alimentazione
Double power supply cables input

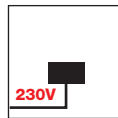

LED
L'apparecchio è fornito completo di alimentatore elettronico 220/240V 50/60Hz posizionato all'interno dell'apparecchio
The luminaire is supplied with a 220/240V 50/60Hz built-in power supply



IK 07

OPTIONAL Cod. CP20

Per/for SELECTA STELO BIG

Flangia: accessorio per palo.

Flange: accessory for post.

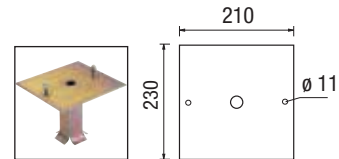

S 90.00X



SELECTA STELO BIG

ACCESSORIO:

Supporto orientabile a doppia installazione in alluminio pressofuso privo di parte elettrica da inserire su palo Ø 60 mm.
Double direction fixing bracket without electrical components suitable for Ø 60 mm post fixing.

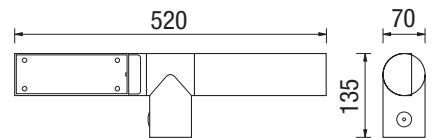

per inserimento palo ø 60
for 60 Ø post fitting

S 80.00X



SELECTA STELO BIG

ACCESSORIO:

Supporto orientabile a installazione singola in alluminio pressofuso privo di parte elettrica da inserire su palo Ø 60 mm.
Mono direction fixing bracket without electrical components suitable for Ø 60 mm post fixing.

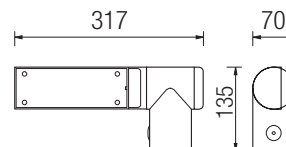



per inserimento palo ø 60
for 60 Ø post fitting





2092 BIG H 1200  griglia / grid
5062 MINI H 1000  griglia / grid



2093 BIG H 1200  anello / ring
5063 MINI H 1000  anello / ring

SELECTA STELO BIG

con griglia / grid

2092.00X	LED	18W	E27
2092.66X	LED	20W	2350 lm 4000 K
2092.67X	LED	20W	2350 lm 3000 K

con anello / ring

2093.00X	LED	18W	E27
2093.66X	LED	20W	2550 lm 4000 K
2093.67X	LED	20W	2350 lm 3000 K

SELECTA STELO MINI

con griglia / grid

5062.00X	LED	12W	E27
5062.66X	LED	20W	2350 lm 4000 K
5062.67X	LED	20W	2350 lm 3000 K

con anello / ring

5063.00X	LED	12W	E27
5063.66X	LED	20W	2350 lm 4000 K
5063.67X	LED	20W	2350 lm 3000 K

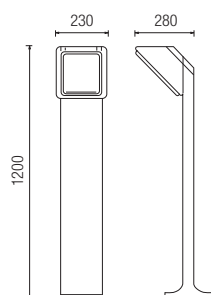

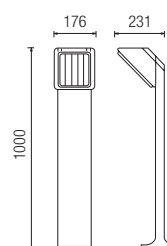

BIG





MINI



2097 BIG H 850  anello / ring
5067 MINI H 650  anello / ring



2096 BIG H 850  griglia / grid
5066 MINI H 650  griglia / grid

SELECTA STELO BIG

con griglia / grid

2096.00X	LED	18W	E27
2096.66X	LED	20W	2350 lm 4000 K
2096.67X	LED	20W	2350 lm 3000 K

con anello / ring

2097.00X	LED	18W	E27
2097.66X	LED	20W	2350 lm 4000 K
2097.67X	LED	20W	2350 lm 3000 K

SELECTA STELO MINI

con griglia / grid

5066.00X	LED	12W	E27
5066.66X	LED	20W	2550 lm 4000 K
5066.67X	LED	20W	2350 lm 3000 K

con anello / ring

5067.00X	LED	12W	E27
5067.66X	LED	20W	2350 lm 4000 K
5067.67X	LED	20W	2350 lm 3000 K

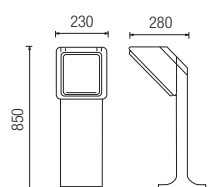

BIG

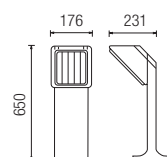

MINI

DUNE

Apparecchio per interni ed esterni costituito da:

- Corpo in alluminio pressofuso verniciato
- Palo in alluminio estruso
- Diffusore in vetro satinato
- Parabola riflettente in alluminio
- Guarnizioni in EPDM
- Viti di chiusura in acciaio inox
- Verniciatura in polveri poliesteri ad elevata resistenza ai raggi ultravioletti e alla corrosione

Indoor and outdoor luminaire constructed of:

- Painted die-cast aluminium body
- Extruded aluminium post
- Internally satin glass diffuser
- Aluminium reflector
- EPDM gaskets
- Stainless steel screws
- Painting using high resistance to UV and corrosion polyester powders



DUNE STELO

Apparecchio per esterni costituito da:

- Corpo in alluminio pressofuso verniciato
- Palo in alluminio estruso verniciato
- Diffusore in vetro

Outdoor post luminaire constructed of:

- Painted die-cast aluminium body
- Painted extruded aluminium post
- Glass diffuser



Colori - Colours

X=9  Antracite
Anthracite

X=4  Silver

Diffusore - Diffuser

Codice-Code 00 5020

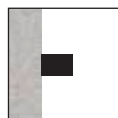

Cod. 5020 - 5030
Installazione a parete
Wall mounting



Cod. 5020
Installazione a soffitto
Ceiling mounting

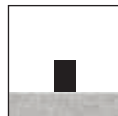

DUNE STELO
Installazione a terra
DUNE POST
Floor mounting

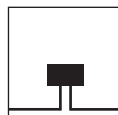

Doppia entrata cavi di alimentazione
Double power supply cables input

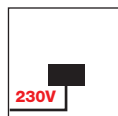

LED
Led a tensione di rete 220/240V 50/60Hz.
Connessione diretta alla rete di alimentazione
senza necessità di alimentatore.
LED's direct operation at 220/240V 50/60Hz.
No power supply is required.

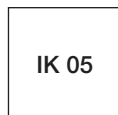

IK 05

OPTIONAL Cod. CP 20

Per/for 5021 - 5022

Flangia: accessorio per palo.

Flange: accessory for post.

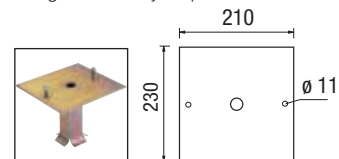

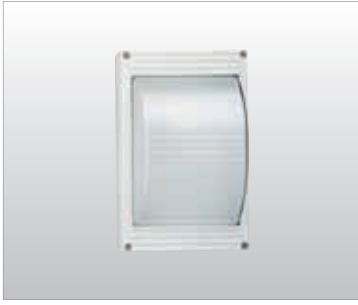

5020

5020.00X	LED	15W	E27	
5020.55X	LED	13W	1790 lm	4000 K
5020.56X	LED	13W	1790 lm	3000 K

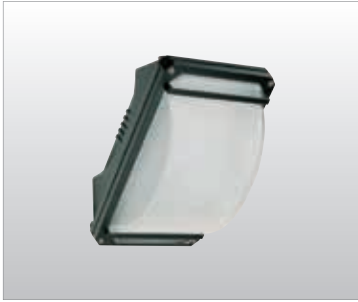
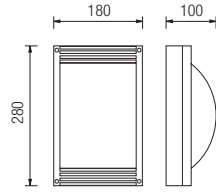

5030

5030.00X	LED	15W	E27	
5030.55X	LED	13W	1790 lm	4000 K
5030.56X	LED	13W	1790 lm	3000 K

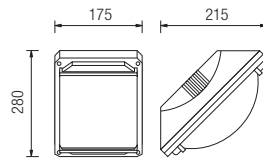

DUNE STELO



5031 H 950

5031.00X	LED	15W	E27	
5031.55X	LED	13W	1790 lm	4000 K
5031.56X	LED	13W	1790 lm	3000 K

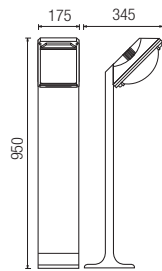

5031



5021 H 980
5022 H 610

5021.00X	LED	15W	E27	
5021.55X	LED	13W	1790 lm	4000 K
5021.56X	LED	13W	1790 lm	3000 K

5022.00X	LED	15W	E27	
5022.55X	LED	13W	1790 lm	4000 K
5022.56X	LED	13W	1790 lm	3000 K

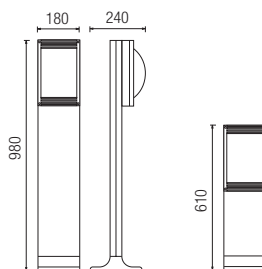

5021

5022

INTRO

Apparecchio a parete per interni ed esterni costituito da:

- Corpo in alluminio pressofuso
- Diffusore in policarbonato
- Guarnizioni in silicone
- Viti di chiusura in acciaio inox
- Verniciatura in polveri poliestere ad elevata resistenza ai raggi ultravioletti e alla corrosione

Indoor and outdoor wall luminaire constructed of:

- Die-cast aluminium body
- Polycarbonate diffuser
- Silicon gaskets
- Stainless steel screws

INTRO STELO

Apparecchio per esterni costituito da:

- Corpo in alluminio pressofuso verniciato
- Palo in alluminio estruso verniciato
- Diffusore in policarbonato

Outdoor post luminaire constructed of:

- Painted die-cast aluminium body
- Painted extruded aluminium post
- Polycarbonate diffuser
- Painting using high resistance to UV and corrosion polyester powders



Colori - Colours

- X=9 Anthracite
X=4 Silver

Diffusore - Diffuser
Codice-Code 08 7040

Gli apparecchi vengono forniti completi di lampadina
Bulb enclosed with the luminaires



Cod. 7041 - 7042
Installazione a parete
Wall mounting

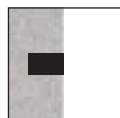

Cod. 7040
Incasto a parete
Recessed wall version

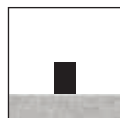

Cod. 7080 - 7081
Installazione a terra
Floor mounting



Cod. 7040
La cassaforma deve essere installata a filo muro
Holder must be recessed flush with the wall surface

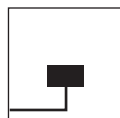

Entrata singola cavi di alimentazione
Single power supply cables input

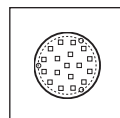

LED Gx53
Non necessita di alcun alimentatore.
It does not need the power supply.



OPTIONAL

Cod. CP 90
Per/for 7080 - 7081
Flangia: accessorio per palo.
Flange: accessory for post.

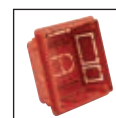
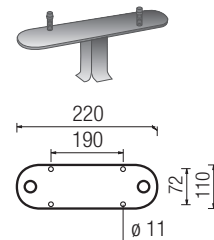

cod. CS 40
per/for 7040
Cassaforma in tecnopolimero 92x92x45 mm
Technopolymer holder 92x92x45 mm





7040

- **7040.68X** LED 6,5W Gx53 650 lm 4000 K
- **7040.69X** LED 6,5W Gx53 650 lm 3000 K

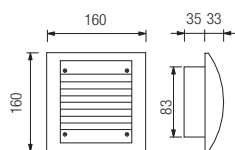

7041

- **7041.68X** LED 6,5W Gx53 650 lm 4000 K
- **7041.69X** LED 6,5W Gx53 650 lm 3000 K

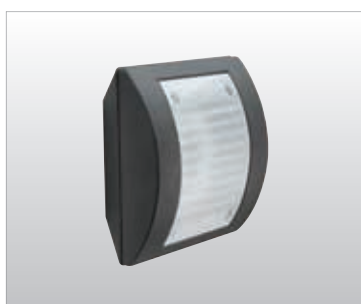
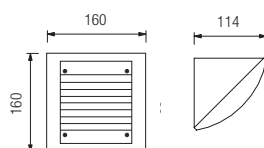

7042

- **7042.68X** LED 6,5W Gx53 650 lm 4000 K
- **7042.69X** LED 6,5W Gx53 650 lm 3000 K

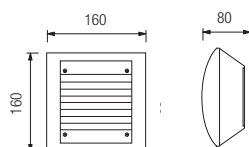

INTRO STELO



7080 H 950 - 7081 H 600

- **7081.68X** LED 6,5W Gx53 650 lm 4000 K
- **7081.69X** LED 6,5W Gx53 650 lm 3000 K
- **7080.68X** LED 6,5W Gx53 650 lm 4000 K
- **7080.69X** LED 6,5W Gx53 650 lm 3000 K

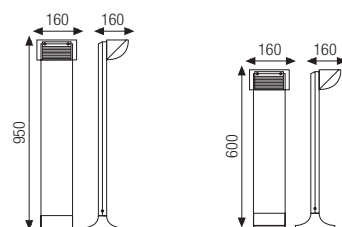

7080

7081

- L'apparecchio viene fornito completo di lampadina
Bulb enclosed with the luminaire





LUNA

LUNA

Apparecchio per illuminazione di esterni a una o a due uscite di luce. È disponibile in due dimensioni Ø 80 e Ø 120 e in diverse altezze costituito da:

- Base e chiusura in alluminio pressofuso verniciato
- Palo in alluminio estruso verniciato
- Diffusore in policarbonato
- Viti di chiusura in acciaio inox
- Verniciatura in polveri poliestere ad elevata resistenza ai raggi ultravioletti e alla corrosione

Outdoor luminaire with 1 or 2 light openings. Available in Ø 80 and Ø 120. Available in different heights constructed of:

- Painted die-cast aluminium base and cap
- Painted extruded aluminium post
- Polycarbonate diffuser
- Stainless steel screws
- Painting using high resistance to UV and corrosion polyester powders



Colori - Colours

X=9  Antracite
Anthracite

X=4  Silver

Diffusore - Diffuser

Codice-Code 08 2610
per/for Cod. 2610 - 2616

Codice-Code 08 2611
per/for Cod. 2611 - 2618

Codice-Code 08 2614
per/for Cod. 2614 - 2615

Codice-Code 08 2612
per/for Cod. 2612 - 2619

Le lampadine vengono fornite solo su richiesta
Bulbs supplied only on request

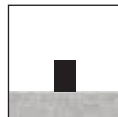

Installazione a terra
Floor mounting

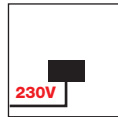

LUNA MINI LED
L'apparecchio è fornito completo di alimentatore elettronico 220/240V 50/60Hz posizionato all'interno dell'apparecchio.
The luminaire is supplied with a 220/240V 50/60Hz built-in power supply.



IK 07



Per/for LUNA MINI
ACCESSORIO: art. CP 26
Supporto orientabile con picchetto in alluminio pressofuso.
Die-cast aluminium directional fixing bracket with spike.



Versione in biemissione
Double-light version



2616 H 830

LED				
2616.66X	LED	16,8W	2x1400 lm	4000 K
2616.67X	LED	16,8W	2x1400 lm	3000 K
2616.99X	 TC-L	24W	2G11	

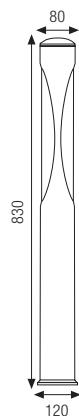

2618 H 530

LED				
2618.66X	LED	16,8W	2x1400 lm	4000 K
2618.67X	LED	16,8W	2x1400 lm	3000 K
2618.98X	 TC-L	18W	2G11	



LUNA MINI

LUNA MINI



2610 H 830

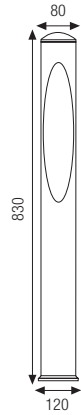

Versione in monoemissione Mono-light version

LED

2610.66X	LED	8,4W	1400 lm	4000 K
2610.67X	LED	8,4W	1400 lm	3000 K
2610.99X	 TC-L	24W	2G11	



2611 H 530

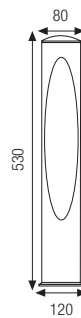

LED

2611.66X	LED	8,4W	1400 lm	4000 K
2611.67X	LED	8,4W	1400 lm	3000 K
2611.98X	 TC-L	18W	2G11	



Versione in biemissione
Double-light version

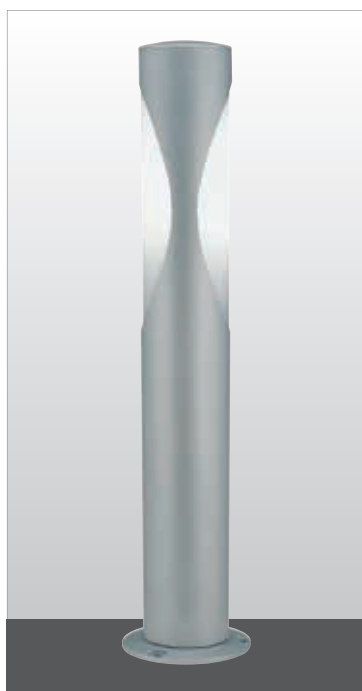

2614 H 1000
2612 H 650

LED				
2614.66X	LED	2x26W	2x1300 lm	4000 K
2614.67X	LED	2x26W	2x1300 lm	3000 K
LED				
2612.66X	LED	2x26W	2x1300 lm	4000 K
2612.67X	LED	2x26W	2x1300 lm	3000 K

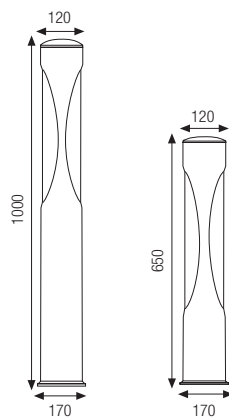

Versione in monoemissione
Mono-light version



2615 H 1000
2619 H 650

LED				
2615.66X	LED	26W	1700 lm	4000 K
2615.67X	LED	26W	1700 lm	3000 K
LED				
2619.66X	LED	26W	1700 lm	4000 K
2619.67X	LED	26W	1700 lm	3000 K

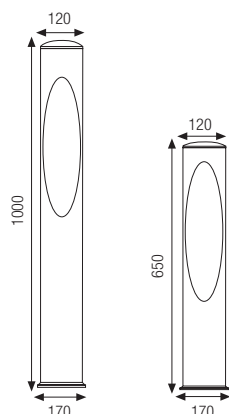



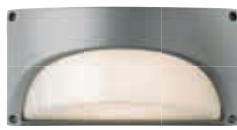

ENCO

ENCO STELO



ENCO

Apparecchio per illuminazione di esterni costituito da:

- Palo in alluminio estruso verniciato
- Struttura superiore in alluminio pressofuso verniciato
- Diffusore in policarbonato
- Parabola riflettente in alluminio
- Guarnizione in silicone
- Viti di chiusura in acciaio inox
- Verniciatura in polveri poliestere ad elevata resistenza ai raggi ultravioletti e alla corrosione

Outdoor luminaire constructed of:

- Painted extruded aluminium post
- Painted die-cast aluminium head
- Polycarbonate diffuser
- Aluminium reflector
- Silicon gasket
- Stainless steel screws
- Painting using high resistance to UV and corrosion polyester powders



ENCO STELO

Apparecchio per esterni costituito da:

- Corpo in alluminio pressofuso verniciato
- Palo in alluminio estruso verniciato
- Diffusore in policarbonato

Outdoor post luminaire constructed of:

- Painted die-cast aluminium body
- Painted extruded aluminium post
- Polycarbonate diffuser



Colori - Colours

X=9  Antracite
Anthracite

X=4  Silver

Diffusore - Diffuser
Codice-Code 08 4080



Cod. 4080
Installazione a parete
Wall mounting

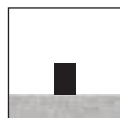

Cod. 4082 - 4086
Installazione a terra
Floor mounting

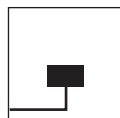

Entrata singola cavi di alimentazione
Single power supply cables input

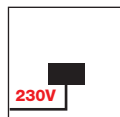

LED
Led a tensione di rete 220/240V 50/60Hz.
Connessione diretta alla rete di alimentazione
senza necessità di alimentatore.
LED's direct operation at 220/240V 50/60Hz.
No power supply is required.

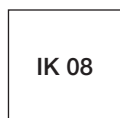

IK 08





4080

4080.00X	LED	8W	E27	
4080.55X	LED	9W	1240 lm	4000 K
4080.56X	LED	9W	1160 lm	3000 K

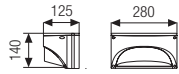

ENCO STELO



4086 H 700
4082 H 1100

4086.00X	LED	8W	E27	
4086.55X	LED	13W	1790 lm	4000 K
4086.56X	LED	13W	1790 lm	3000 K

4082.00X	LED	8W	E27	
4082.55X	LED	13W	1790 lm	4000 K
4082.56X	LED	13W	1790 lm	3000 K

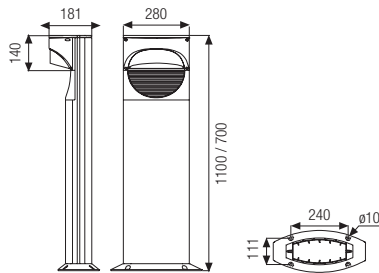





STICK



RAY



STICK

Apparecchio per illuminazione di esterni costituito da:

- Palo in alluminio estruso verniciato
- Diffusore in policarbonato
- Guarnizione in EPDM
- Viti di chiusura in acciaio inox
- Verniciatura in polveri poliestere ad elevata resistenza ai raggi ultravioletti e alla corrosione

Outdoor luminaire constructed of:

- Painted extruded aluminium post
- Polycarbonate diffuser
- EPDM gasket
- Stainless steel screws
- Painting using high resistance to UV and corrosion polyester powders



Colori - Colours

X=9  Antracite
Anthracite

X=4  Silver

Diffusore - Diffuser

Codice-Code **08 3011**
trasparente/trasparent

Codice-Code **07 3011**
opale/opal

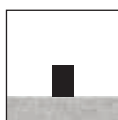

Cod. 3011 - 3015
Installazione a terra
Floor mounting



Cod. 3017
Installazione a muro
Wall mounting

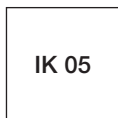



3017

Apparecchio a parete in alluminio pressofuso
Die-cast aluminium wall luminaire

● 3017.91X		TC	11W	G23		
● 3017.05X		LED	9,5W	E27	1055 lm	4000 K
● 3017.06X		LED	9,5W	E27	1055 lm	3000 K

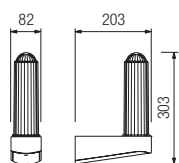

3011 H 550

● 3011.91X		TC	11W	G23		
● 3011.05X		LED	9,5W	E27	1055 lm	4000 K
● 3011.06X		LED	9,5W	E27	1055 lm	3000 K

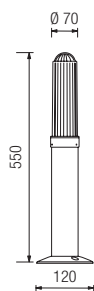

3015 H 1000

● 3015.91X		TC	11W	G23		
● 3015.05X		LED	9,5W	E27	1055 lm	4000 K
● 3015.06X		LED	9,5W	E27	1055 lm	3000 K

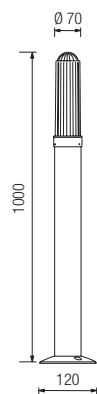

● Lampadina LED inclusa
LED bulb included

● Lampadina 11W inclusa
11W bulb included

RAY

Apparecchio per illuminazione di esterni costituito da:

- Palo in alluminio estruso verniciato
- Struttura superiore in alluminio pressofuso verniciato
- Diffusore in policarbonato
- Guarnizione in silicone
- Viti di chiusura in acciaio inox
- Verniciatura in polveri poliestere ad elevata resistenza ai raggi ultravioletti e alla corrosione

Outdoor luminaire constructed of:

- Painted extruded aluminium post
- Painted die-cast aluminium head
- Polycarbonate diffuser
- Silicon gasket
- Stainless steel screws
- Painting using high resistance to UV and corrosion polyester powders



Colori - Colours

X=3 Nero
Black

X=9 Antracite
Anthracite

X=4 Silver

Diffusore - Diffuser

Codice-Code 08 2810



Cod. 2810 - 2811
Installazione a terra
Floor mounting



Cod. 2812
Installazione a muro
Wall mounting





IK 10







2812

Apparecchio a parete in alluminio pressofuso
Die-cast aluminium wall luminaire

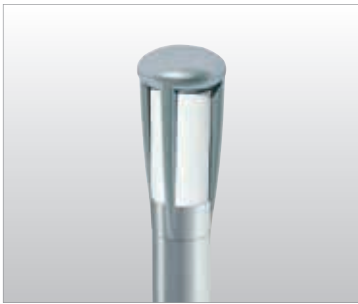
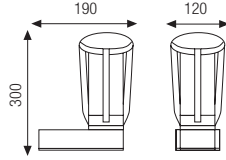
- **2812.05X**  **LED** 9,5W E27 1055 lm 4000 K
- **2812.06X**  **LED** 9,5W E27 1055 lm 3000 K



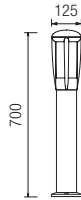

2811 H 700

- **2811.05X**  **LED** 9,5W E27 1055 lm 4000 K
- **2811.06X**  **LED** 9,5W E27 1055 lm 3000 K



2810 H 1000

- **2810.05X**  **LED** 9,5W E27 1055 lm 4000 K
- **2810.06X**  **LED** 9,5W E27 1055 lm 3000 K

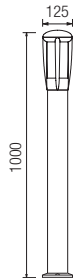

- **L'apparecchio viene fornito completo di lampadina**
Bulb enclosed with the luminaire

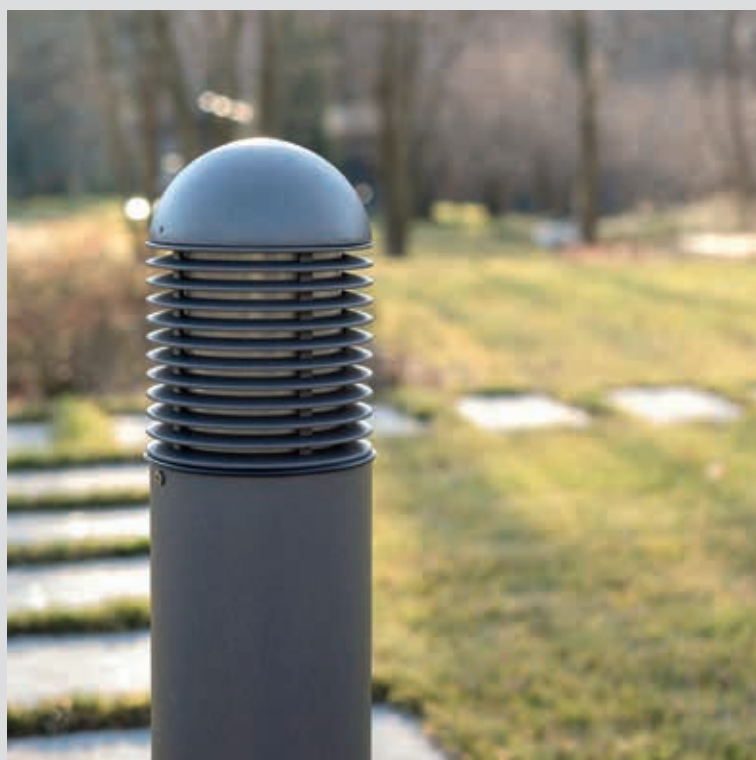



ARGO



ZEUS



ARES



ARES 2



ARES INOX

ARGO

Apparecchio per illuminazione di esterni costituito da:



- Palo in alluminio estruso verniciato
- Struttura superiore in alluminio pressofuso verniciato
- Diffusore in policarbonato
- Guarnizione in silicone
- Viti di chiusura in acciaio inox
- Verniciatura in polveri poliestere ad elevata resistenza ai raggi ultravioletti e alla corrosione

Outdoor luminaire constructed of:

- Painted extruded aluminium post
- Painted die-cast aluminium head
- Polycarbonate diffuser
- Silicon gasket
- Stainless steel screws
- Painting using high resistance to UV and corrosion polyester powders



Colori - Colours

- X=3  Nero
Black
- X=9  Antracite
Anthracite
- X=4  Silver

Diffusore - Diffuser

Codice-Code 08 2100
Policarbonato/Polycarbonate

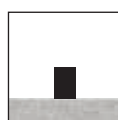

Installazione a terra
Floor mounting

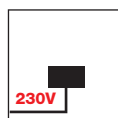

LED
Led a tensione di rete 220/240V 50/60Hz.
Connessione diretta alla rete di alimentazione
senza necessità di alimentatore.
LED's direct operation at 220/240V 50/60Hz.
No power supply is required.



OPTIONAL Cod. CP 27
Flangia: accessorio per palo.
Flange: accessory for post.

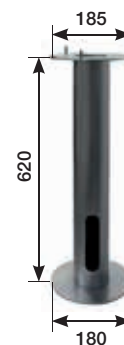



2102 H 550

2102.00X	LED	15W	E27
2102.20X	LED COB	15W	1740 lm 4000 K
2102.21X	LED COB	15W	1670 lm 3000 K

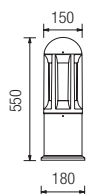

2101 H 710

2101.00X	LED	15W	E27
2101.20X	LED COB	15W	1740 lm 4000 K
2101.21X	LED COB	15W	1670 lm 3000 K

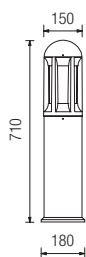

2100 H 1160

2100.00X	LED	15W	E27
2100.20X	LED COB	15W	1740 lm 4000 K
2100.21X	LED COB	15W	1670 lm 3000 K



ZEUS

Apparecchio per illuminazione di esterni costituito da:

- Palo in alluminio estruso verniciato
- Struttura superiore in alluminio pressofuso verniciato
- Diffusore in policarbonato
- Guarnizione in silicone
- Viti di chiusura in acciaio inox
- Verniciatura in polveri poliestere ad elevata resistenza ai raggi ultravioletti e alla corrosione

Outdoor luminaire constructed of:

- Painted extruded aluminium post
- Painted die-cast aluminium head
- Polycarbonate diffuser
- Silicon gasket
- Stainless steel screws
- Painting using high resistance to UV and corrosion polyester powders



Colori - Colours

- X=3** Nero Black
X=9 Antracite Anthracite
X=4 Silver

Diffusore - Diffuser

Codice-Code **08 2000**
Policarbonato/Polycarbonate

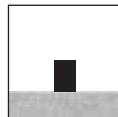

Installazione a terra
Floor mounting

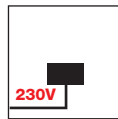

LED
L'apparecchio è fornito completo di alimentatore elettronico 220/240V 50/60Hz posizionato all'interno dell'apparecchio.
The luminaire is supplied with a 220/240V 50/60Hz built-in power supply.



Diffusore policarbonato
Polycarbonate diffuser

OPTIONAL Cod. CP 27
Flangia: accessorio per palo.
Flange: accessory for post.

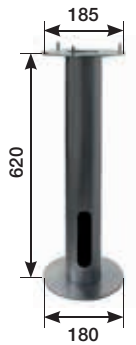

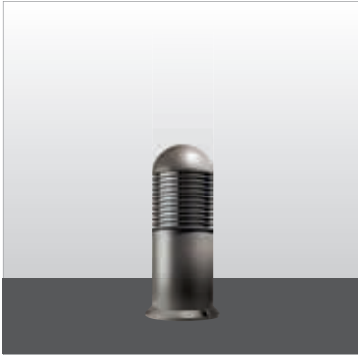

2003 H 500

2003.00X	LED	15W	E27
2003.66X	LED	15W	2300 lm 4000 K
2003.67X	LED	15W	2300 lm 3000 K

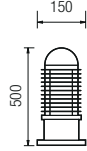

2004 H 650

2004.00X	LED	15W	E27
2004.66X	LED	15W	2300 lm 4000 K
2004.67X	LED	15W	2300 lm 3000 K

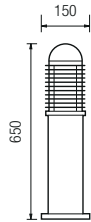

2008 H 1100

2008.00X	LED	15W	E27
2008.66X	LED	15W	2300 lm 4000 K
2008.67X	LED	15W	2300 lm 3000 K



ARES

Apparecchio per illuminazione di esterni costituito da:

- Palo in alluminio estruso verniciato
- Struttura superiore in alluminio pressofuso verniciato
- Diffusore in policarbonato
- Guarnizioni in silicone
- Viti di chiusura in acciaio inox
- Verniciatura in polveri poliestere ad elevata resistenza ai raggi ultravioletti e alla corrosione

Outdoor luminaire constructed of:

- Painted extruded aluminium post
- Painted die-cast aluminium head
- Polycarbonate diffuser
- Silicon gaskets
- Stainless steel screws
- Painting using high resistance to UV and corrosion polyester powders



Colori - Colours

X=3  Nero
Black

X=9  Antracite
Anthracite

X=4  Silver

Diffusore - Diffuser

Codice-Code 08 2000

Policarbonato/Polycarbonate

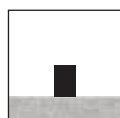

Installazione a terra
Floor mounting

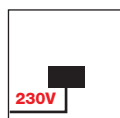

LED
Led a tensione di rete 220/240V 50/60Hz.
Connessione diretta alla rete di alimentazione
senza necessità di alimentatore.
LED's direct operation at 220/240V 50/60Hz.
No power supply is required.



IK 10



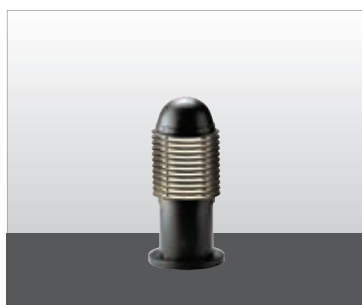

2002 H 500

2002.00X	LED	15W	E27
2002.20X	LED COB	15W	1740 lm 4000 K
2002.21X	LED COB	15W	1670 lm 3000 K

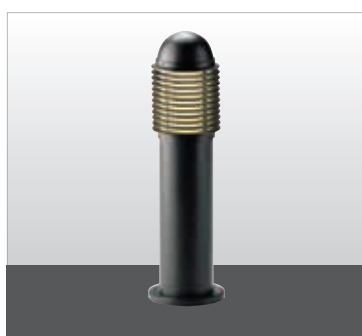
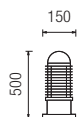

2001 H 650

2001.00X	LED	15W	E27
2001.20X	LED COB	15W	1740 lm 4000 K
2001.21X	LED COB	15W	1670 lm 3000 K

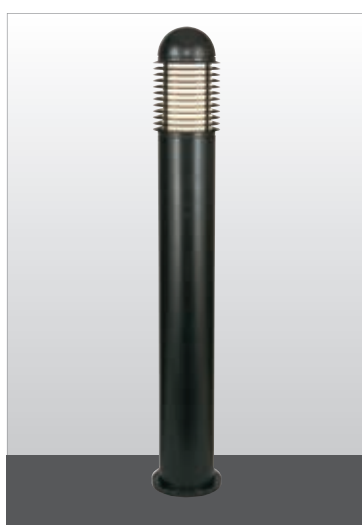
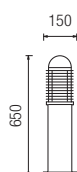

2000 H 1100

2000.00X	LED	15W	E27
2000.20X	LED COB	15W	1740 lm 4000 K
2000.21X	LED COB	15W	1670 lm 3000 K



ARES 2

Apparecchio per illuminazione di esterni costituito da:

- Palo in alluminio estruso verniciato
- Struttura superiore in alluminio pressofuso verniciato
- Puntalino superiore in policarbonato trasparente
- Diffusore in policarbonato
- Guarnizioni in silicone
- Viti di chiusura in acciaio inox
- Verniciatura in polveri poliestere ad elevata resistenza ai raggi ultravioletti e alla corrosione

Outdoor luminaire constructed of:

- Painted extruded aluminium post
- Painted die-cast aluminium head
- Transparent polycarbonate cap
- Polycarbonate diffuser
- Silicon gaskets
- Stainless steel screws
- Painting using high resistance to UV and corrosion polyester powders



Colori - Colours

X=3  Nero Black

X=4  Silver

Diffusore - Diffuser

Codice-Code 08 2000

Policarbonato/Polycarbonate

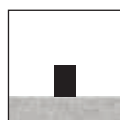

Installazione a terra
Floor mounting

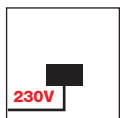

LED

L'apparecchio è fornito completo di alimentatore elettronico 220/240V 50/60Hz posizionato all'interno dell'apparecchio.

The luminaire is supplied with a 220/240V 50/60Hz built-in power supply



OPTIONAL Cod. CP 27

Flangia: accessorio per palo.
Flange: accessory for post.

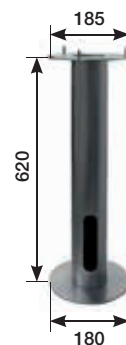

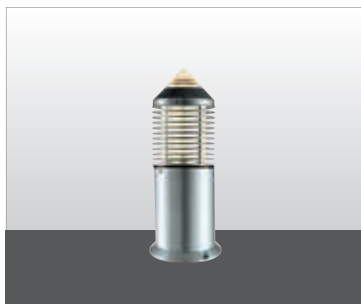

2005 H 530

2005.00X	LED	15W	E27
2005.66X	LED	15W	2300 lm 4000 K
2005.67X	LED	15W	2300 lm 3000 K

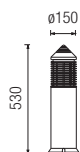

2006 H 670

2006.00X	LED	15W	E27
2006.66X	LED	15W	2300 lm 4000 K
2006.67X	LED	15W	2300 lm 3000 K

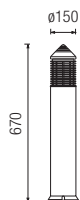

2007 H 1120

2007.00X	LED	15W	E27
2007.66X	LED	15W	2300 lm 4000 K
2007.67X	LED	15W	2300 lm 3000 K



ARES INOX

Apparecchio per illuminazione di esterni costituito da:

- Struttura interamente in acciaio inox AISI 316L
- Diffusore in policarbonato
- Viti di chiusura in acciaio inox

Outdoor luminaire constructed of:

- Entirely stainless steel AISI 316L structure
- Opal polycarbonate diffuser
- Stainless steel screws



Diffusore - Diffuser
Codice-Code 08 2030

Le lampadine vengono fornite solo su richiesta

Bulbs supplied only on request

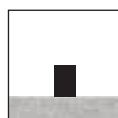

Installazione a terra
Floor mounting

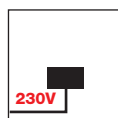

L'apparecchio è fornito completo di alimentatore elettronico 220/240V 50/60Hz posizionato all'interno dell'apparecchio.
The luminaire is supplied with a 220/240V 50/60Hz built-in power supply



IK 07



Versione in biemissione
Double-light version



2031 H 900
2035 H 580
2 aperture
2 opening

LED				
2031.66X	LED	2x13W	2x1200 lm	4000 K
2031.67X	LED	2x13W	2x1100 lm	3000 K
LED				
2035.66X	LED	2x13W	2x1200 lm	4000 K
2035.67X	LED	2x13W	2x1100 lm	3000 K

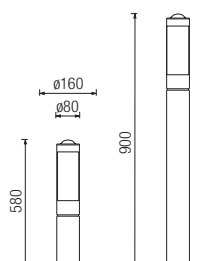

Versione in monoemissione
Mono-light version



2039 H 900
2037 H 580
1 apertura
1 opening

LED				
2039.66X	LED	13W	1200 lm	4000 K
2039.67X	LED	13W	1100 lm	3000 K
LED				
2037.66X	LED	13W	1200 lm	4000 K
2037.67X	LED	13W	1100 lm	3000 K

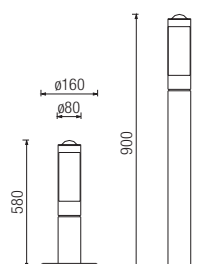





BLOB



BLOB

Apparecchio per illuminazione di esterni a luce diretta o indiretta costituito da:

- Palo in alluminio estruso verniciato
- Struttura superiore in alluminio pressofuso verniciato
- Diffusore in policarbonato opale per Blob e trasparente per Blob 2
- Guarnizioni in silicone
- Viti di chiusura in acciaio inox
- Verniciatura in polveri poliestere ad elevata resistenza ai raggi ultravioletti ed alla corrosione

Outdoor and indoor direct or indirect light luminaire constructed of:

- Painted extruded aluminium post
- Die-cast aluminium painted head
- Opal polycarbonate diffuser for Blob and transparent polycarbonate diffuser for Blob 2
- Silicon gaskets
- Stainless steel screws
- Painting using high resistance to UV and corrosion polyester powders



Colori - Colours

- X=3** Nero Black
- X=9** Antracite Anthracite
- X=4** Silver

Diffusore - Diffuser

Codice-Code 08 8030
per/for Cod. 8030 - 8034

Codice-Code 08 8033
per/for Cod. 8031 - 8032 - 8033

Codice-Code 08 8130
per/for Cod. 8130 - 8134

Codice-Code 08 8133
per/for Cod. 8131 - 8132 - 8133

La serie BLOB viene fornita con lampadine LED
BLOB is supplied with LED bulbs

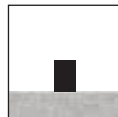

Cod. 8030 - 8034 - 8032 - 8031
8130 - 8131 - 8132 - 8134
Installazione a terra
Floor mounting

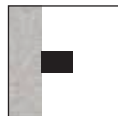

Cod. 8033 - 8133
Installazione a muro
Wall mounting



Apparecchio a luce diretta
Direct light luminaire



Apparecchio a luce indiretta
Indirect light luminaire

Apparecchio a parete
Wall luminaire



8033 - 8133

Diffusore in policarbonato opale / Opal polycarbonate diffuser

- 8033.06X  LED 11W E27

Diffusore in policarbonato trasparente / Transparent polycarbonate diffuser
Apparecchio a luce indiretta / Indirect light luminaire

- 8133.06X  LED 11W E27

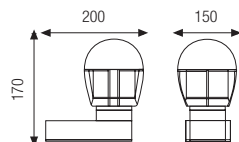

8030 H 1050 - 8034 H 600
8130 H 1050 - 8134 H 600

Diffusore in policarbonato opale / Opal polycarbonate diffuser

- 8034.06X  LED 13W E27

- 8030.06X  LED 13W E27

Diffusore in policarbonato trasparente / Transparent polycarbonate diffuser
Apparecchio a luce indiretta / Indirect light luminaire

- 8130.06X  LED 13W E27

- 8134.06X  LED 13W E27

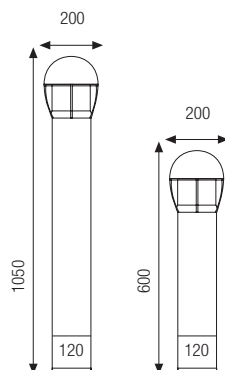

8032 H 900 - 8031 H 600
8132 H 900 - 8131 H 600

Diffusore in policarbonato opale / Opal polycarbonate diffuser

- 8032.06X  LED 11W E27

- 8031.06X  LED 11W E27

Diffusore in policarbonato trasparente / Transparent polycarbonate diffuser
Apparecchio a luce indiretta / Indirect light luminaire

- 8132.06X  LED 11W E27

- 8131.06X  LED 11W E27

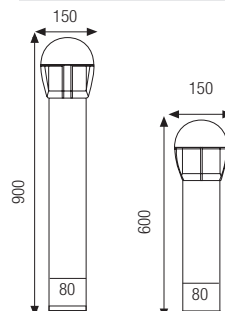

- L'apparecchio viene fornito completo di lampadina
Bulb enclosed with the luminaire





ROSE



AIRONE

AIRONE STELO



AIRONE

Apparecchio per interni ed esterni costituito da:

- Corpo in alluminio pressofuso verniciato
- Diffusore in policarbonato
- Parabola riflettente in alluminio
- Guarnizioni in EPDM
- Viti di chiusura in acciaio inox
- Verniciatura in polveri poliestere ad elevata resistenza ai raggi ultravioletti e alla corrosione

Indoor and outdoor luminaire constructed of:

- Painted die-cast aluminium body
- Polycarbonate diffuser
- Aluminium reflector
- EPDM gaskets
- Stainless steel screws
- Painting using high resistance to UV and corrosion polyester powders



AIRONE STELO

- Palo in alluminio estruso
- Corpo in alluminio pressofuso
- Diffusore in policarbonato
- Su richiesta controbases di fissaggio a terra CP 90

- Extruded aluminium post
- Painted die-cast aluminium structure
- Polycarbonate diffuser
- Root mount for pedestal luminaire ground fixing CP 90 on request



Colori - Colours

- X=9  Antracite
Anthracite
- X=4  Silver

Diffusore - Diffuser

Codice-Code 08 9040
Policarbonato/Polycarbonate

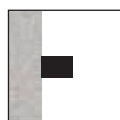

AIRONE
Installazione a parete
Wall mounting

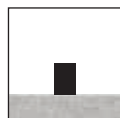

AIRONE STELO
Installazione a terra
Floor mounting

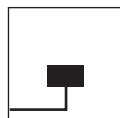

Entrata singola cavi di alimentazione
Single power supply cables input

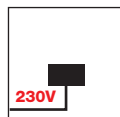

LED
Led a tensione di rete 220/240V 50/60Hz.
Connessione diretta alla rete di alimentazione
senza necessità di alimentatore.
LED's direct operation at 230/240V 50/60Hz.
No power supply is required.



IK 07

OPTIONAL Cod. CP 90
Per/for 9047 - 9048
Flangia: accessorio per palo.
Flange: accessory for post.

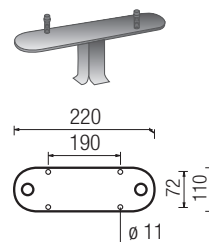



9040

9040.00X	LED	10W	E27	
9040.55X	LED	9W	1240 lm	4000 K
9040.56X	LED	9W	1160 lm	3000 K

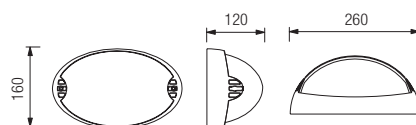

9042

9042.00X	LED	10W	E27	
9042.55X	LED	9W	1240 lm	4000 K
9042.56X	LED	9W	1160 lm	3000 K

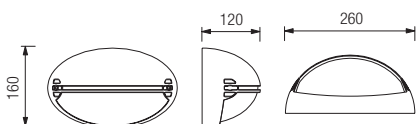

9039

9039.00X	LED	10W	E27	
9039.55X	LED	9W	1240 lm	4000 K
9039.56X	LED	9W	1160 lm	3000 K

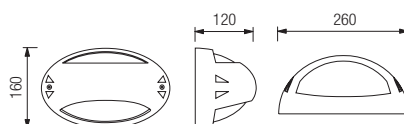

AIRONE

AIRONE



9044

9044.00X	LED	10W	E27	
9044.55X	LED	9W	1240 lm	4000 K
9044.56X	LED	9W	1160 lm	3000 K

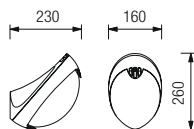

AIRONE STELO

AIRONE STELO



9048 H 1020

9047 H 650

9048.00X	LED	10W	E27	
9048.55X	LED	9W	1240 lm	4000 K
9048.56X	LED	9W	1160 lm	3000 K

9047.00X	LED	10W	E27	
9047.55X	LED	9W	1240 lm	4000 K
9047.56X	LED	9W	1160 lm	3000 K

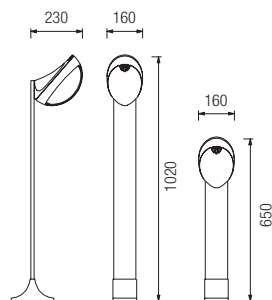



ROSE

Apparecchio da parete per interni ed esterni costituito da:

- Corpo in alluminio pressofuso
- Diffusore in policarbonato satinato
- Parabola riflettente in alluminio
- Guarnizione in silicone
- Viti di chiusura in acciaio inox
- Verniciatura in polveri poliestere ad elevata resistenza ai raggi ultravioletti e alla corrosione

Indoor and outdoor wall luminaire constructed of:

- Die-cast aluminium body
- Satin polycarbonate diffuser
- Aluminium reflector
- Silicon gasket
- Stainless steel screws
- Painting using high resistance to UV and corrosion polyester powders



CL I

IP54

Colori - Colours

X=9  Antracite
Anthracite

X=4  Silver

Diffusore - Diffuser

Codice-Code 08 1618 - 08 1620

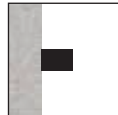

Installazione a parete
Wall mounting

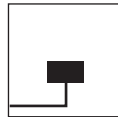

Entrata singola cavi di alimentazione
Single power supply cables input

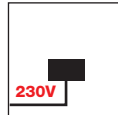

LED
Led a tensione di rete 220/240V 50/60Hz.
Connessione diretta alla rete di alimentazione
senza necessità di alimentatore.
LED's direct operation at 230/240V 50/60Hz.
No power supply is required.

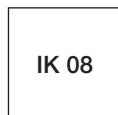

IK 08



1618

1618.00X	LED	8W	E27	
1618.55X	LED	6W	800 lm	4000 K
1618.56X	LED	6W	760 lm	3000 K

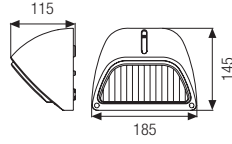

1620

1620.00X	LED	10W	E27	
1620.55X	LED	2x6W	2x800 lm	4000 K
1620.56X	LED	2x6W	2x760 lm	3000 K

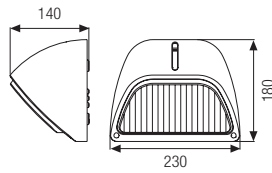





LOOP



STELLA



LEM

LOOP

Apparecchio per interni ed esterni costituito da:

- Corpo in alluminio pressofuso verniciato
- Diffusore in vetro satinato o in policarbonato
- Parabola riflettente in alluminio
- Guarnizioni in EPDM
- Viti di chiusura in acciaio inox
- Verniciatura in polveri poliestere ad elevata resistenza ai raggi ultravioletti e alla corrosione

Indoor and outdoor luminaire constructed of:

- Painted die-cast aluminium structure
- Satin glass or polycarbonate diffuser
- Aluminium reflector
- EPDM gaskets
- Stainless steel screws
- Painting using high resistance to UV and corrosion polyester powders



Colori - Colours

- X=2** Bianco
White
- X=3** Nero
Black
- X=9** Antracite
Anthracite
- X=4** Silver

Diffusore - Diffuser

Codice-Code **00 3081**

Vetro a nido d'ape/Patterned glass
per/for Cod. 8014

Codice-Code **00 859**

Vetro satinato/Satin glass
per/for Cod. 8015

Codice-Code **08 859**

Policarbonato/Polycarbonate
per/for Cod. 8015

Codice-Code **00 1000**

Vetro satinato/Satin glass
per/for Cod. 3087

Codice-Code **08 1000**

Policarbonato/Polycarbonate
per/for Cod. 3087

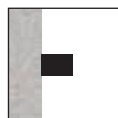

Installazione a parete
Wall mounting



Installazione a soffitto
Ceiling mounting

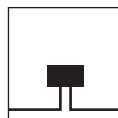

Doppia entrata cavi di alimentazione
Double power supply cables input

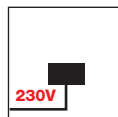

LED - Cod. 8014 - 8015
Led a tensione di rete 230/240V 50/60Hz.
Connessione diretta alla rete di alimentazione
senza necessità di alimentatore.
LED's direct operation at 230/240V 50/60Hz.
No power supply is required.

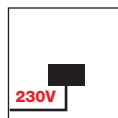

LED - Cod. 3087
L'apparecchio è fornito completo di
alimentatore elettronico 220/240V 50/60Hz
posizionato all'interno dell'apparecchio.
The luminaire is supplied with a 220/240V 50/60Hz
built-in power supply.

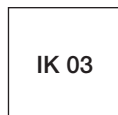

Diffusore vetro
Glass diffuser

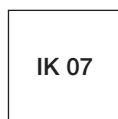

Diffusore policarbonato
Polycarbonate diffuser

- Gli apparecchi della serie Loop sono forniti con diffusore in vetro. Su richiesta sono disponibili anche con diffusore in policarbonato.

Loop series luminaires are supplied with a glass diffuser. Available also with polycarbonate diffuser on request.



8014

Disponibile solo con diffusore in vetro a nido d'ape.
Available only with patterned glass diffuser.

8014.00X	LED	2x12W	E27	
8014.66X	LED	21,6W	2500 lm	4000 K
8014.67X	LED	21,6W	2500 lm	3000 K

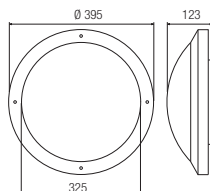

8015

Disponibile con diffusore in vetro satinato o in polycarbonato.
Available with satin glass or polycarbonate diffuser.

8015.00X	LED	2x12W	E27	
8015.66X	LED	21,6W	2500 lm	4000 K
8015.67X	LED	21,6W	2500 lm	3000 K

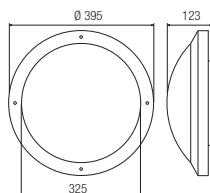

3087

Disponibile con diffusore in vetro satinato o in polycarbonato.
Available with satin glass or polycarbonate diffuser.

3087.00X	LED	10W	E27	
3087.66X	LED	17W	2300 lm	4000 K
3087.67X	LED	17W	2300 lm	3000 K

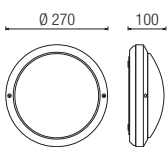

STELLA

Apparecchio per interni ed esterni costituito da:



- Corpo in alluminio pressofuso verniciato
- Diffusore in vetro satinato o policarbonato opale
- Parabola riflettente in alluminio
- Guarnizioni in EPDM
- Viti di chiusura in acciaio inox
- Verniciatura in polveri poliesteri ad elevata resistenza ai raggi ultravioletti e alla corrosione

Indoor and outdoor luminaire constructed of:

- Die-cast aluminium body
- Satin glass or opal polycarbonate diffuser
- Aluminium reflector
- EPDM gaskets
- Stainless steel screws
- Painting using high resistance to UV and corrosion polyester powders



Colori - Colours

- X=2  Bianco
White
- X=9  Antracite
Anthracite
- X=4  Silver

Diffusore - Diffuser

Codice-Code 00 1000
Vetro/Glass

Codice-Code 08 1000
Policarbonato/Polycarbonate

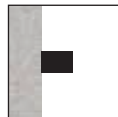

Installazione a parete
Wall mounting



Installazione a soffitto
Ceiling mounting

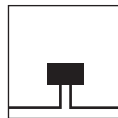

Doppia entrata cavi di alimentazione
Double power supply cables input

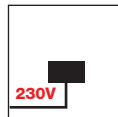

LED
L'apparecchio è fornito completo di alimentatore elettronico 220/240V 50/60Hz posizionato all'interno dell'apparecchio.
The luminaire is supplied with a 220/240V 50/60Hz built-in power supply.

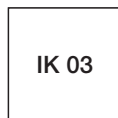

Diffusore vetro
Glass diffuser



Diffusore policarbonato
Polycarbonate diffuser

- **Gli apparecchi della serie Stella sono forniti con diffusore in vetro. Su richiesta sono disponibili anche con diffusore in policarbonato.**

Stella series luminaires are supplied with a glass diffuser. Available also with polycarbonate diffuser on request.



3040

3040.00X	LED	10W	E27
3040.66X	LED	17W	2300 lm 4000 K
3040.67X	LED	17W	2300 lm 3000 K

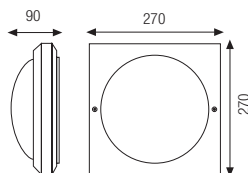

3041

3041.00X	LED	10W	E27
3041.66X	LED	17W	2300 lm 4000 K
3041.67X	LED	17W	2300 lm 3000 K

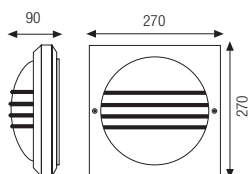

3042

3042.00X	LED	10W	E27
3042.66X	LED	17W	2300 lm 4000 K
3042.67X	LED	17W	2300 lm 3000 K

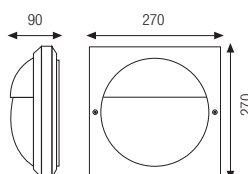

LEM

Apparecchio per interni ed esterni costituito da:

- Corpo in alluminio pressofuso verniciato
- Diffusore in vetro satinato o in policarbonato opale
- Parabola riflettente in alluminio
- Guarnizioni in EPDM
- Viti di chiusura in acciaio inox
- Verniciatura in polveri poliesteri ad elevata resistenza ai raggi ultravioletti e alla corrosione

Indoor and outdoor luminaire constructed of:

- Painted die-cast aluminium structure
- Satin glass or opal polycarbonate diffuser
- Aluminium reflector
- EPDM gaskets
- Stainless steel screws
- Painting using high resistance to UV and corrosion polyester powders



Colori - Colours

- X=2 Bianco
White
- X=3 Nero
Black
- X=9 Antracite
Anthracite
- X=4 Silver

Diffusore - Diffuser

per/for LEM ROUND MINI
Codice-Code 00 861
Vetro/Glass

per/for LEM ROUND
Codice-Code 00 1000
Vetro/Glass

Codice-Code 08 1000
Policarbonato/Polycarbonate

per/for LEM MAXI
Codice-Code 00 859
Vetro/Glass

Codice-Code 08 859
Policarbonato/Polycarbonate

per/for LEM OVAL
Codice-Code 00 1006
Vetro/Glass

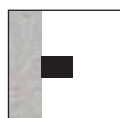

Installazione a parete
Wall mounting



Installazione a soffitto
Ceiling mounting

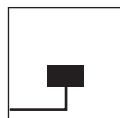

LEM MINI / OVAL
Entrata singola cavi di alimentazione
Single power supply cables input

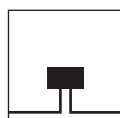

LEM MAXI / ROUND
Doppia entrata cavi di alimentazione
Double power supply cables input

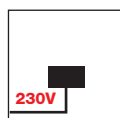

LED - Cod. 1003 - 1004 - 1005 - 1006 - 1007 - 1008
8010 - 8011 - 8012
Led a tensione di rete 230/240V 50/60Hz.
Connessione diretta alla rete di alimentazione
senza necessità di alimentatore.
LED's direct operation at 230/240V 50/60Hz.
No power supply is required.

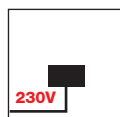

LED - Cod. 1000 - 1001 - 1002
L'apparecchio è fornito completo di
alimentatore elettronico 220/240V 50/60Hz posi-
zionato all'interno dell'apparecchio.
The luminaire is supplied with a 220/240V 50/60Hz
built-in power supply.

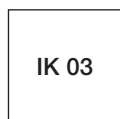

Diffusore vetro
Glass diffuser

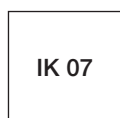

Diffusore policarbonato
Polycarbonate diffuser



1003 Ø 200
1000 Ø 270

Disponibile solo con diffusore in vetro satinato.
Available only with satin glass diffuser.

1003.00X	LED	8W	E27	
1003.45X	LED	8,7W	1120 lm	4000 K
1003.46X	LED	8,7W	1050 lm	3000 K

Disponibile con diffusore in vetro satinato o in polycarbonato.
Available with satin glass or polycarbonate diffuser.

1000.00X	LED	10W	E27	
1000.66X	LED	17W	2300 lm	4000 K
1000.67X	LED	17W	2300 lm	3000 K

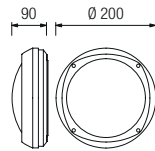

Cod. 1003

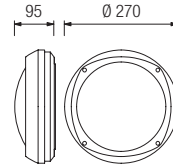

Cod. 1000



1004 Ø 200
1001 Ø 270

Disponibile solo con diffusore in vetro satinato.
Available only with satin glass diffuser.

1004.00X	LED	8W	E27	
1004.45X	LED	8,7W	1120 lm	4000 K
1004.46X	LED	8,7W	1050 lm	3000 K

Disponibile con diffusore in vetro satinato o in polycarbonato.
Available with satin glass or polycarbonate diffuser.

1001.00X	LED	10W	E27	
1001.66X	LED	17W	2300 lm	4000 K
1001.67X	LED	17W	2300 lm	3000 K

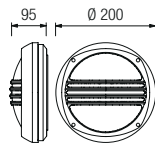

Cod. 1004

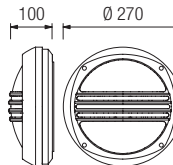

Cod. 1001



1005 Ø 200
1002 Ø 270

Disponibile solo con diffusore in vetro satinato.
Available only with satin glass diffuser.

1005.00X	LED	7W	E27	
1005.45X	LED	8,7W	1120 lm	4000 K
1005.46X	LED	8,7W	1050 lm	3000 K

Disponibile con diffusore in vetro satinato o in polycarbonato.
Available with satin glass or polycarbonate diffuser.

1002.00X	LED	10W	E27	
1002.66X	LED	17W	2300 lm	4000 K
1002.67X	LED	17W	2300 lm	3000 K

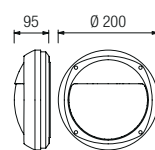

Cod. 1005

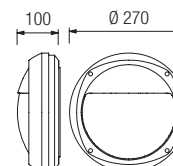

Cod. 1002

LEM MAXI

LEM MAXI



8010

Disponibile con diffusore in vetro satinato o in **polycarbonato**.
Available with satin glass or **polycarbonate** diffuser.

8010.00X	LED	2x12W	E27	
8010.66X	LED	21,6W	2500 lm	4000 K
8010.67X	LED	21,6W	2500 lm	3000 K

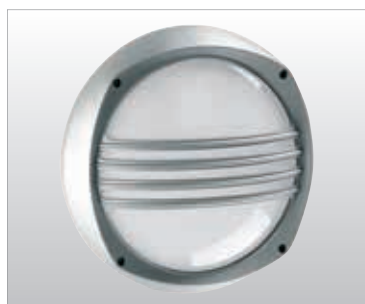
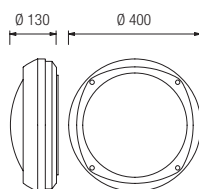

8011

Disponibile con diffusore in vetro satinato o in **polycarbonato**.
Available with satin glass or **polycarbonate** diffuser.

8011.00X	LED	2x12W	E27	
8011.66X	LED	21,6W	2500 lm	4000 K
8011.67X	LED	21,6W	2500 lm	3000 K

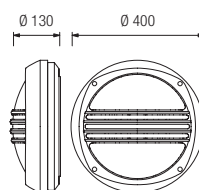

8012

Disponibile con diffusore in vetro satinato o in **polycarbonato**.
Available with satin glass or **polycarbonate** diffuser.

8012.00X	LED	2x12W	E27	
8012.66X	LED	21,6W	2500 lm	4000 K
8012.67X	LED	21,6W	2500 lm	3000 K

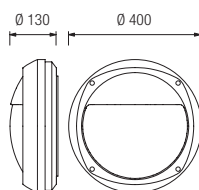



1006

Disponibile solo con diffusore in vetro satinato.
Available only with satin glass diffuser.

1006.00X	LED	10W	E27
1006.55X	LED	13W	1790 lm 4000 K
1006.56X	LED	13W	1790 lm 3000 K

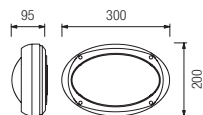

1007

Disponibile solo con diffusore in vetro satinato.
Available only with satin glass diffuser.

1007.00X	LED	10W	E27
1007.55X	LED	13W	1790 lm 4000 K
1007.56X	LED	13W	1790 lm 3000 K

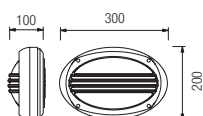

1008

Disponibile solo con diffusore in vetro satinato.
Available only with satin glass diffuser.

1008.00X	LED	10W	E27
1008.55X	LED	13W	1790 lm 4000 K
1008.56X	LED	13W	1790 lm 3000 K

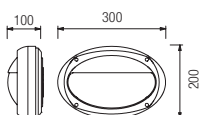





LASER



IDA



ASTRA



REM

LASER

Apparecchio per interni ed esterni
costituito da:





- Corpo in alluminio pressofuso verniciato
- Diffusore in vetro satinato o in policarbonato opale
- Parabola riflettente in alluminio
- Guarnizione in EPDM
- Viti di chiusura in acciaio inox
- Verniciatura in polveri poliestere ad elevata resistenza ai raggi ultravioletti e alla corrosione

Indoor and outdoor luminaire
constructed of:

- Painted die-cast aluminium body
- Satin glass or opal polycarbonate diffuser
- Aluminium reflector
- EPDM gasket
- Stainless steel screws
- Painting using high resistance to UV and corrosion polyester powders



Colori - Colours

- X=2  Bianco
White
- X=3  Nero
Black
- X=9  Antracite
Anthracite
- X=4  Silver

Diffusore - Diffuser

Codice-Code 00 1000
Vetro/Glass

Codice-Code 08 1000
Policarbonato opale
/Opal polycarbonate

Le lampadine vengono fornite
solo su richiesta
Bulbs supplied only on request

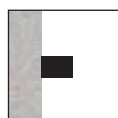

Installazione a parete
Wall mounting

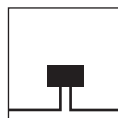

Doppia entrata cavi di alimentazione
Double power supply cables input

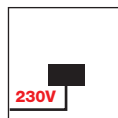

LED
L'apparecchio è fornito completo di
alimentatore elettronico 220/240V 50/60Hz
posizionato all'interno dell'apparecchio
The luminaire is supplied with a 220/240V 50/60Hz
built-in power supply

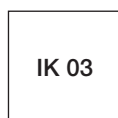

Diffusore vetro
Glass diffuser



Diffusore policarbonato
Polycarbonate diffuser

- Gli apparecchi della serie Laser sono forniti con diffusore in vetro. Su richiesta sono disponibili anche con diffusore in policarbonato.

Laser series luminaires are supplied with a glass diffuser. Available also with polycarbonate diffuser on request.



3082

Lampada a muro - Wall luminaire

3082.00X	LED	10W	E27
3082.96X	TC-D	18W	G24 d-2
3082.66X	LED	17W	2300 lm 4000 K
3082.67X	LED	17W	2300 lm 3000 K

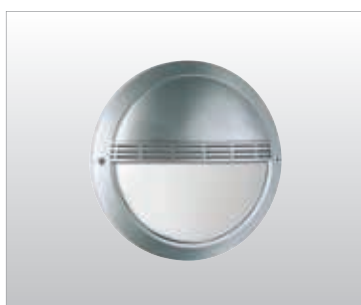
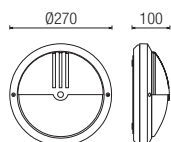

3083

3083.00X	LED	10W	E27
3083.96X	TC-D	18W	G24 d-2
3083.66X	LED	17W	2300 lm 4000 K
3083.67X	LED	17W	2300 lm 3000 K

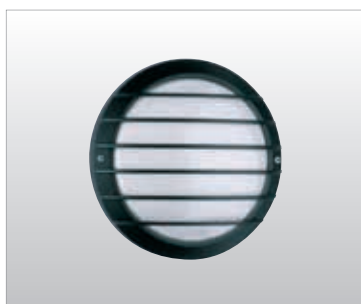
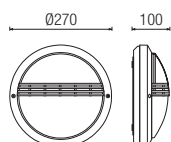

3084

3084.00X	LED	10W	E27
3084.96X	TC-D	18W	G24 d-2
3084.66X	LED	17W	2300 lm 4000 K
3084.67X	LED	17W	2300 lm 3000 K

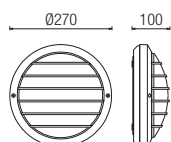

3085

Lampada a muro - Wall luminaire

3085.00X	LED	10W	E27
3085.96X	TC-D	18W	G24 d-2
3085.66X	LED	17W	2300 lm 4000 K
3085.67X	LED	17W	2300 lm 3000 K

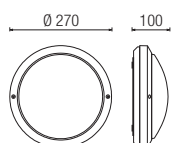

IDA

Apparecchio per interni ed esterni costituito da:

- Corpo in alluminio pressofuso verniciato
- Diffusore in policarbonato opale
- Parabola riflettente in alluminio
- Guarnizione in EPDM
- Viti di chiusura in acciaio inox
- Verniciatura in polveri poliestere ad elevata resistenza ai raggi ultravioletti e alla corrosione

Indoor and outdoor luminaire constructed of:

- Painted die-cast aluminium body
- Opal polycarbonate diffuser
- Aluminium reflector
- EPDM gasket
- Stainless steel screws
- Painting using high resistance to UV and corrosion polyester powders



Colori - Colours

- X=2** Bianco
White
- X=3** Nero
Black
- X=9** Antracite
Anthracite
- X=4** Silver

Diffusore - Diffuser

Codice-Code **08 3090**
Policarbonato opale
/Opal polycarbonate

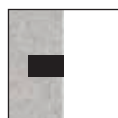

Incasso a parete
Recessed wall version

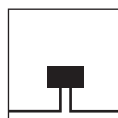

Doppia entrata cavi di alimentazione
Double power supply cables input

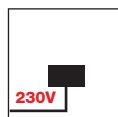

L'apparecchio è fornito completo di alimentatore elettronico 220/240V 50/60Hz posizionato all'interno dell'apparecchio
The luminaire is supplied with a 220/240V 50/60Hz built-in power supply

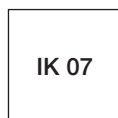

Diffusore policarbonato
Polycarbonate diffuser



Apparecchio ad incasso a parete
Recessed wall luminaire



cod. CS 93
Cassaforma in tecnopolimero da incassare a filo muro prima dell'installazione della lampada
Ø 260 mm - h 60 mm
Technopolymer holder to be recessed flush with the wall before the installation of the luminaire
Ø 260 mm - h 60 mm



3090

Apparecchio ad incasso a parete - Recessed wall luminaire

3090.66X	LED	17W	2300 lm	4000 K
3090.67X	LED	17W	2300 lm	3000 K

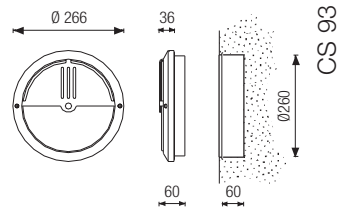

3091

Apparecchio ad incasso a parete - Recessed wall luminaire

3091.66X	LED	17W	2300 lm	4000 K
3091.67X	LED	17W	2300 lm	3000 K

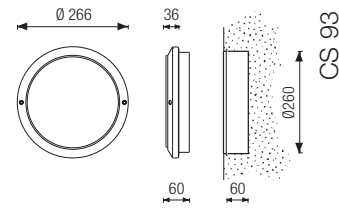

ASTRA

Apparecchio per interni ed esterni costituito da:

- Corpo in alluminio pressofuso verniciato
- Diffusore in vetro satinato oppure policarbonato opale
- Parabola riflettente in alluminio
- Guarnizione in EPDM
- Viti di chiusura in acciaio inox
- A richiesta cassaforma in tecnopolimero per semincasso
- Verniciatura in polveri poliestere ad elevata resistenza ai raggi ultravioletti e alla corrosione

Indoor and outdoor luminaire constructed of:

- Painted die-cast aluminium body
- Satin or opal polycarbonate diffuser
- Aluminium reflector
- EPDM gasket
- Stainless steel screws
- Technopolymer box for semi-recessing on request
- Painting using high resistance to UV and corrosion polyester powders



Colori - Colours

- X=2 Bianco White
- X=3 Nero Black
- X=4 Silver

Diffusore - Diffuser

Codice-Code 00 9380
Vetro/Glass

Codice-Code 08 9380
Policarbonato opale
/Opal polycarbonate

Le lampadine vengono fornite solo su richiesta

Bulbs supplied only on request

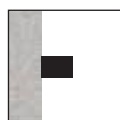

Installazione a parete
Wall mounting

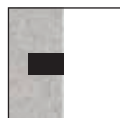

Incasso a parete
Recessed wall version



Cod. 9320 - 9321
Installazione a soffitto
Ceiling mounting

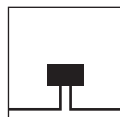

Doppia entrata cavi di alimentazione
Double power supply cables input

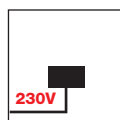

LED
L'apparecchio è fornito completo di alimentatore elettronico 220/240V 50/60Hz posizionato all'interno dell'apparecchio
The luminaire is supplied with a 220/240V 50/60Hz built-in power supply

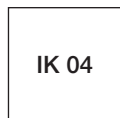

Diffusore vetro
Glass diffuser



Diffusore policarbonato
Polycarbonate diffuser

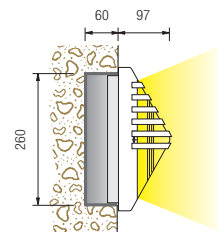

OPTIONAL



cod. CS 93
Cassaforma in tecnopolimero da incassare a filo muro prima dell'installazione della lampada
Ø 260 mm - h 60 mm
Technopolymer holder to be recessed flush with the wall before the installation of the luminaire
Ø 260 mm - h 60 mm





9320

9320.00X	LED	10W	E27
9320.96X	TC-D	18W	G24 d-2
9320.66X	LED	17W	2300 lm 4000 K
9320.67X	LED	17W	2300 lm 3000 K

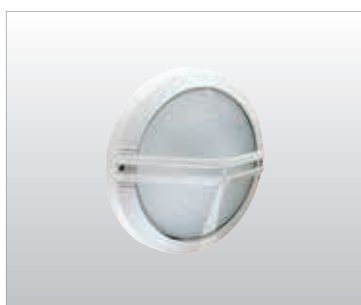
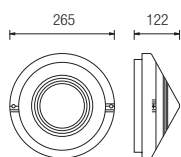

9321

9321.00X	LED	10W	E27
9321.96X	TC-D	18W	G24 d-2
9321.66X	LED	17W	2300 lm 4000 K
9321.67X	LED	17W	2300 lm 3000 K

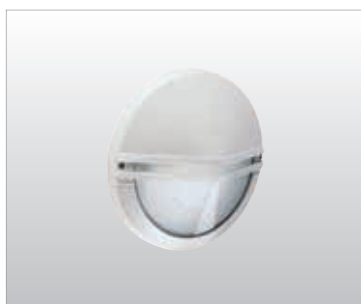
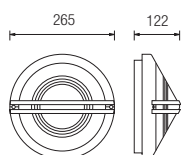

9322

9322.00X	LED	10W	E27
9322.96X	TC-D	18W	G24 d-2
9322.66X	LED	17W	2300 lm 4000 K
9322.67X	LED	17W	2300 lm 3000 K

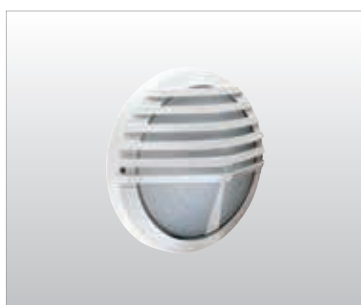
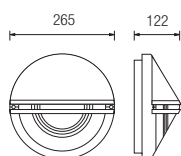

9324

9324.00X	LED	10W	E27
9324.96X	TC-D	18W	G24 d-2
9324.66X	LED	17W	2300 lm 4000 K
9324.67X	LED	17W	2300 lm 3000 K

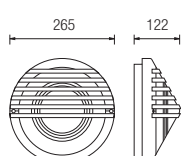

- **Gli apparecchi della serie Astra sono forniti con diffusore in vetro. Su richiesta sono disponibili anche con diffusore in policarbonato.**

Astra series luminaires are supplied with a glass diffuser.
Available also with polycarbonate diffuser on request.

REM

Apparecchio per interni ed esterni costituito da:

- Corpo in alluminio pressofuso verniciato
- Diffusore in vetro satinato
- Parabola riflettente in alluminio
- Guarnizioni in EPDM
- Viti di chiusura in acciaio inox
- Verniciatura in polveri poliestere ad elevata resistenza ai raggi ultravioletti e alla corrosione

Indoor and outdoor luminaire constructed of:

- Painted die-cast aluminium structure
- Satin glass diffuser
- Aluminium reflector
- EPDM gaskets
- Stainless steel screws
- Painting using high resistance to UV and corrosion polyester powders



Colori - Colours

X=2 Bianco White

X=3 Nero Black

X=4 Silver

Diffusore - Diffuser

Codice-Code 00 1060

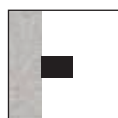

Installazione a parete
Wall mounting

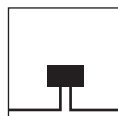

Doppia entrata cavi di alimentazione
Double power supply cables input

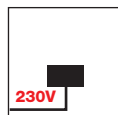

L'apparecchio è fornito completo di alimentatore elettronico 220/240V 50/60Hz posizionato all'interno dell'apparecchio.
The luminaire is supplied with a 220/240V 50/60Hz built-in power supply



IK 03



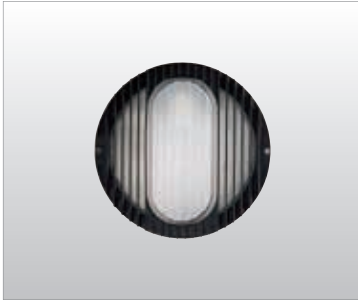

1060

1060.00X	LED	10W	E27	
1060.66X	LED	17W	2500 lm	4000 K
1060.67X	LED	17W	2500 lm	3000 K

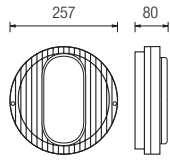

1061

1061.00X	LED	10W	E27	
1061.66X	LED	17W	2500 lm	4000 K
1061.67X	LED	17W	2500 lm	3000 K

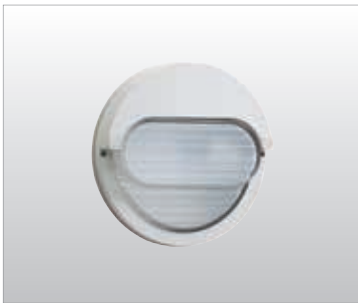
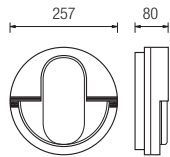

1062

1062.00X	LED	10W	E27	
1062.66X	LED	17W	2500 lm	4000 K
1062.67X	LED	17W	2500 lm	3000 K

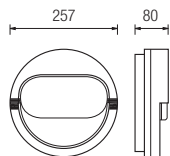





IBIS



KAPPA

IBIS STELO



IBIS

Apparecchio da parete per interni ed esterni costituito da:

- Corpo in alluminio pressofuso
- Diffusore in vetro satinato o in policarbonato
- Parabola riflettente in alluminio
- Guarnizione in EPDM
- Viti di chiusura in acciaio inox
- Verniciatura in polveri poliestere ad elevata resistenza ai raggi ultravioletti e alla corrosione

Indoor and outdoor wall luminaire constructed of:

- Die-cast aluminium body
- Satin or polycarbonate glass diffuser
- Aluminium reflector
- EPDM gasket
- Stainless steel screws
- Painting using high resistance to UV and corrosion polyester powders



IBIS STELO

Apparecchio da giardino costituito da:

- Corpo in alluminio pressofuso
- Palo in alluminio estruso

Garden post luminaire constructed of:

- Die-cast aluminium body
- Extruded aluminium post



IP44 9020 - 9021

Colori - Colours

X=2 Bianco White

X=3 Nero Black

Diffusore - Diffuser

Codice-Code 00 4000

Vetro ovale/Oval glass

Codice-Code 08 4020

Policarbonato ovale/
Oval polycarbonate

Codice-Code 00 860

Vetro tondo/Round glass

Codice-Code 08 3020

Policarbonato tondo/
Round polycarbonate

Codice-Code 00 861

Vetro/ Glass

per/for Cod. 9010

Le lampadine vengono fornite solo su richiesta

Bulbs supplied only on request

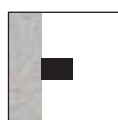

Installazione a parete
Wall mounting

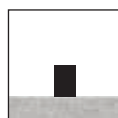

Per/for Cod. 9020 - 9021
Installazione a terra
Floor mounting

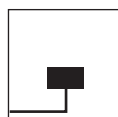

Entrata singola cavi di alimentazione
Single power supply cables input

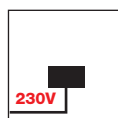

LED
Led a tensione di rete 220/240V 50/60Hz.
Connessione diretta alla rete di alimentazione
senza necessità di alimentatore.
LED's direct operation at 220/240V 50/60Hz.
No power supply is required.

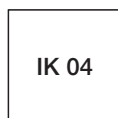

Diffusore vetro
Glass diffuser



Diffusore policarbonato
Polycarbonate diffuser

- Gli apparecchi della serie Ibis sono forniti con diffusore in vetro. Su richiesta sono disponibili anche con diffusore in policarbonato.

Ibis series luminaires are supplied with a glass diffuser. Available also with polycarbonate diffuser on request.

OPTIONAL Cod. CP 90

Per/for 9020 - 9021

Flangia: accessorio per palo.

Flange: accessory for post.

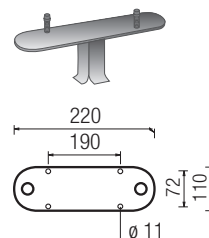



9000

9000.00X	LED	10W	E27
9000.96X	TC-D	18W	G24 d-2
9000.55X	LED	13W	1790 lm 4000 K
9000.56X	LED	13W	1790 lm 3000 K

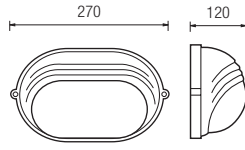

9001

9001.00X	LED	10W	E27
9001.96X	TC-D	18W	G24 d-2
9001.55X	LED	13W	1790 lm 4000 K
9001.56X	LED	13W	1790 lm 3000 K

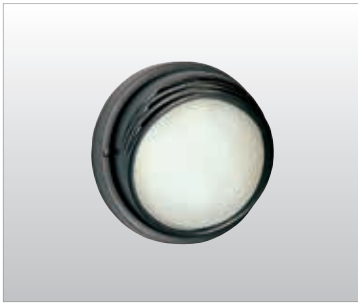
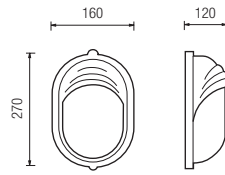

9010 Ø 190

9008 Ø 240

Solo con diffusore in vetro
Only with glass diffuser

9010.00X	LED	8W	E27
9010.45X	LED	8,7W	1120 lm 4000 K
9010.46X	LED	8,7W	1050 lm 3000 K

9008.00X	LED	10W	E27
9008.96X	TC-D	18W	G24 d-2
9008.66X	LED	17W	2500 lm 4000 K
9008.67X	LED	17W	2500 lm 3000 K

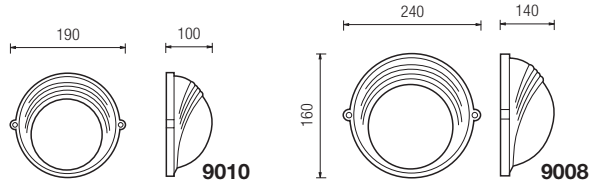

9021 H 960

9020 H 550

9021.00X	LED	10W	E27
9021.96X	TC-D	18W	G24 d-2
9021.55X	LED	13W	1790 lm 4000 K
9021.56X	LED	13W	1790 lm 3000 K

9020.00X	LED	10W	E27
9020.96X	TC-D	18W	G24 d-2
9020.55X	LED	13W	1790 lm 4000 K
9020.56X	LED	13W	1790 lm 3000 K

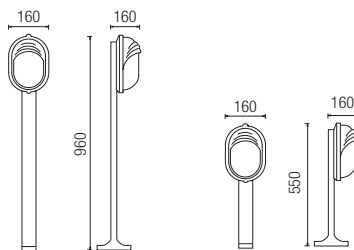

9021

9020

KAPPA

Apparecchio da parete o da soffitto per interni ed esterni costituito da:

- Corpo in alluminio pressofuso verniciato
- Diffusore in vetro satinato
- Guarnizione in EPDM
- Viti di chiusura in acciaio inox
- Verniciatura in polveri poliestere ad elevata resistenza ai raggi ultravioletti e alla corrosione

Indoor and outdoor wall or ceiling luminaire constructed of:

- Painted die-cast aluminium body
- Satin glass diffuser
- EPDM gasket
- Stainless steel screws
- Painting using high resistance to UV and corrosion polyester powders



Colori - Colours

X=2 Bianco White

X=3 Nero Black

X=4 Silver

Diffusore - Diffuser

Codice-Code 00 9030

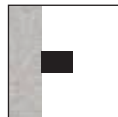

Installazione a parete
Wall mounting



Installazione a soffitto
Ceiling mounting

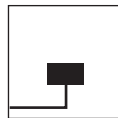

Entrata singola cavi di alimentazione
Single power supply cables input

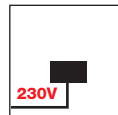

LED

Led a tensione di rete 220/240V 50/60Hz.
Connessione diretta alla rete di alimentazione
senza necessità di alimentatore.

LED's direct operation at 220/240V 50/60Hz.
No power supply is required.

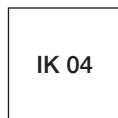

IK 04

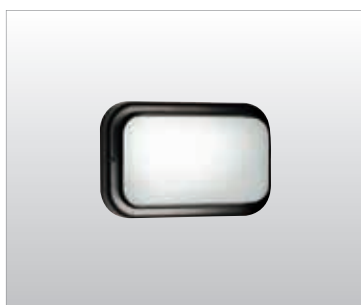

9030

9030.00X	LED	8W	E27	
9030.55X	LED	9W	1240 lm	4000 K
9030.56X	LED	9W	1160 lm	3000 K

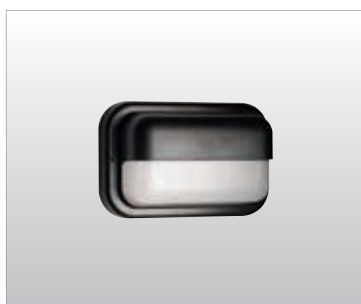
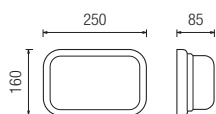

9031

9031.00X	LED	8W	E27	
9031.55X	LED	9W	1240 lm	4000 K
9031.56X	LED	9W	1160 lm	3000 K

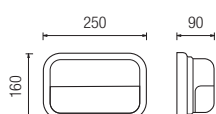

9032

9032.00X	LED	8W	E27	
9032.55X	LED	9W	1240 lm	4000 K
9032.56X	LED	9W	1160 lm	3000 K

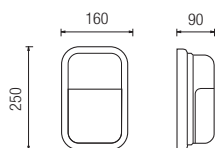

9033

9033.00X	LED	8W	E27	
9033.55X	LED	9W	1240 lm	4000 K
9033.56X	LED	9W	1160 lm	3000 K

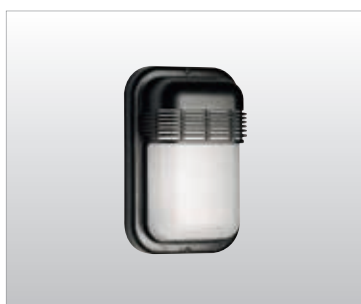
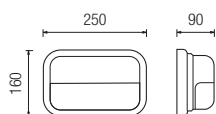

9034

9034.00X	LED	8W	E27	
9034.55X	LED	9W	1240 lm	4000 K
9034.56X	LED	9W	1160 lm	3000 K

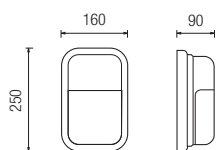





ALFA



DELTA



IRON

ALFA

Apparecchio per interni ed esterni costituito da:

- Corpo in alluminio pressofuso verniciato
- Diffusore in vetro satinato o in policarbonato opale
- Parabola riflettente in alluminio
- Guarnizione in EPDM
- Viti di chiusura in acciaio inox
- Verniciatura in polveri poliesteri ad elevata resistenza ai raggi ultravioletti e alla corrosione

Indoor and outdoor luminaire constructed of:

- Painted die-cast aluminium body
- Opal polycarbonate or satin glass diffuser
- Aluminium reflector
- EPDM gasket
- Stainless steel screws
- Painting using high resistance to UV and corrosion polyester powders



Sheraton Hotel - Doha - QATAR



ALFA ROUND / OVAL

Colori - Colours

- X=2 Bianco
White
- X=3 Nero
Black
- X=4 Silver

ALFA

Colori - Colours

- X=2 Bianco
White
- X=3 Nero
Black

Le lampadine vengono fornite solo su richiesta

Bulbs supplied only on request



Installazione a parete
Wall mounting



Installazione a soffitto
Ceiling mounting

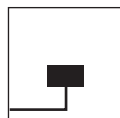

Entrata singola cavi di alimentazione
Single power supply cables input

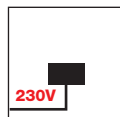

LED - Cod. 3012 - 4000 - 4001 - 4020 - 4021
4022 - 4023 - 4913

Led a tensione di rete 230/240V 50/60Hz.
Connessione diretta alla rete di alimentazione
senza necessità di alimentatore.

LED's direct operation at 230/240V 50/60Hz.
No power supply is required.

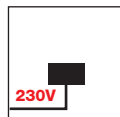

LED - Cod. 3020 - 3021 - 3022 - 3905

L'apparecchio è fornito completo di alimentatore elettronico 220/240V 50/60Hz
posizionato all'interno dell'apparecchio.

The luminaire is supplied with a 220/240V 50/60Hz
built-in power supply.

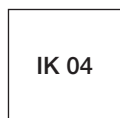

Diffusore vetro
Glass diffuser

IK 04



Diffusore policarbonato
Polycarbonate diffuser

IK 10

- Gli apparecchi della serie Alfa sono forniti con diffusore in vetro.
Su richiesta sono disponibili anche con diffusore in policarbonato.

Alfa series luminaires are supplied with a glass diffuser.
Available also with polycarbonate diffuser on request.





3020

3020.00X	LED	10W	E27
3020.96X	 TC-D	18W	G24 d-2
3020.66X	LED	17W	2500 lm 4000 K
3020.67X	LED	17W	2500 lm 3000 K

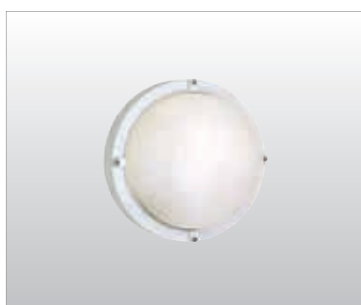
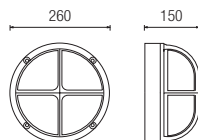

3021

3021.00X	LED	10W	E27
3021.96X	 TC-D	18W	G24 d-2
3021.66X	LED	17W	2500 lm 4000 K
3021.67X	LED	17W	2500 lm 3000 K

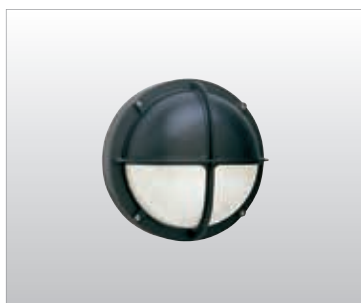
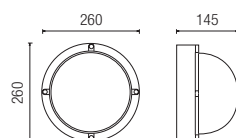

3022

3022.00X	LED	10W	E27
3022.96X	 TC-D	18W	G24 d-2
3022.66X	LED	17W	2500 lm 4000 K
3022.67X	LED	17W	2500 lm 3000 K

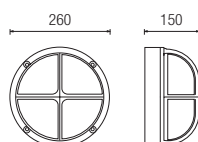

Diffusore - Diffuser

Codice-Code 00 860 Vetro/Glass

Codice-Code 08 3020 Polic. OP/Polyc.OP





4020

4020.00X	LED	10W	E27
4020.96X	TC-D	18W	G24 d-2
4020.95X	TC-D	26W	G24 d-3
4020.66X	LED	13W	1790 lm 4000 K
4020.67X	LED	13W	1790 lm 3000 K

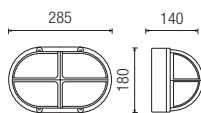

4021

4021.00X	LED	10W	E27
4021.96X	TC-D	18W	G24 d-2
4021.95X	TC-D	26W	G24 d-3
4021.66X	LED	13W	1790 lm 4000 K
4021.67X	LED	13W	1790 lm 3000 K

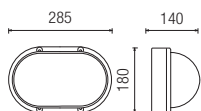

4022

4022.00X	LED	10W	E27
4022.96X	TC-D	18W	G24 d-2
4022.95X	TC-D	26W	G24 d-3
4022.66X	LED	13W	1790 lm 4000 K
4022.67X	LED	13W	1790 lm 3000 K

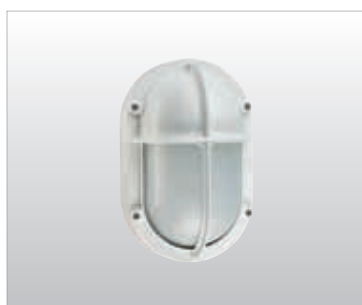
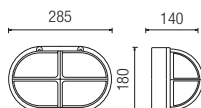

4023

4023.00X	LED	10W	E27
4023.96X	TC-D	18W	G24 d-2
4023.95X	TC-D	26W	G24 d-3
4023.66X	LED	13W	1790 lm 4000 K
4023.67X	LED	13W	1790 lm 3000 K

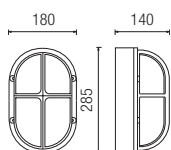

Diffusore - Diffuser

Codice-Code 00 4000 Vetro/Glass

Codice-Code 08 4020 Polic. OP/Polyc.OP

ALFA



4000

4000.00X	LED	10W	E27	
4000.96X	 TC-D	18W	G24 d-2	
4000.66X	LED	13W	1790 lm	4000 K
4000.67X	LED	13W	1790 lm	3000 K

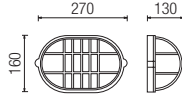

4001

4001.00X	LED	10W	E27	
4001.96X	 TC-D	18W	G24 d-2	
4001.66X	LED	13W	1790 lm	4000 K
4001.67X	LED	13W	1790 lm	3000 K

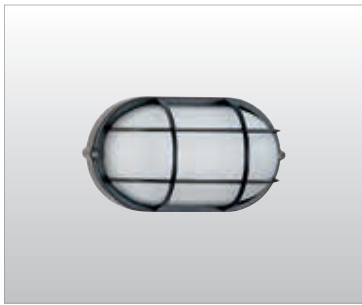
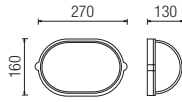

4913

4913.00X	LED	10W	E27	
4913.96X	 TC-D	18W	G24 d-2	
4913.66X	LED	13W	1790 lm	4000 K
4913.67X	LED	13W	1790 lm	3000 K

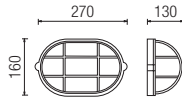

Diffusore - Diffuser

Codice-Code 00 4000 Vetro / Glass

Codice-Code 08 4020 Polic. OP / Polyc. OP



3000

3000.00X	LED	10W	E27
3000.96X	TC-D	18W	G24 d-2

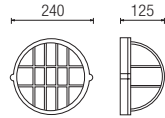

3001 Ø 240

3001.00X	LED	10W	E27
3001.96X	TC-D	18W	G24 d-2

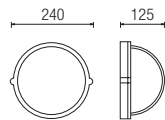

3012 Ø 190

3012.00X	LED	8W	E27
3012.45X	LED	8,7W	1120 lm 4000 K
3012.46X	LED	8,7W	1050 lm 3000 K

Solo con diffusore in vetro
Only with glass diffuser

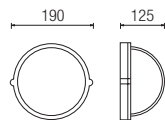

3905

3905.00X	LED	10W	E27
3905.96X	TC-D	18W	G24 d-2
3905.66X	LED	17W	2500 lm 4000 K
3905.67X	LED	17W	2500 lm 3000 K

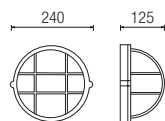

Diffusore - Diffuser

Codice-Code	00 860	per/for	Cod. 3000 - 3001	Vetro/Glass
Codice-Code	08 3020	per/for	Cod. 3000 - 3001	Polic. OP/Polyc.OP
Codice-Code	00 905	per/for	Cod. 3905	Vetro/Glass
Codice-Code	00 861	per/for	Cod. 3012	Vetro/Glass

DELTA

Apparecchio per interni ed esterni costituito da:

- Corpo in alluminio pressofuso verniciato
- Diffusore in vetro satinato o in policarbonato opale
- Parabola riflettente in alluminio
- Guarnizione in EPDM
- Viti di chiusura in acciaio inox
- Verniciatura in polveri poliesteri ad elevata resistenza ai raggi ultravioletti e alla corrosione

Indoor and outdoor luminaire constructed of:

- Painted die-cast aluminium body
- Opal polycarbonate or satin glass diffuser
- Aluminium reflector
- EPDM gasket
- Stainless steel screws
- Painting using high resistance to UV and corrosion polyester powders



Colori - Colours

- X=2 Bianco White
 X=3 Nero Black

Le lampadine vengono fornite solo su richiesta
 Bulbs supplied only on request



Installazione a parete
 Wall mounting

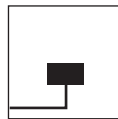

Entrata singola cavi di alimentazione
 Single power supply cables input

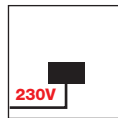

LED
 Led a tensione di rete 230/240V 50/60Hz.
 Connessione diretta alla rete di alimentazione senza necessità di alimentatore.
 LED's direct operation at 230/240V 50/60Hz.
 No power supply is required.



Diffusore vetro
 Glass diffuser



Diffusore policarbonato
 Polycarbonate diffuser

- **Gli apparecchi della serie Delta sono forniti con diffusore in vetro. Su richiesta sono disponibili anche con diffusore in policarbonato.**

Delta series luminaires are supplied with a glass diffuser. Available also with polycarbonate diffuser on request.

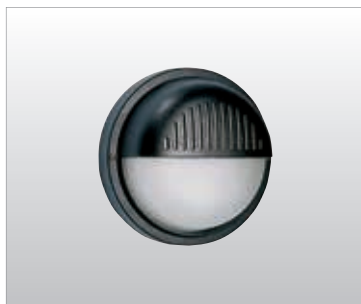

9011 Ø 190

Solo con diffusore in vetro Cod. 00 861
Only with glass diffuser

9011.00X	LED	8W	E27	
9011.45X	LED	8,7W	1120 lm	4000 K
9011.46X	LED	8,7W	1050 lm	3000 K

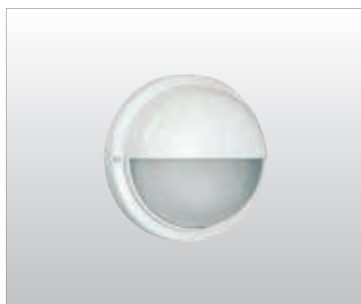
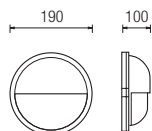

9014 Ø 190

Solo con diffusore in vetro Cod. 00 861
Only with glass diffuser

9014.00X	LED	8W	E27	
9014.45X	LED	8,7W	1120 lm	4000 K
9014.46X	LED	8,7W	1050 lm	3000 K

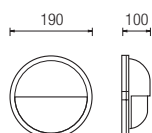

9035

9035.00X	LED	10W	E27	
9035.96X	 TC-D	18W	G24 d-2	
9035.66X	LED	13W	1790 lm	4000 K
9035.67X	LED	13W	1790 lm	3000 K

Diffusore in vetro Cod. 00 4000
Glass diffuser

Diffusore in polic. Cod. 08 4020
Polyc. diffuser

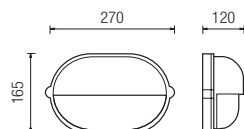

9037

9037.00X	LED	10W	E27	
9037.96X	 TC-D	18W	G24 d-2	
9037.66X	LED	13W	1790 lm	4000 K
9037.67X	LED	13W	1790 lm	3000 K

Diffusore in vetro Cod. 00 913
Glass diffuser

Diffusore in polic. Cod. 08 4020
Polyc. diffuser

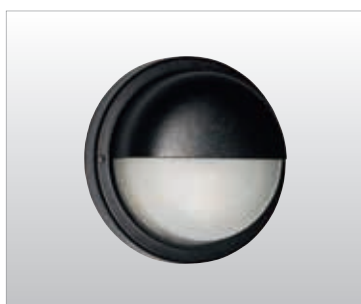
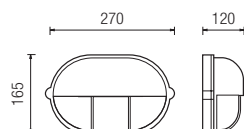

9036 Ø 255

9036.00X	LED	10W	E27	
9036.96X	 TC-D	18W	G24 d-2	
9036.45X	LED	17,6W	2270 lm	4000 K
9036.46X	LED	17,6W	2125 lm	3000 K

Diffusore in vetro Cod. 00 860
Glass diffuser

Diffusore in polic. Cod. 08 3020
Polyc. diffuser

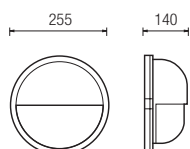

IRON

Apparecchio per interni ed esterni costituito da:

- Corpo in alluminio pressofuso verniciato
- Griglia o anello in metallo verniciato
- Diffusore in vetro satinato
- Parabola riflettente in alluminio
- Guarnizione in EPDM
- Viti di chiusura in acciaio inox
- Verniciatura in polveri poliestere ad elevata resistenza ai raggi ultravioletti e alla corrosione

Indoor and outdoor luminaire constructed of:

- Painted die-cast aluminium body
- Painted metal grid or bezel
- Satin glass diffuser
- Aluminium reflector
- EPDM gasket
- Stainless steel screws
- Painting using high resistance to UV and corrosion polyester powders



Colori - Colours

- X=2 Bianco
White
- X=3 Nero
Black

Diffusore - Diffuser

Codice-Code 00 905
per/for Cod. 904/905

Codice-Code 00 901
per/for Cod. 900/901

Codice-Code 00 903
per/for Cod. 902/903

Codice-Code 00 913
per/for Cod. 912/913

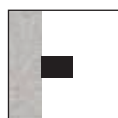

Installazione a parete
Wall mounting



Installazione a soffitto
Ceiling mounting

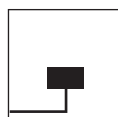

Entrata singola cavi di alimentazione
Single power supply cables input

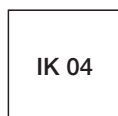

IK 04



0904 Ø 240
0900 Ø 190

0904.00X	LED	10W	E27
0900.00X	LED	7W	E27

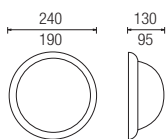

0905 Ø 240
0901 Ø 190

0905.00X	LED	10W	E27
0901.00X	LED	7W	E27

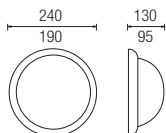

0912 27x16
0902 21x21

0912.00X	LED	10W	E27
0902.00X	LED	7W	E27

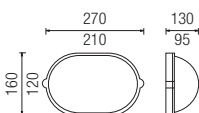

0913 27x16
0903 21x21

0913.00X	LED	10W	E27
0903.00X	LED	7W	E27

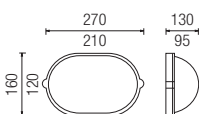





LUCY



K90



BIP

LUCY

Apparecchio per interni ed esterni
costituito da:

- Corpo in materiale termoplastico
- Diffusore in policarbonato satinato
- Parabola riflettente in alluminio
- Viti di chiusura in acciaio inox
- Verniciatura in polveri poliestere ad elevata resistenza ai raggi ultravioletti e alla corrosione

Indoor and outdoor luminaire
constructed of:

- Thermoplastic body
- Satin polycarbonate diffuser
- Aluminium reflector
- Stainless steel screws
- Painting using high resistance to UV and corrosion polyester powders



Colori - Colours

X=2  Bianco
White

X=3  Nero
Black

X=4  Silver

Diffusore - Diffuser

Codice-Code 08 9090

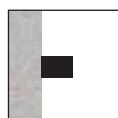

Installazione a parete
Wall mounting



Installazione a soffitto
Ceiling mounting

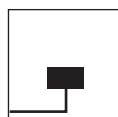

Entrata singola cavi di alimentazione
Single power supply cables input

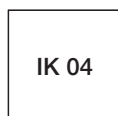

IK 04



9090

9090.00X LED 8W E27

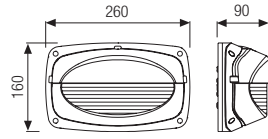

9091

9091.00X LED 8W E27

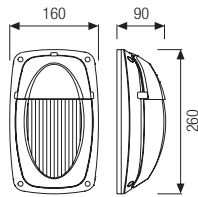

9092

9092.00X LED 8W E27

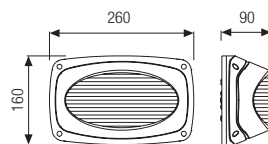

K90 - BIP

Apparecchio per interni ed esterni costituito da:

- Corpo in materiale termoplastico - K90
- Base in alluminio pressofuso verniciato bianco - Bip
- Diffusore in vetro satinato
- Parabola riflettente in alluminio solo per versione incandescenza
- Viti di chiusura in acciaio inox



Indoor and outdoor luminaire constructed of:

- Thermoplastic body - K90
- White-painted die-cast aluminium base - Bip
- Satin glass diffuser
- Aluminium reflector for incandescent version only
- Stainless steel screws



K90

Colori - Colours

- X=2  Bianco
White
- X=3  Nero
Black
- X=4  Silver

BIP

Colori - Colours

- X=3  Nero
Black
- X=4  Silver

Diffusore - Diffuser

Codice-Code 00 9030

Codice-Code 00 9080

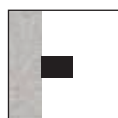

Installazione a parete
Wall mounting



Cod. 9052
Installazione a soffitto
Ceiling mounting

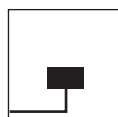

Entrata singola cavi di alimentazione
Single power supply cables input

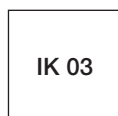



9050

9050.00X LED 8W E27

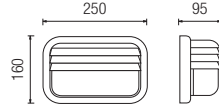

9051

9051.00X LED 8W E27

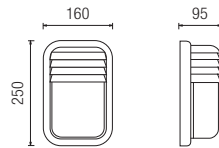

9052

9052.00X LED 8W E27

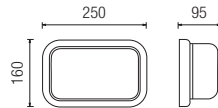

9080

9080.00X LED 6W E27

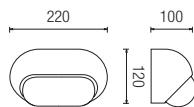





MARINA

MARINA

Apparecchio per interni ed esterni
costituito da:

- Corpo in ottone pressofuso
- Griglia in ottone pressofuso
- Diffusore in vetro satinato
- Viti di chiusura in ottone

Indoor and outdoor luminaire
constructed of:

- Die-cast brass body
- Die-cast brass grid
- Satin glass diffuser
- Brass screws



Diffusore - Diffuser
Codice-Code 00 1190
Codice-Code 00 M85
Codice-Code 00 M86
Codice-Code 00 M87
Codice-Code 00 M88

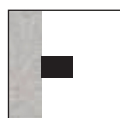

Installazione a parete
Wall mounting



Installazione a soffitto
Ceiling mounting

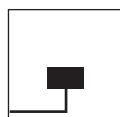

Entrata singola cavi di alimentazione
Single power supply cables input

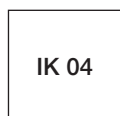

IK 04

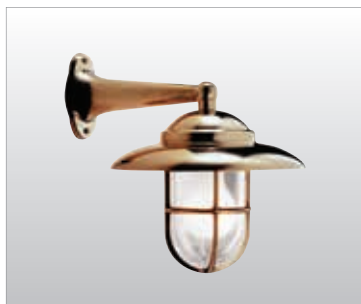

1190

1190.000 LED 10W E27

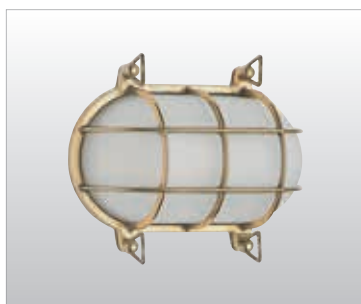
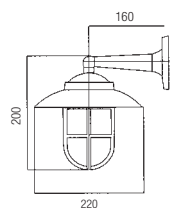

M86

M86.000 LED 10W E27

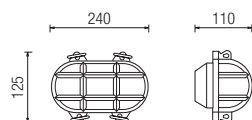

M88

M88.000 LED 10W E27

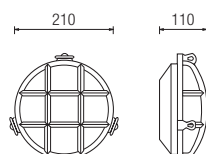





PERLA



PERLA

Plafoniera da soffitto o da parete
costituito da:

- Base in metallo verniciato bianco
- Anello in ABS UV
- Diffusore in vetro o in policarbonato

Ceiling or wall luminaire
constructed of:

- White-painted metal base
- Self-extinguishing ABS UV
- Glass or polycarbonate diffuser



Colori - Colours

X=2  Bianco
White

X=3  Nero
Black

X=4  Silver

**Le lampadine vengono fornite
solo su richiesta**

Bulbs supplied only on request



Installazione a parete
Wall mounting



Installazione a soffitto
Ceiling mounting

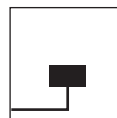

Entrata singola cavi di alimentazione
Single power supply cables input

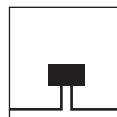

Cod. 0859 - 3081 - 9381
**Doppia entrata cavi
di alimentazione**
Double power supply
cable input

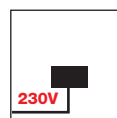

LED
Led a tensione di rete 230/240V 50/60Hz.
**Connessione diretta alla rete di alimentazione
senza necessità di alimentatore.**
LED's direct operation at 230/240V 50/60Hz.
No power supply is required.

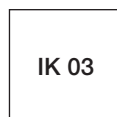

IK 03





9380

Diffusore in vetro o in policarbonato
Glass or polycarbonate diffuser

9380.00X	LED	10W	E27
-----------------	-----	-----	-----

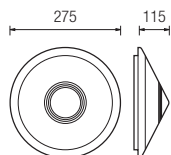

9381

Diffusore in vetro
Glass diffuser

9381.00X	LED	2x12W	E27
9381.66X	LED	21,6W	2500 lm 4000 K
9381.67X	LED	21,6W	2500 lm 3000 K

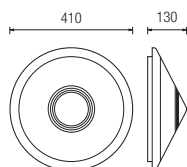

Diffusori - Diffuser

Codice-Code	00 9380	per/for	Cod. 9380	Vetro/Glass
Codice-Code	08 9380	per/for	Cod. 9380	Polic./Polyc.
Codice-Code	00 9381	per/for	Cod. 9381	Vetro/Glass

PERLA

PERLA



0859

Diffusore in vetro o in policarbonato
Glass or polycarbonate diffuser

0859.00X	LED	2x12W	E27
0859.66X	LED	21,6W	2500 lm 4000 K
0859.67X	LED	21,6W	2500 lm 3000 K

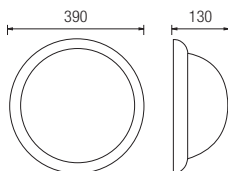

0860

Diffusore in vetro o in policarbonato
Glass or polycarbonate diffuser

0860.00X	LED	10W	E27
-----------------	-----	-----	-----

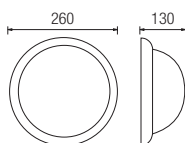

0861

Diffusore in vetro
Glass diffuser

0861.00X	LED	4,5W	E14
-----------------	-----	------	-----

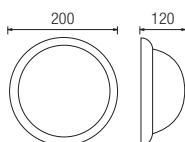

Diffusori - Diffuser

Codice-Code	00 859	per/for	Cod. 0859	Vetro/Glass
Codice-Code	00 860	per/for	Cod. 0860	Vetro/Glass
Codice-Code	00 861	per/for	Cod. 0861	Vetro/Glass
Codice-Code	08 3020	per/for	Cod. 0860	Polic./Polyc.



3088

Diffusore in vetro o in policarbonato
Glass or polycarbonate diffuser

3088.00X	LED	10W	E27
-----------------	-----	-----	-----

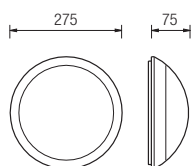

3081

Diffusore in vetro a nido d'ape
Patterned glass diffuser

3081.00X	LED	2x12W	E27
3081.66X	LED	21,6W	2500 lm 4000 K
3081.67X	LED	21,6W	2500 lm 3000 K

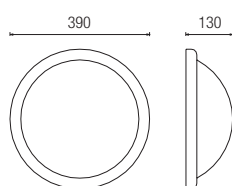

Diffusori - Diffuser

Codice-Code	00 3080	per/for	Cod. 3080	Vetro a nido d'ape/Patterned glass
Codice-Code	00 3081	per/for	Cod. 3081	Vetro a nido d'ape/Patterned glass
Codice-Code	00 1000	per/for	Cod. 3088	Vetro liscio/Smooth glass
Codice-Code	08 1000	per/for	Cod. 3088	Polic./Polyc.

Classificazione apparecchi Technical characteristics

Classificazione secondo l'infiammabilità del piano d'appoggio.
Classification on the basis of the flammability of the supporting surface.

Apparecchi non idonei al montaggio diretto su superfici normalmente infiammabili (adatti solo al montaggio su superfici non combustibili).

Luminaires not suitable for direct mounting on normally flammable surfaces (suitable only for mounting on non-combustible surfaces).



Per montaggio su superfici
Surface mounted



Per montaggio incassato
Recessed



Apparecchio non idoneo ad essere ricoperto di materiale termicamente isolante.
Luminaire not suitable for covering with thermally insulating material.

Classificazione secondo il grado di isolamento elettrico.

Classification on the basis of the class of electrical insulation.

Classe I - Class I

Apparecchio con isolamento elettrico fondamentale. Deve essere collegato al circuito di terra dell'impianto elettrico generale.

Electrical device with basic electrical insulation. Must be connected to the ground circuit of the main electrical system.

Classe II - Class II



Apparecchio con doppio isolamento elettrico. Non necessita di collegamento al circuito di terra dell'impianto elettrico generale.

Electrical device with double insulation. Need not be connected to the ground circuit of the main electrical system.

Classe III - Class III



Apparecchio in cui la protezione contro la scossa elettrica si basa su una alimentazione a bassissima tensione di sicurezza (SELV) o su una alimentazione a bassissima tensione di protezione (PELV) e in cui non vengono generate tensioni più alte della SELV o della PELV.

Luminaire in which protection against electric shock relies on supply at safety extra-low voltage (SELV) or protective extra-low voltage (PELV) and in which voltages higher than those of SELV or PELV are not generated.



Distanza minima di installazione dagli oggetti illuminati.

Minimum distance from lighted objects.



CODICE IK Sistema di classificazione dei gradi di protezione degli involucri contro gli impatti meccanici.

IK CODE System for classifying the degrees of protection provided by the enclosure against mechanical impacts.

Energia di impatto (J) / Impact Energy (J)

IK01	IK02	IK03	IK04	IK05
0,15	0,2	0,35	0,5	0,7

IK06	IK07	IK08	IK09	IK10
1	2	5	10	20

Grado di protezione IP Protection index

Il grado di protezione degli apparecchi di illuminazione viene indicato dalla sigla IP (international protection) seguita da due cifre di cui, la prima indica il grado di protezione contro l'ingresso dei corpi solidi e la seconda dei liquidi. Esempio: IP54 indica che l'apparecchio ha protezione 5 contro la penetrazione di solidi e 4 contro la penetrazione d'acqua.

The degree of protection of light fixtures is indicated by the letters IP (international protection) followed by two figures, the first of which indicates the index of protection against the penetration of solid bodies and the second of liquids. For example: IP54 indicates that the device has an index of protection 5 against the penetration of solids and 4 against the penetration of water.

Protezione dai solidi - Prima cifra IP

Protection against solids - First IP figure

0 Non protetto - Not protected

1 Protetto dalla penetrazione di corpi solidi di dimensioni maggiori a 50 mm

Protected against penetration of solid bodies measuring more than 50 mm

2 Protetto dalla penetrazione di corpi solidi di dimensioni maggiori a 12 mm

Protected against penetration of solid bodies measuring more than 12 mm

3 Protetto dalla penetrazione di corpi solidi di dimensioni maggiori a 2,5 mm

Protected against penetration of solid bodies measuring more than 2.5 mm

4 Protetto dalla penetrazione di corpi solidi di dimensioni maggiori a 1 mm

Protected against penetration of solid bodies measuring more than 1 mm

5 Protetto contro la polvere

Protected against dust

6 Stagno contro la polvere

Sealed against dust

Protezione dai liquidi - Seconda cifra IP

Protection against liquids - Second IP figure

0 Non protetto - Not protected

1 Protetto contro gocce d'acqua che cadono verticalmente

Protected against drops of water falling vertically

2 Protetto contro gocce d'acqua che cadono con inclinazione massima di 15°

Protected against drops of water falling with a maximum angle of 15°

3 Protetto contro la pioggia

Protected against rain

4 Protetto contro gli spruzzi

Protected against splashes

5 Protetto contro i getti d'acqua

Protected against jets of water

6 Protetto contro le ondate

Protected against waves

7 Protetto contro l'immersione

Protected against immersion

8 Protetto contro la sommersione

Protected against submersion

IPX9 (80 °C)

Protetto contro i getti d'acqua ad alta pressione e alta temperatura

High pressure and temperature water jet-proof.

IPX9 (15 °C)

Protetto contro i getti d'acqua ad alta pressione e bassa temperatura

High pressure and cold water jet-proof.

Omologazioni Quality marking

Marcatura CE
CE marking



Tutti i prodotti sono conformi alle norme EN 60598-1 e alle parti seconde applicabili nonché alle norme EMC applicabili.

La marcatura CE, applicata sugli articoli, testimonia la conformità alle direttive Europee: 73/23 CEE, 93/68 CE, 2006/95/CE, 2014/35/UE (direttiva di bassa tensione) 89/336 CEE, 93/68 CE, 2004/108/CE, 2014/30/UE (direttiva di compatibilità elettromagnetica).

All the products are in compliance with EN 60598-1 and part two applicable standards and to EMC applicable standards.

The CE marking, applied on the products, certifies their conformity with the European directives:

73/23 CEE, 93/68 CE, 2006/95/CE, 2014/35/UE (Low Voltage Directive).

89/336 CEE, 93/68 CE, 2004/108/CE, 2014/30/UE (Electromagnetic Compatibility Directive).

RoHs

Apparecchi conformi alla direttiva 2011/65/UE RoHs (direttiva sulla restrizione dell'uso di sostanze pericolose) direttiva (EU) 2015/863.

Appliances in compliance with directive 2011/65/UE RoHs (directive on the restriction of the use of certain hazardous substances) directive (EU) 2015/863.

RAEE

Gli apparecchi devono essere smaltiti a fine vita conformemente a quanto prescritto dalla direttiva 2012/19/UE RAEE (direttiva sui rifiuti di apparecchiature elettriche ed elettroniche).

At the end of their life, the appliances shall be disposed according to the requirements of 2012/19/UE WEEE and its amendments (directive on waste of electrical and electronic equipment).

ErP

Prodotti in conformità con la direttiva 2009/125/CE ErP (Energy related Products) ed ai regolamenti (UE) 2019/2020 e (UE) 2021/341 riguardanti la progettazione ecocompatibile dei prodotti.

Products in conformity with 2009/125/EC ErP (Energy related Products) and regulations (UE) 2019/2020 and (UE) 2021/341 establishing a framework for the setting of ecodesign requirements for energy-related products.

EEL

Prodotti in conformità con i regolamenti (UE) 2019/2015 e (UE) 2021/340 EEL (Energy Efficiency Label) riguardanti l'indicazione del consumo di energia e di altre risorse dei prodotti connessi all'energia mediante l'etichettatura ed informazioni relative ai prodotti e alle sorgenti luminose impiegate negli apparecchi.

Products in conformity with (EU) 2019/2015 and (UE) 2021/340 to EEL (Energy Efficiency Label) regulations regarding indication by labelling and standard product information of the consumption of energy and other resources by energy-related products.

Simboli riguardanti la sostituibilità delle sorgenti luminose e degli alimentatori incorporati negli apparecchi

Symbols regarding to the substitutability of light sources and power supplies incorporated in the luminaires



Sorgente luminosa sostituibile solo da un professionista.
Replaceable light source by a professional.



Sorgente luminosa sostituibile (solo LED) da un professionista.
Replaceable (LED only) light source by a professional.



Alimentatore sostituibile da un professionista.
Replaceable control gear by a professional.



Sorgente sostituibile dall'utilizzatore finale.
Replaceable light source by an end-user.



Sorgente (solo LED) sostituibile dall'utilizzatore finale.
Replaceable (LED only) light source by an end-user.

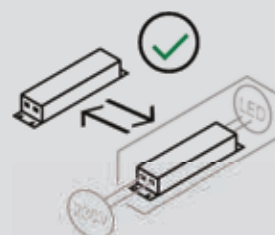

Alimentatore sostituibile da parte di un utente finale.
Replaceable control gear by an end-user.

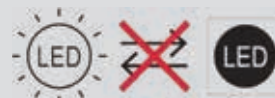

Sorgente luminosa non sostituibile.
Non-replaceable light source.

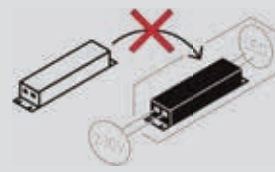

Alimentatore non sostituibile.
Non-replaceable control gear.

Omologazioni Quality marking



EN 62471:2009

Sicurezza fotobiologica delle lampade e sistemi di lampade

La norma EN 62471 definisce le linee guida per la valutazione e il controllo dei rischi fotobiologici derivanti da tutte le lampade e apparecchi di illuminazione alimentati elettricamente, compresi i LED, nella gamma di lunghezze d'onda da 200 nm a 3000 nm.

Per le apparecchiature a LED le prove di Sicurezza Fotobiologica sono obbligatorie. Se l'esposizione diventa eccessiva, le radiazioni potrebbero essere causa di rischi per gli organi del corpo umano che sono più esposti, cioè la cute e gli occhi.

La norma definisce quattro gruppi di rischio:

- gruppo esente = assenza di rischio
- gruppo 1 = rischio basso
- gruppo 2 = rischio moderato
- gruppo 3 = rischio alto.

Tutti i nostri prodotti sono conformi alle norme EN 62471:2009 e rientrano, salvo indicazione contraria, nel "gruppo esente" o nel "gruppo 1", pertanto sono utilizzabili senza particolari precauzioni rispetto a rischi foto biologici.

Photobiological safety of lamps and lamp systems. The standard EN 62471 defines the guidelines for the evaluation and control of photobiological hazards arising from all lamps and lighting fixtures electrically powered, including the LED, in the range of wavelengths from 200 nm to 3000 nm.

For LED equipment Photobiological tests are mandatory.

If the exposure becomes excessive, the radiation may cause injuries to the organs of the human body that are most exposed, i.e. the skin and eyes.

The standard defines four risk groups:

- Exempt group = Absence of risk
- Risk Group 1 = low-risk
- Risk Group 2 = moderate-risk
- Risk Group 3 = high-risk.

All our products conform to standards EN 62471:2009 and are classified, unless otherwise stated, in the "exempt group" or "group 1", therefore can be used without special precautions against photobiological risks.

Norma tecnica CEI EN 60598-2-13 per apparecchi interrati

Il significato della numerazione riportata nel catalogo, a fianco dei dati di lampada degli apparecchi interrati, è derivato dalla "GUIDA ALLA BUONA INSTALLAZIONE" riportata nell'allegato A della norma EN 60598-2-13.

Si invita l'installatore a consultare e tenere in considerazione tale norma nonché le norme di impianto applicabili e vigenti.

ZONA 1 - Impiego previsto nelle aree normalmente non accessibili (in conformità alle Norme Impianti)

ZONA 2 - In aree ad accesso limitato (ad esempio riservate ai pedoni e ai ciclisti)

ZONA 3 - In tutte le altre aree accessibili (ad esempio su vie carrabili, parcheggi, etc.)

ZONA 4 - Come sopra, ma in aree in cui sono utilizzati spazzaneve e/o agenti decongelanti

ZONA 5 - In aree particolari (in cui le temperature di funzionamento possono provocare lesioni, ad esempio in ambienti per bambini, etc.).

Standard CEI EN 60598-2-13 for ground recessed luminaires

The meaning of numbering in the catalogue besides of the lamp rating of the ground recessed luminaires is derived from the "GUIDE TO GOOD INSTALLATION PRACTICE" in the annex A of the EN 60598-2-13.

Installer is strongly required to consult and take into account that standard as well as the electrical installation of building applicable and in force standards.

ZONE 1 - In normally non-accessible areas (according to Wiring Rules)

ZONE 2 - In restricted accessible areas (e.g. pedestrians and pedal cycles only)

ZONE 3 - In all other accessible areas (e.g. carriageways, parkings, etc.)

ZONE 4 - As above, but in areas for snow-ploughs and / or de-icing agents

ZONE 5 - In particular areas (where working temperatures may cause injuries, e.g. nurseries, etc.)

INDICE

INDEX

Codice	pagina	Codice	pagina	Codice	pagina	Codice	pagina	Codice	pagina
0859	344	1095	203	2096	247	3087	295	4032	89
0860	344	1096	203	2097	247	3088	345	4033	89
0861	344	1097	203	2100	271	3090	307	4036	89
0900	329	1099	202	2101	271	3091	307	4038	89
0901	329	1190	339	2102	271	3801	127	4040	81
0902	329	1210	7	2610	256	3802	127	4052	209
0903	329	1211	7	2611	256	3804	127	4054	209
0904	329	1305	73	2612	257	3805	127	4058	209
0905	329	1308	73	2614	257	3810	25	4080	261
0912	329	1310	69	2615	257	3811	25	4082	261
0913	329	1400	73	2616	255	3812	25	4086	261
1000	299	1405	73	2618	255	3813	25	4090	191
1001	299	1408	73	2619	257	3814	27	4091	191
1002	299	1414	193	2810	267	3815	27	4092	191
1003	299	1415	193	2811	267	3816	27	4094	191
1004	299	1416	193	2812	267	3817	27	4270	153
1005	299	1418	193	3000	325	3820	57	4271	153
1006	301	1420	193	3001	325	3822	57	4301	133
1007	301	1618	291	3011	265	3824	127	4302	133
1008	301	1620	291	3012	325	3825	127	4304	129
1010	201	1780	217	3015	265	3830	57	4305	129
1011	202	1781	217	3017	265	3832	57	4306	130
1015	195	1782	217	3020	321	3840	19	4307	130
1016	195	1783	217	3021	321	3841	19	4308	131
1020	161	1810	7	3022	321	3842	19	4310	137
1022	161	1811	7	3024	67	3843	19	4311	137
1030	161	1812	7	3025	67	3844	21	4312	137
1032	161	2000	275	3026	69	3845	21	4321	53
1034	199	2001	275	3031	91	3846	21	4322	53
1035	199	2002	275	3032	91	3847	21	4330	221
1036	199	2003	273	3033	91	3850	139	4331	221
1037	199	2004	273	3034	91	3851	139	4332	221
1038	199	2005	277	3035	93	3860	43	4470	153
1039	199	2006	277	3036	93	3861	43	4471	153
1045	181	2007	277	3038	93	3862	43	4913	324
1050	161	2008	273	3040	297	3870	47	5014	177
1057	181	2010	213	3041	297	3873	47	5015	177
1060	311	2011	213	3042	297	3875	47	5016	177
1061	311	2015	195	3050	237	3876	47	5020	249
1062	311	2016	195	3051	237	3878	47	5021	249
1070	155	2020	213	3052	237	3880	43	5022	249
1071	155	2024	213	3056	237	3881	43	5024	179
1078	157	2031	279	3060	151	3882	43	5025	179
1079	157	2035	279	3065	151	3905	325	5026	179
1080	215	2037	279	3069	151	4000	324	5030	249
1081	215	2039	279	3070	49	4001	324	5031	249
1082	215	2060	149	3071	49	4011	187	5040	245
1083	215	2065	149	3072	49	4012	187	5041	245
1084	163	2069	149	3073	49	4014	187	5043	245
1085	163	2070	155	3074	49	4020	323	5050	207
1086	215	2071	155	3079	49	4021	323	5054	183
1088	215	2080	245	3081	345	4022	323	5056	183
1090	201	2081	245	3082	305	4023	323	5058	183
1091	201	2083	245	3083	305	4024	67	5062	247
1093	202	2092	247	3084	305	4025	67	5063	247
1094	202	2093	247	3085	305	4031	89	5066	247

Codice	pagina	Codice	pagina	Codice	pagina	Codice	pagina
5067	247	7042	251	8055	197	9064	117
5070	169	7050	109	8071	101	9067	116
5072	169	7060	109	8072	101	9068	117
5074	167	7070	233	8073	101	9069	117
5081	145	7071	95	8074	101	9070	113
5082	145	7072	95	8081	99	9071	115
5090	147	7074	95	8082	99	9072	115
5091	147	7076	95	8083	99	9075	115
5092	171	7077	95	8091	105	9076	115
5093	171	7078	95	8092	105	9077	115
5094	143	7080	251	8093	105	9080	335
5110	11	7081	251	8130	283	9085	119
5111	11	7230	173	8131	283	9087	121
5112	11	7231	173	8132	283	9088	119
5120	15	7520	33	8133	283	9090	333
5121	15	7521	33	8134	283	9091	333
5130	15	7530	35	8140	240	9092	333
5131	15	7531	35	8141	240	9094	120
5140	15	7540	31	8142	240	9095	120
5141	15	7541	31	8146	240	9097	121
5150	13	7543	31	8840	239	9098	120
5151	13	7544	31	8841	239	9099	120
5152	13	7550	37	8842	239	9320	309
5180	229	7551	37	9000	315	9321	309
5181	229	7560	39	9001	315	9322	309
5182	229	7561	39	9008	315	9324	309
6012	187	7580	31	9010	315	9380	343
6014	187	7581	31	9011	327	9381	343
6020	77	7590	31	9014	327	M86	339
6021	77	7591	31	9015	119	M88	339
6024	77	8010	300	9016	119		
6060	81	8011	300	9017	119		
6061	61	8012	300	9018	119		
6062	61	8014	295	9020	315		
6063	61	8015	295	9021	315		
6064	61	8020	103	9024	121		
6065	61	8021	103	9025	121		
6066	61	8022	103	9030	317		
6071	63	8023	103	9031	317		
6072	63	8030	283	9032	317		
6075	63	8031	283	9033	317		
6076	63	8032	283	9034	317		
7010	109	8033	283	9035	327		
7011	123	8034	283	9036	327		
7012	123	8040	241	9037	327		
7013	123	8041	241	9039	287		
7014	123	8042	241	9040	287		
7017	123	8045	225	9042	287		
7020	109	8046	241	9044	288		
7021	85	8047	225	9047	288		
7022	85	8049	225	9048	288		
7024	85	8050	197	9050	335		
7025	85	8051	197	9051	335		
7027	123	8052	197	9052	335		
7040	251	8053	197	9061	116-117		
7041	251	8054	197	9062	116		

Il flusso luminoso indicato è quello dei LED impiegati.
Lumen rating is related to the flux emitted by the LED module.

Le curve fotometriche sono consultabili sul nostro sito internet www.boluce.it
For informations about photometries please refer to www.boluce.it



MADE IN ITALY

**Il presente catalogo non può essere riprodotto neppure parzialmente. Tutti i diritti sono riservati.
I dati nominali, le potenze, le fotografie, la descrizione degli apparecchi, le quote e le dimensioni menzionati in questo catalogo
sono a titolo indicativo e non costituiscono alcun impegno per la nostra società,
che si riserva di apportare, senza preavviso, tutte le modifiche che riterrà opportune.
I prodotti presenti in questo catalogo sono REGISTRATI.**

No part of this catalogue may be reproduced. All rights reserved.
Rating, power, pictures, description of the fittings, heights and dimensions mentioned in this catalogue
are approximate and do not constitute any commitment on our part, and we reserve the right
to make any modifications we consider appropriate without prior notice.
The products in this catalogue are PATENTED.

**Questo catalogo è stato stampato secondo la filosofia GreenPrinting®
volta alla salvaguardia dell'ambiente attraverso l'uso di materiali
(lastre, carta, inchiostri e imballi) a basso impatto ambientale,
oltre all'utilizzo di energia rinnovabile e automezzi a metano.**

This catalogue has been printed in accordance with the GreenPrinting®
philosophy, aimed at protecting the environment via the use of
materials (plates, paper, ink and packaging) with a low
environmental impact, as well as the use of renewable energy sources
and vehicles fuelled by natural gas.

